

**Artemide<sup>®</sup>**

ARCHITECTURAL



# AULIX lighting

návrhy osvětlení a prodej svítidel  
inteligentní systémy, vypínače

## SVĚTELNÉ STUDIO

Náměstí Na Sádkách 705  
252 41 Dolní Břežany (Praha západ)

Telefon: +420 246 083 152

Mobil.: +420 702 061 783

E-mail: [studio@aulix.cz](mailto:studio@aulix.cz)

Web: [www.aulix.cz](http://www.aulix.cz)

E-shop: <http://obchod.aulix.cz>

Sledujte nás také na sociálních sítích:



↳ THE HUMAN AND RESPONSIBLE LIGHT

# Indoor



182	37 Cube	186	PAD
298	A.24	256	PAD 80
368	A.39	516	PAD System
408	Algoritmo	280	Parabola
580	Alphabet of Light	82	Picto
638	Ameluna	278	Picto Recessed
158	Caelum	286	Rastaf
486	Calipso	464	Series Y
112	Cata	202	Sharp
530	Chocolate	566	Silent Field 2.0
524	Chocolate Floor	458	Smart Office
618	Discovery	532	Surf System
634	Discovery Space	538	Surf Wall
540	Eggboard	650	Tagora
226	Everything	194	Track
504	Grafa System	522	Uglare19
136	Hoy	170	Una Pro
96	LoT	240	Una Pro 75
264	Luceri LED	250	Una Pro 150
668	Mouette	44	Vector
572	Nur 1618 Acoustic	290	Zeno UP
128	Olmo	294	Zeno Up Frosted

# Outdoor



844	Aria	724	Ippolito
708	Antartikòs	884	LineaLed - drive over
734	Basolo	888	LineaLed - wallwasher
772	Calumet	834	Megara
934	Cariddi	842	Microled
938	Cariddi palo	858	Minispot
924	Cefiso	776	Molla
930	Cefiso palo	740	Niki
760	Chilone	746	Nuda
754	Ciclope	678	"O"
736	Cuneo	874	Obice
892	Dedalo	730	Oblique
744	Dioscuri	726	Piroscafo
778	Effetto	916	Poto
798	Ego downlight	712	Reeds
816	Ego walk/drive over	906	Solar Tree 2.0
862	Ego spot	896	Solar Tree 2 <sup>nd</sup> Generation
866	Epulo	920	Sostituto palo
848	Faci	918	Sostituto spot
852	Faci Vetro	880	Spike
870	Falange	720	Tetragono
768	Granito	788	Tolomeo Outdoor
914	Indicta	784	Tolomeo XXL
		690	Walking

## Indoor



projector \_\_\_\_\_ 40

downlighting \_\_\_\_\_ 200

professional lighting \_\_\_\_\_ 296

## Outdoor



general lighting \_\_\_\_\_ 578

general lighting path \_\_\_\_\_ 676

downlighting walk/drive over lighting \_\_\_\_\_ 796

projector \_\_\_\_\_ 856

scenographic lighting \_\_\_\_\_ 878

## Technical



places and street lighting \_\_\_\_\_ 894

940







**CEILING**

	
298 A.24	96 LoT
	
368 A.39	106 LoT Reflector
	
408 Algoritmo	186 PAD
	
444 A.Sharping	256 PAD 80
	
486 Calipso	82 Picto
	
112 Cata	650 Tagora
	
112 Cata	170 Una Pro
	
560 Eggboard Baffle	240 Una Pro 75
	
136 Hoy	250 Una Pro 150

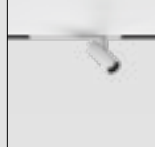
**CEILING RECESSED - SEMI RECESSED**

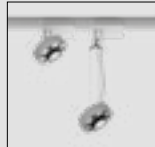
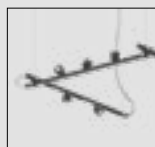
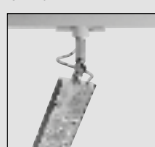
		
182 37 Cube	96 LoT	652 Tagora
		
298 A.24	96 LoT Reflector	522 Uglare19
		
368 A.39	264 Luceri LED	170 Una Pro
		
408 Algoritmo	186 PAD	240 Una Pro 75
		
444 A.Sharping	256 PAD 80	290 Zeno Up
		
158 Caelum	280 Parabola	294 Zeno Up Frosted
		
226 Everything	278 Picto Recessed	
		
136 Hoy	286 Rastaf	
		
136 Hoy	202 Sharp	







**TRACK**

298 A.24

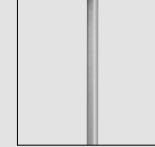
112 Cata

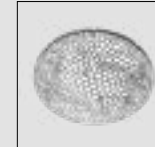
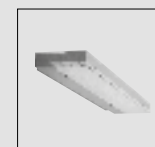
136 Hoy

96 LoT

128 Olmo

186 PAD

82 Picto

170 Una Pro

44 Vector

**SUSPENSION**

		
298 A.24	634 Discovery Space	128 Olmo
		
368 A.39	540 Eggboard	516 PAD System
		
408 Algoritmo	560 Eggboard Baffle	464 Series Y
		
580 Alphabet of Light	504 Grafa	566 Silent Field 2.0
		
638 Ameluna	136 Hoy	458 Smart Office
		
434 A.Sharping	96 LoT	532 Surf System
		
486 Calipso	96 LoT Reflector	650 Tagora
		
112 Cata	668 Mouette	
		
618 Discovery	572 Nur Acoustic	

**WALL**

298 A.24

408 Algoritmo

580 Alphabet of Light

486 Calipso

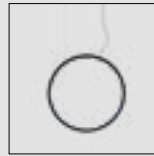
530 Chocolate Wall

618 Discovery

560 Eggboard Wall

538 Surf Wall

170 Una Pro

**FLOOR**

524 Chocolate Floor

SUSPENSION



678

"O"



788

Tolomeo Lampione



788

Tolomeo Paralume



788

Tolomeo Paralume

LINEAR PROFILE

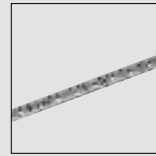

892

Dedalo

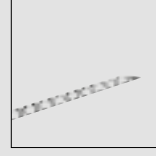

888

LineaLed Wallwasher

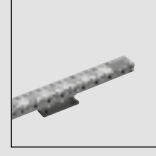

880

Spike

WALL - CEILING

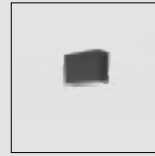

708

Antarktikòs

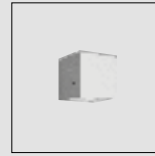

778

Effetto



730

Oblique

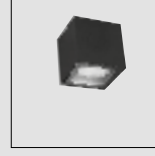

734

Basolo



862

Ego Spot



918

Sostituto Spot



772

Calumet

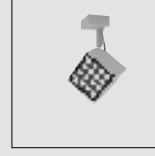

866

Epulo



720

Tetragono



934

Cariddi



870

Falange



690

Walking

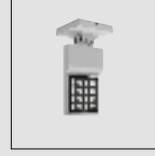

924

Cefiso



858

Minispot

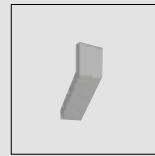

760

Chilone

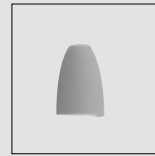

776

Molla



754

Ciclope



740

Niki



736

Cuneo



678

"O"



744

Dioscuri



874

Obice

WALL RECESSED



844

Aria



754

Ciclope



848

Faci



852

Faci Vetro



746

Nuda

CEILING RECESSED



844

Aria

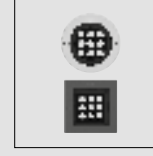

798

Ego downlight



812

Ego Vetro downlight

GROUND RECESSED

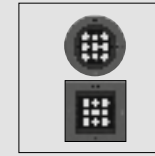

816

Ego drive/walk over

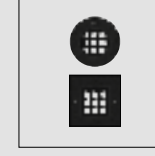

830

Ego Vetro walk over



884

LineaLed drive over



834

Megara

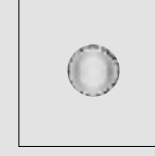

842

Microled

FLOOR - BOLLARD

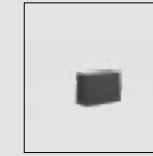

708

Antarktikòs



870

Falange

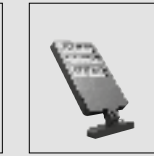

918

Sostituto spot

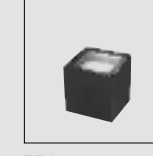

734

Basolo



768

Granito

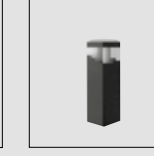

720

Tetragono



934

Cariddi

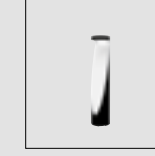

724

Ippolito

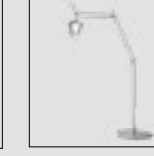

788

Tolomeo Lampione

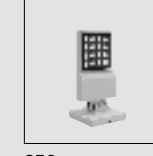

930

Cefiso



858

Minispot

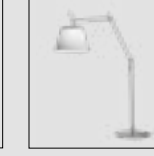

788

Tolomeo Paralume



760

Chilone



746

Nuda



784

Tolomeo XXL



754

Ciclope



678

"O"

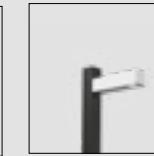

690

Walking

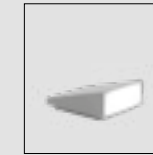

736

Cuneo



730

Oblique

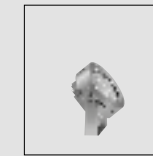

862

Ego Spot



726

Piroscrafo

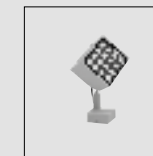

866

Epulo

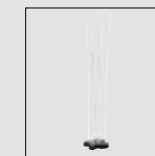

712

Reeds

POLE

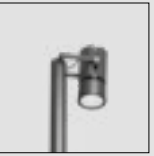

938

Cariddi pole



930

Cefiso pole



760

Chilone pole



914

Indicta



916

Poto



906

Solar Tree 2.0



896

Solar Tree 2<sup>nd</sup> Gen.

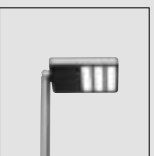

920

Sostituto pole

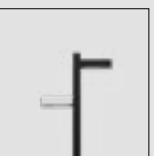

690

Walking

PROJECTOR



182  
37 Cube



82  
Picto



158  
Caelum



170  
Una Pro



112  
Cata



240  
Una Pro 75



136  
Hoy

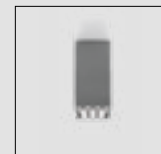

250  
Una Pro 150



96  
LoT



44  
Vector



96  
LoT Reflector

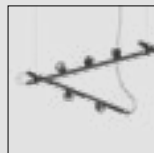

128  
Olmo



186  
PAD



256  
PAD 80

DOWNLIGHTING

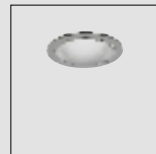

226  
Everything

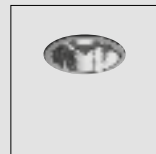

264  
Luceri LED



280  
Parabola



278  
Picto Recessed

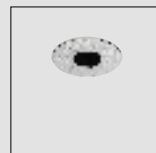

286  
Rastaf



202  
Sharp

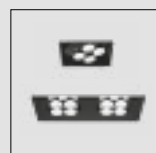

240  
Una Pro 75



290  
Zeno Up



294  
Zeno Up Frosted

PROFESSIONAL LIGHTING



298  
A.24

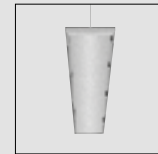

516  
PAD System

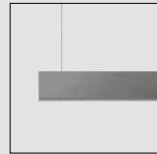

368  
A.39



464  
Series Y

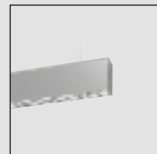

408  
Algoritmo

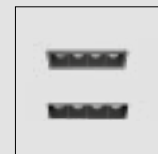

202  
Sharp



444  
A.Sharping

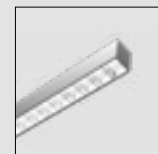

458  
Smart Office



486  
Calipso



532  
Surf System

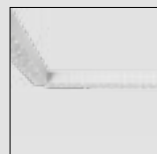

486  
Calipso Linear



522  
Uglare19

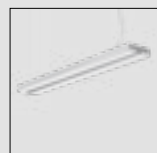

530  
Chocolate



170  
Una Pro



524  
Chocolate floor

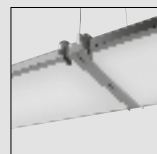

504  
Grafa System

ACOUSTIC LIGHTING

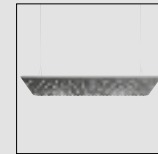

540  
Eggboard

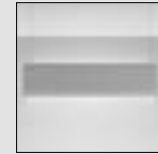

560  
Eggboard Baffle



572  
Nur 1618 Acoustic

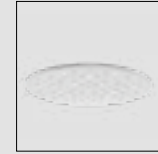

566  
Silent Field 2.0

GENERAL LIGHTING



580  
Alphabet of Light



638  
Ameluna

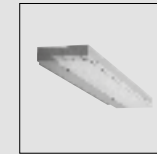

530  
Chocolate Wall



618  
Discovery



634  
Discovery Space

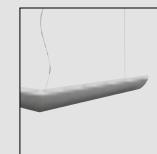

668  
Mouette

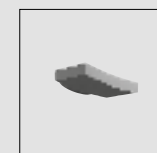

538  
Surf Wall

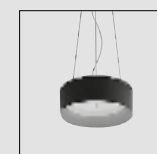

650  
Tagora



SCENOGRAPHIC LIGHTING

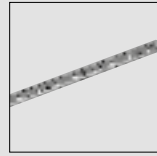

892  
Dedalo

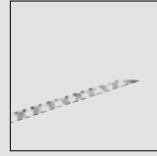

888  
LineaLed Wallwasher

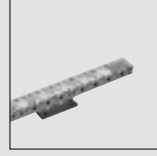

880  
Spike

ACCENT LIGHTING



934  
Cariddi

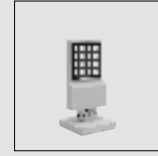

924  
Cefiso



862  
Ego spot

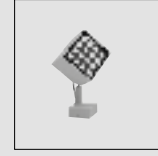

866  
Epulo



870  
Falange



858  
Minispot



874  
Obice



918  
Sostituto Spot

GRAPHIC LIGHTING

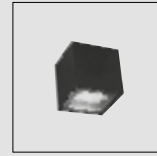

734  
Basolo



772  
Calumet



736  
Cuneo

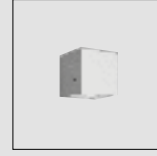

778  
Effetto



768  
Granito

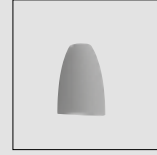

812  
Molla

INDICATOR LIGHTING

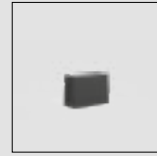

708  
Antarktikòs



844  
Aria



754  
Ciclope



848  
Faci



852  
Faci Vetro



746  
Nuda



690  
Walking

DOWNLIGHTING



844  
Aria

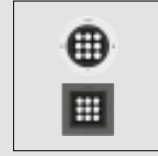

798  
Ego downlight

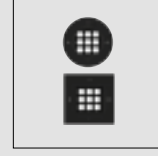

812  
Ego Vetro downlight

WALK / DRIVE OVER LIGHTING

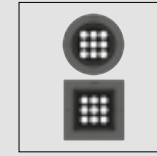

816  
Ego drive over

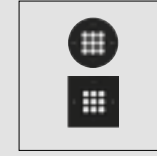

830  
Ego Vetro walk over



884  
LineaLed drive over

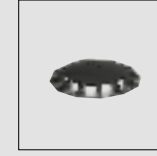

834  
Megara

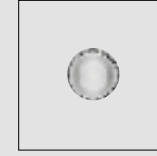

842  
Microled

GENERAL LIGHTING

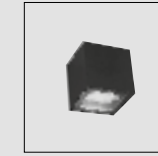

734  
Basolo

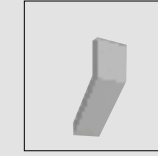

760  
Chilone

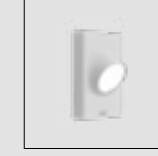

754  
Ciclope

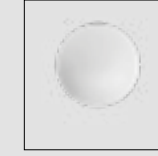

774  
Dioscuri

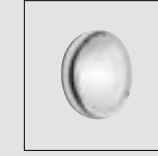

740  
Niki



730  
Oblique



720  
Tetragono

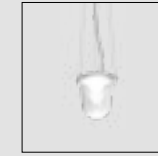

788  
Tolomeo Lampione



788  
Tolomeo Paralume

PATH LIGHTING



760  
Chilone



754  
Ciclope



724  
Ippolito

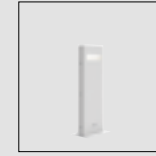

746  
Nuda



678  
"O"



730  
Oblique

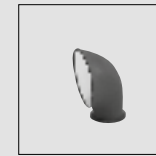

726  
Piroscrafo

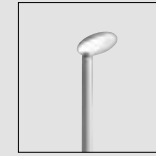

916  
Poto

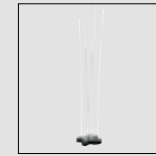

712  
Reeds

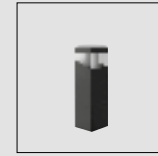

720  
Tetragono



690  
Walking

PLACES AND STREET LIGHTING



938  
Cariddi pole



930  
Cefiso pole



760  
Chilone



914  
Indicta



906  
Solar Tree 2.0



896  
Solar Tree 2<sup>nd</sup> Gen.

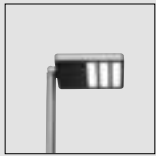

920  
Sostituto pole



784  
Tolomeo XXL

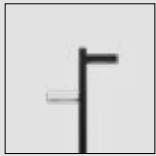

690  
Walking

# The Human and Responsible Light

The relationship between humans, light and environment has always been central to Artemide's vision. Over the years, this principle has aimed not only at the well-being of the individual and his/her perception of spaces, but also it has confronted the environmental sustainability and it has focused on understanding the attention to nature and to all living beings.

Light is the source of life. It feeds man, space, and the whole Planet. It marks the rhythms of our lives. It is an element that can sustain and improve environmental, perceptive and social quality.

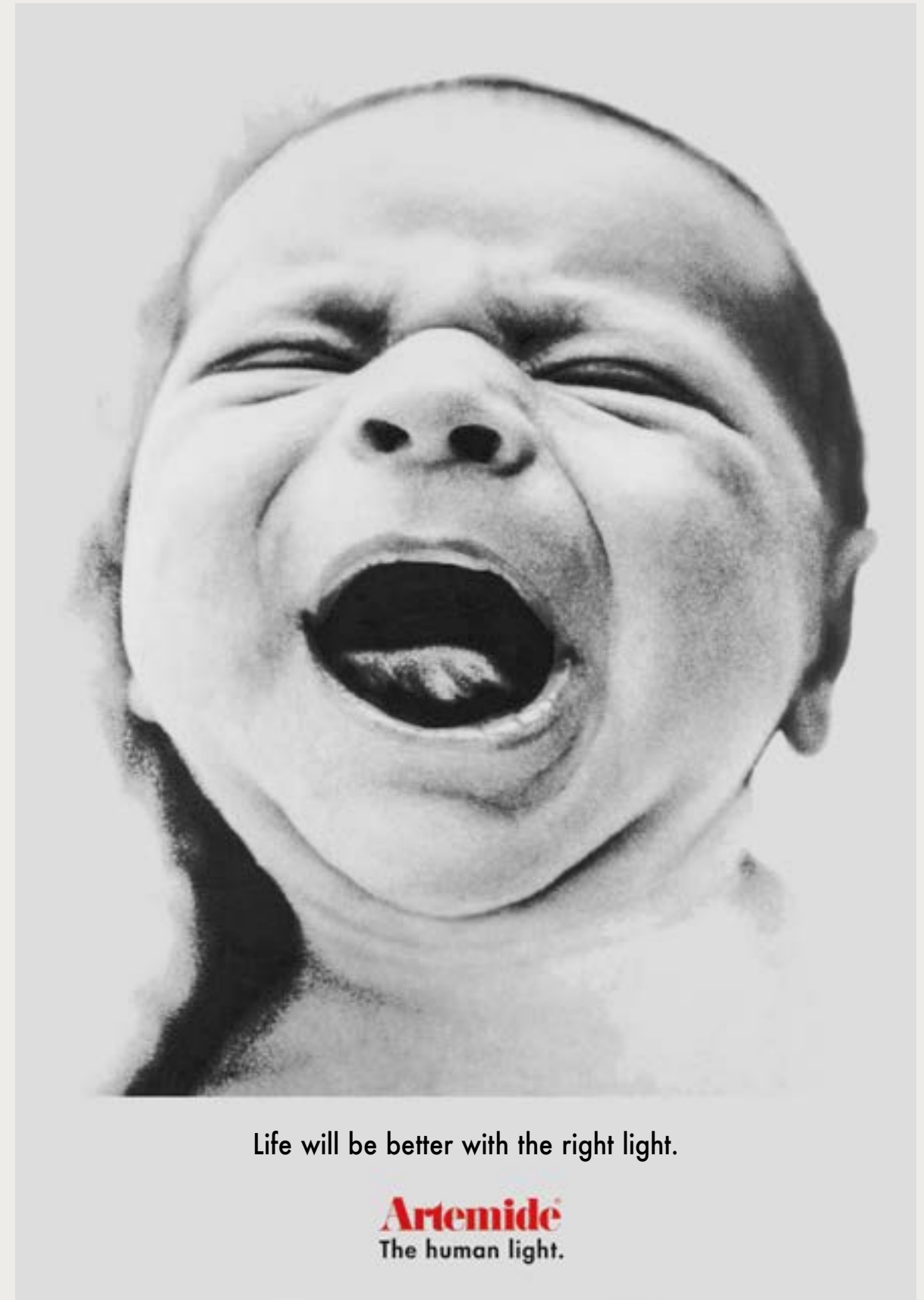

Life will be better with the right light.

**Artemide**  
The human light.

ADV Campaign, 1998

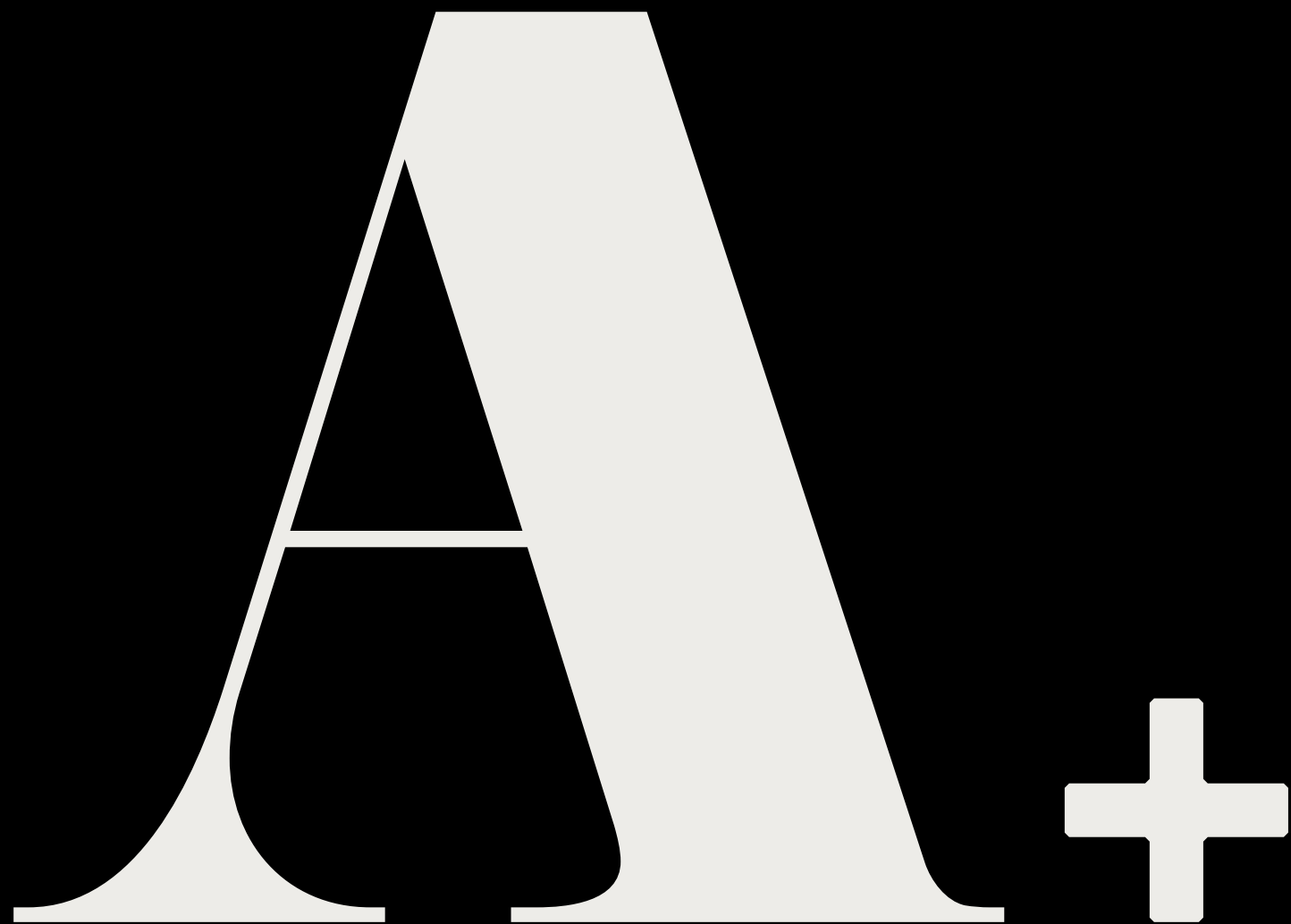

**Innovation adds up  
values to the present  
in order to shape the  
future we want to  
inhabit.**

Designing innovation means to offer a better alternative to what we already have, creating an interactive and responsive design that connects technology and science with humanistic contemporary culture.

Good design combines innovation, aesthetics, know-how, high quality of manufacturing and the greatest attention to the human and emotional relation with the object and the light effect. Design means project, not simply shape or style.

# Sustainability

↳ Sustainable light design means to be responsible for our common future

- Responsible design** Reduce to innovate: more with less. New project values become acts of responsibility towards the Planet and translate into a creative evolution: less material, no waste and less energy, without giving up performance, quality and beauty. A more efficient and critical approach that gets to the core of the project.
- Enduring projects** Enduring Project: the emancipation from the logics of consumption, through a lasting partnership with matter. A careful selection of innovative materials and an intelligent project help create a dynamic emotional bond with the product. Enduring project means quality.
- Incremental system** Incremental System: the project as an open platform. We intend the product as something that is never finished, an open positive system that can constantly grow through physical maintenance and the upgrading of parameters.
- Re-connecting to nature** From energy to nature: re-connecting to nature. Light is indispensable energy for the life of humanity and all organisms. It has significant repercussions on nature by helping its growth and all the photo-biological processes. By studying light and its relation to humankind, space and environment, we can get towards the definition of a light that takes care of all living organisms.

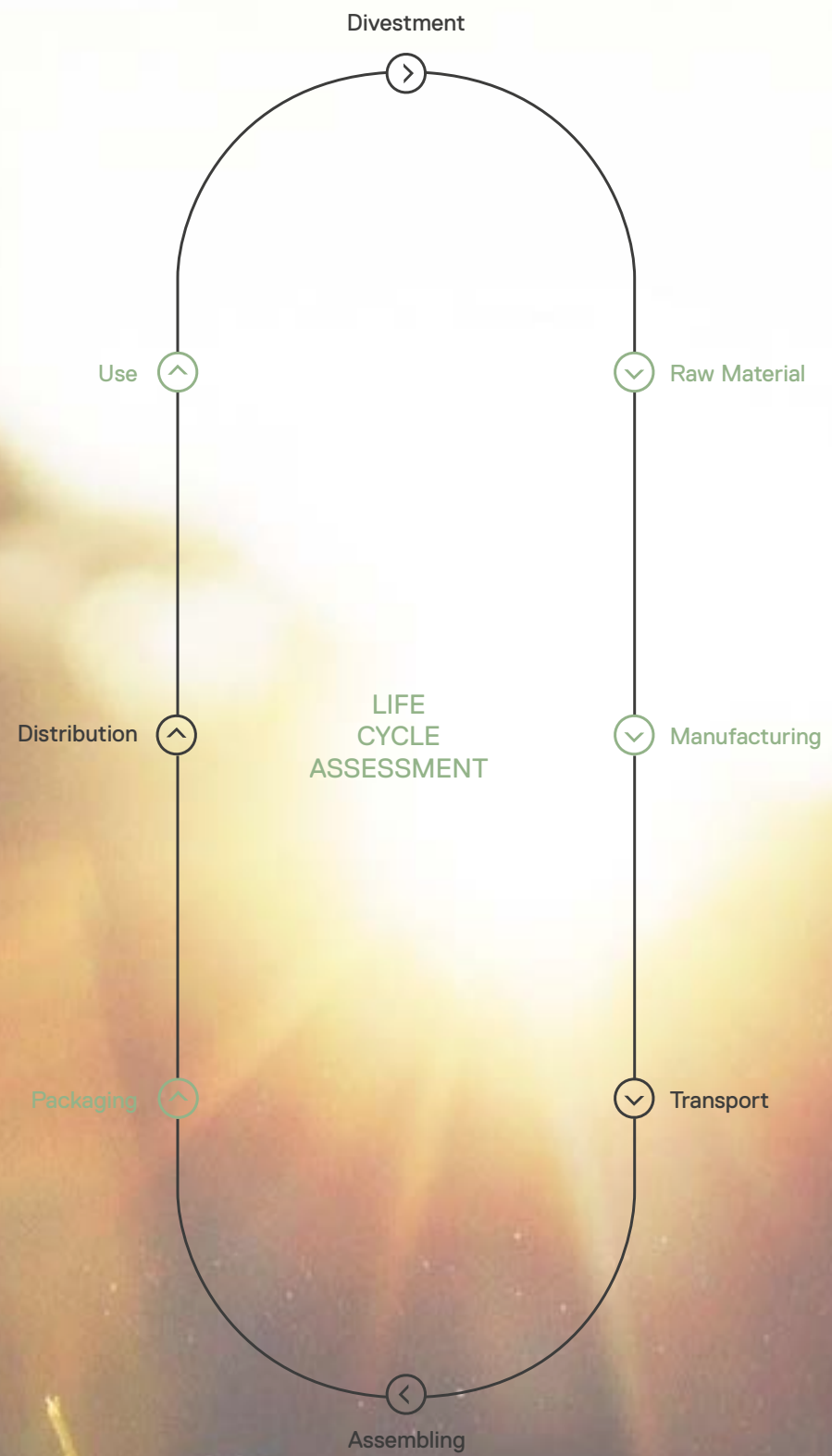

→ Light is energy as well as matter. The attention to the sources, materials, optical solutions and efficient management choice is the key to have a correct energy balance.

# Beyond spaces

↳ Transversal light solutions

Let's go beyond the classic separation between technical products and design products; let's open a new transversal point of view on the light project and its applications. We can offer all-purpose and surprising solutions, translating innovation and high-tech performance into emotional perception. And create products that are perfect for both outdoor and indoor, or products for the office space that have an exciting, fascinating design.



# Knowledge and manufacturing

The Artemide collections are a unique blend of values and competences: the company's approach to human and responsible light is combined with design and material savoir faire to create a mix of next-generation technology, industry 4.0 and ancient wisdoms – a perfect expression of sustainable design. Every Artemide product is completely developed in our Pregnana Milanese headquarter and made in Europe, to guarantee the best results of quality and conformity to international standards. Certified laboratories support research and every stage of the product development, from the preliminary study until the final release. The culture of the project, the true value of Italian design, is the unique coincidence of scientific, technical and humanistic heritage knowledge. Innovation, born from an interdisciplinary culture, is nourished by research and scientific thought, that is the ability to see things differently than before.

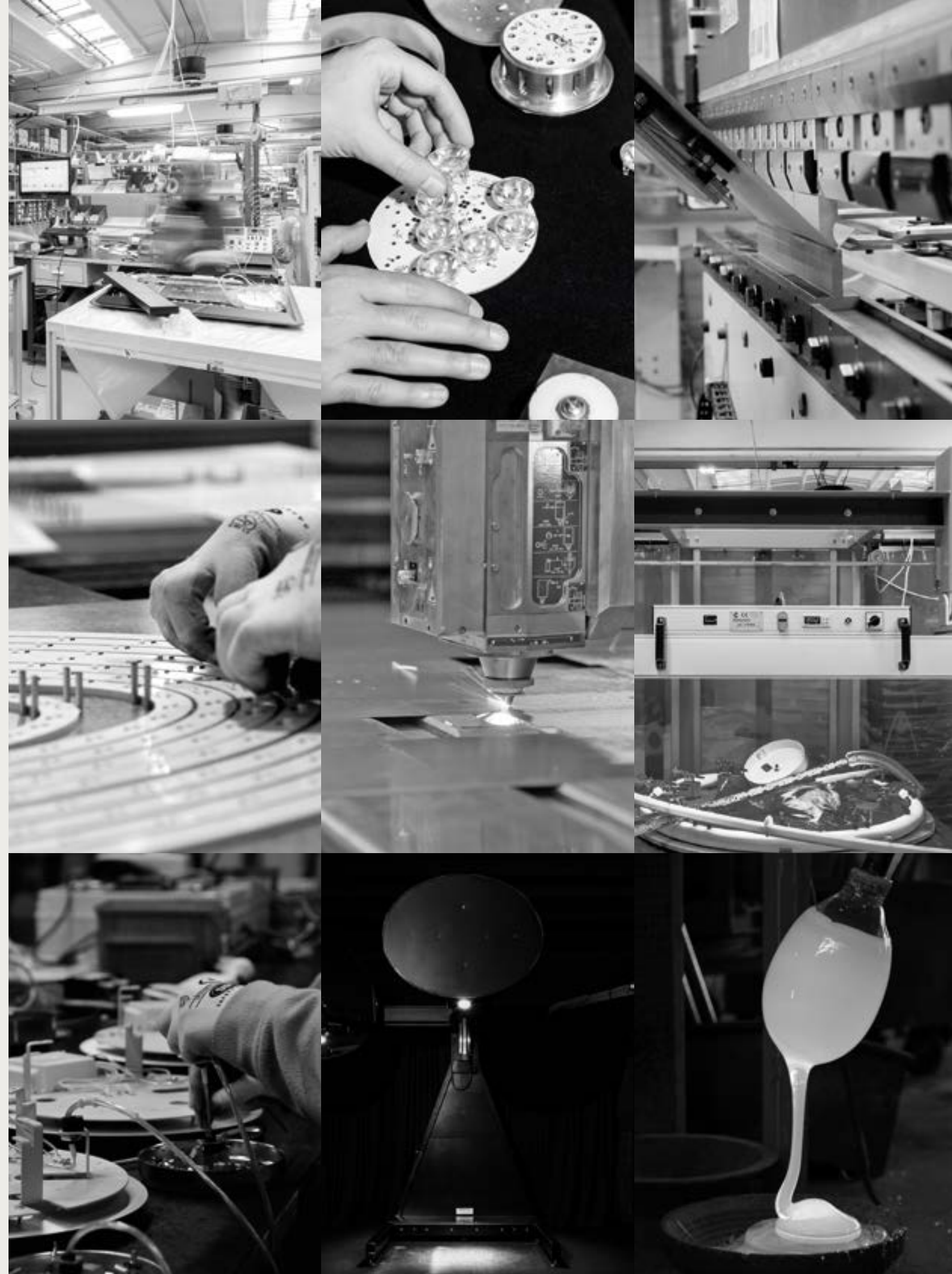

# Patents of invention

Artemide opens up important research issues connected with photonics and new technologies to outline a future vision, a new way to interpret and experience light. The time for technological transfer - from research to implementation - is gradually shrinking. All our patents of inventions are immediately applied to the catalogue's products.

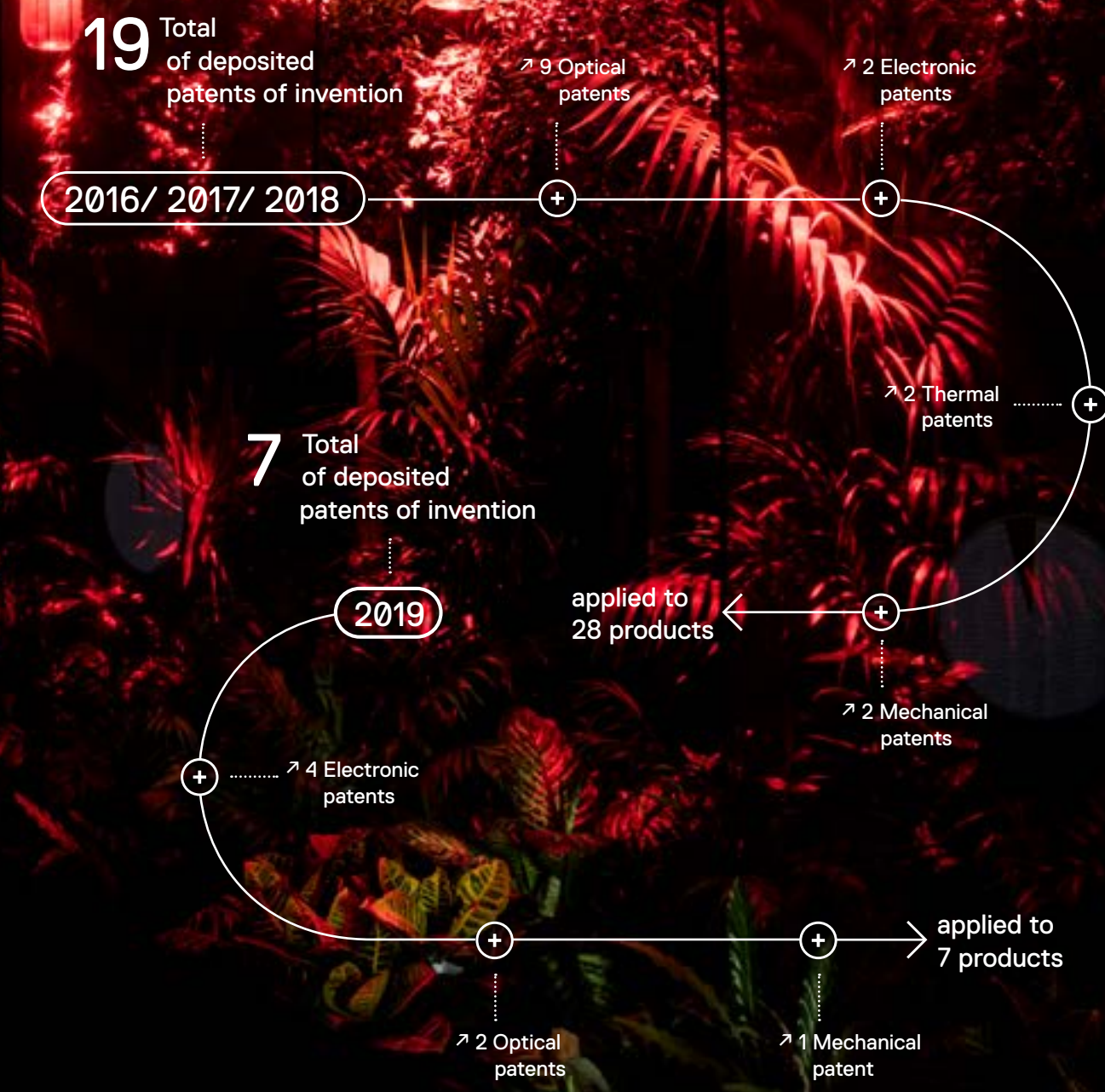
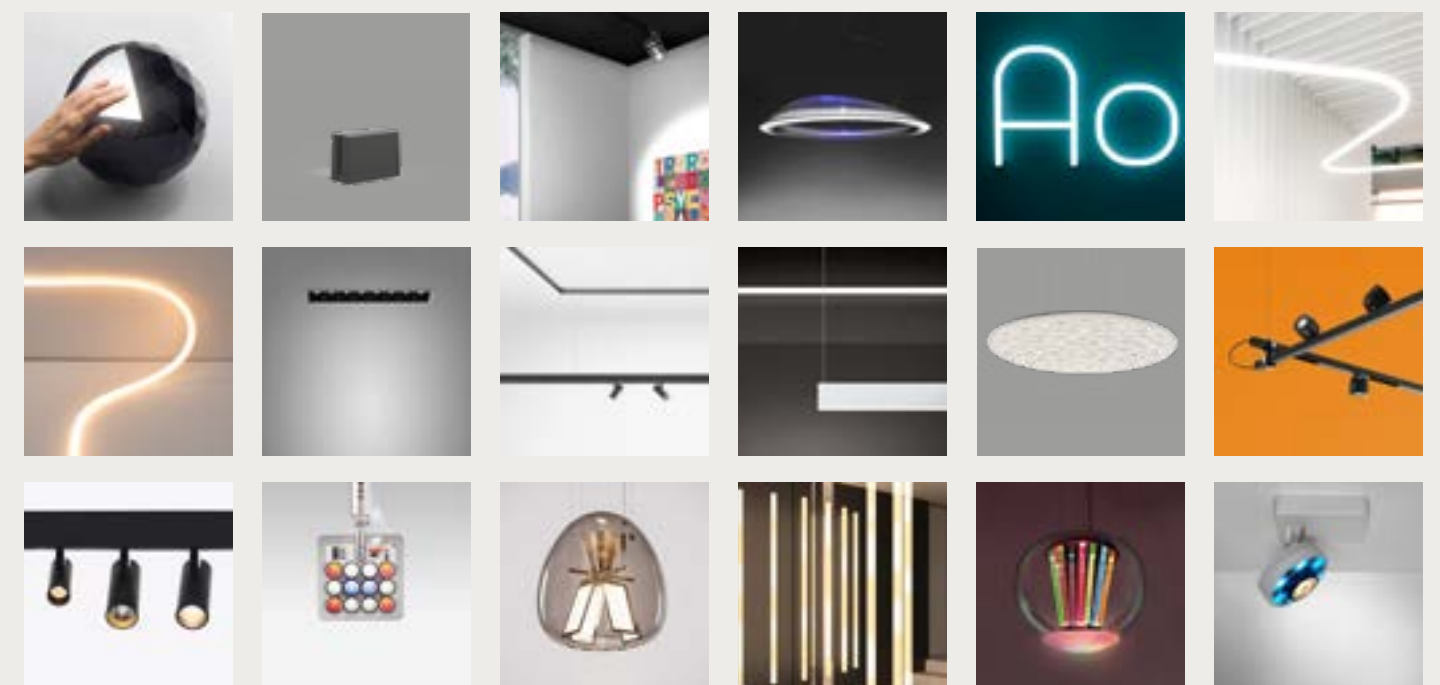

↑ Audi City Lab., Milan

↑ BIG Office, New York

# Bespoke products

↑ Atfimi by Heinz Beck



The world of project is our world. Project is our strong skill and we are always eager to work with new partners that can give us the opportunity to create special products. We can develop custom product solutions, both starting from existing versions and by designing and producing bespoke items. We have a dedicated custom department working together with the Research, Development and Innovation staff, to create new and different solutions and support them with services and intelligence.

↑ National Bank of Kuwait, Kuwait City



↑ Office, Milan



↑ La Porta, Malpensa



↑ San Siro, Milan



↑ Pietà Rondanini Museum, Milan



↑ Louvre, Abu Dhabi





# Smart environment

↳ We turn spaces into places

Light is a key medium in the relation between people and their space. It can provide new experiences and emotions requalifying our spaces and making us authors and protagonists of a social landscape. Light reinforces our sense of belonging by turning every space in the place we want it to be.



# Light has two identities

↳ Light is wavelength

Light is wavelength. It is an invisible physical phenomenon that makes the world visible. Good light can follow and sustain the rhythmic flow of the lives, behavior and emotions of individuals by introducing them to a broader dimension for a new perceptive experience. In its continuous relation between humanity and the environment, light is a material for the construction of space, delimiting territoriality and influencing our state of mind. Light has significant repercussions on the feeding of nature by helping its growth and favouring the photobiological processes that guarantee its survival.

↳ Light is quanta

Light is energy and it can also transmit data, information and intelligence sustaining man to interpret the space he lives in. Photonics is the science of the new millennium and it's remodeling the world as we know it. New technologies are developing at a tremendous speed, revolutionizing the design limits of light.

# We design interactivity to generate interactions

## Freedom

People are different, and so is their approach with light. That's why we offer different solutions to manage this relationship: from the physical analogic interaction to the digital one made of sensors and apps, ours is a very simple principle: everyone must be free to determine his/her approach with light. We are constantly developing new generations of products that express a parametric human-centered vision, in order to achieve a dynamic and positive experience.

→ **Artemide App**

→ **Geo LI-FI**



# Artemide APP

Artemide designs products and services to allow a more advanced and flexible use thereof.

The Artemide App is a user-friendly and intuitive interface that can be used as a daily tool for private use and as well as a project variable for workplace and retail, public and urban spaces. Man is the centre of the project, the orchestra director of his light concerto.

All Artemide products can be Artemide App compatible.

- Managing up to 500 lighting fixtures, single or in groups
- Connecting with Bluetooth Low Energy
- Distance: bluetooth Android 25-30 m, Apple 15 m
- Cloud backup
- Secured personal access
- Multi-user: 1 administrator, more guests
- Multidevices control for the same network
- For tablet and smartphone
- Bluetooth interface for DALI products - 40 addresses
- 10 Static scenarios
- 15 Dynamic scenarios
- Scheduling
- News channel



## → Interactive Experience

### Emissions

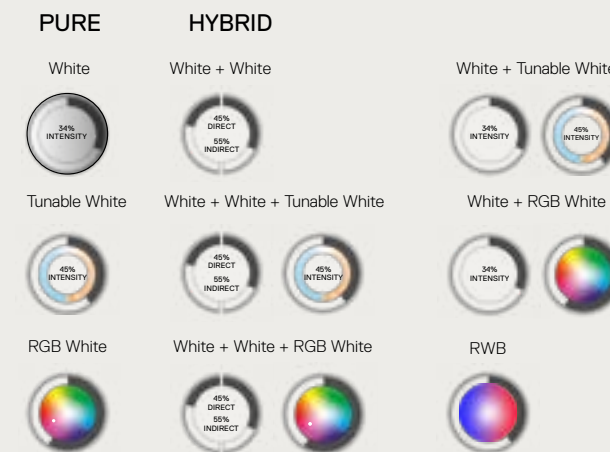

### Dynamic Scenes



Motion Sensor

Vocal Control  
Amazon Alexa  
Google Home

## → Parametric Experience

### Environmental Quality



### Heat map

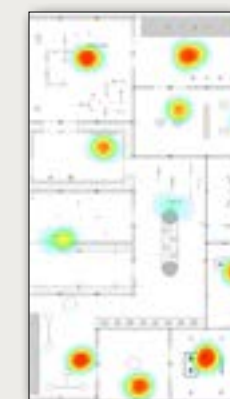

Daylight Sensor

Target Point

Circadian Rythm

# Geo Li-Fi

Artemide is able not only to design the right light for every space but also to propose innovative applications of the Geo Li-Fi technology introducing specific multi-level solutions for any application fields, generating unexpected experiences for engagement, interaction and inspiration.

Geo Li-Fi technology is not a product-specific standard solution but an open platform for the creation of new services. It's capable to be integrated into multiple products and systems within Artemide collections to combine the perfect lighting solution with an innovative interpretation of interaction.

The Geo Li-Fi App, especially designed by Artemide, processes and transforms the contents received through light into useful information, services, or interactions. It can also refer to external links, thus acting as a bridge towards more in-depth analyses that help us to interpret and understand spaces we live in. It is able to support a contextualized, real-time and tailored experience for the single user giving the possibility to select specific information, marketing and communication contents.

They can be related for example to what we are lighting or directions to drive visitors through spaces. Geo Li-Fi ensures much greater precision in tracking the position – within a few centimetres, rather than one metre. This allows very accurate and punctual localization of the position of the signal receiver.

The Geo Li-Fi technology can be used to provide information, as well as to collect data: it allows to create heat maps that recognize people in space, track their positions, record motion times and generate useful information on space use. It therefore works as a service for space users and as a tool for space operators.

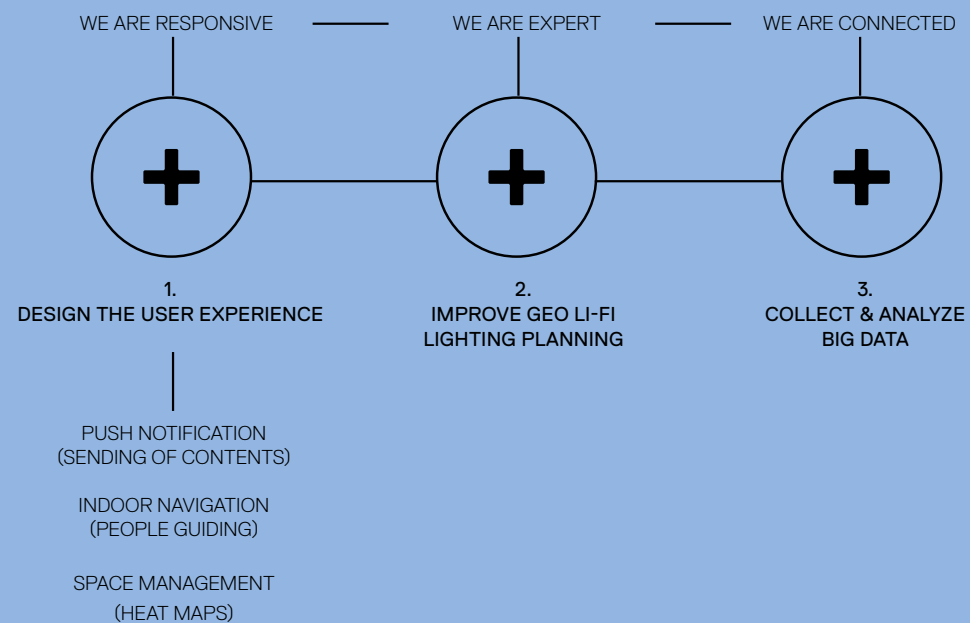

With Geo Li-Fi data is transmitted by the lamp through visible light, which is modulated according to the 0-1 binary signal, at the basis of all digital electronic communication. While the frequency of these light impulses cannot be perceived by the human eye, it generates a signal that the camera of any smart device can receive. Communication travels one way (from the lighting appliance to the device) and the bit rate is limited. The transmitted information should be quite "light" and therefore simple. It can be a static content, such as a message or an image, as well dynamic one, such as a video.

# Two configurators A.24 Alphabet of Light

Artemide provides tools to support the end customer and especially the lighting professionals in choosing the best lighting solution.

For an intuitive composition of the most complex systems, Artemide offers innovative and complete configurators on its website.

A24 and Alphabet of Light System Configurator are useful tools to simplify the design of your composition.

After defining the layout of the space, the desired system can be created by reconstructing it with a practical drag and drop of the various modules available.

Once the project is completed, the system returns a complete datasheet with all the details to proceed with the order.

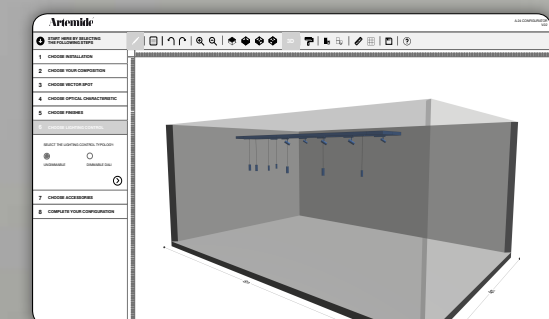
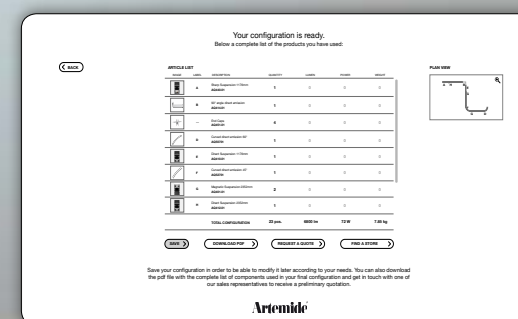
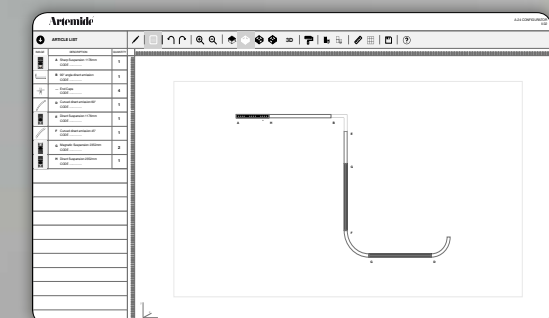
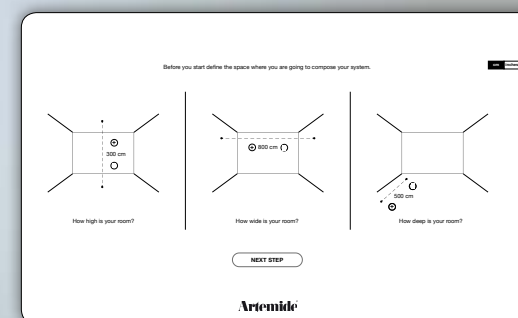



↪ Indoor

# Projector



Vector	_____	44
Picto	_____	82
LoT	_____	96
Cata	_____	112
Olmo	_____	128
Hoy	_____	136
Caelum	_____	158
Una Pro	_____	170
37 Cube	_____	182
Pad	_____	186
Track	_____	194







For further information on Vector  
↳ visit [artemide.com](http://artemide.com)

# Vector

Carlotta de Bevilacqua  
↳ 2017





# Vector colors



→ Fast delivery



→ Delivery time on demand



# Vector color temperatures



→ Fast delivery



→ Delivery time on demand





Artemide  
App  
↪ on request

## Magnetic track

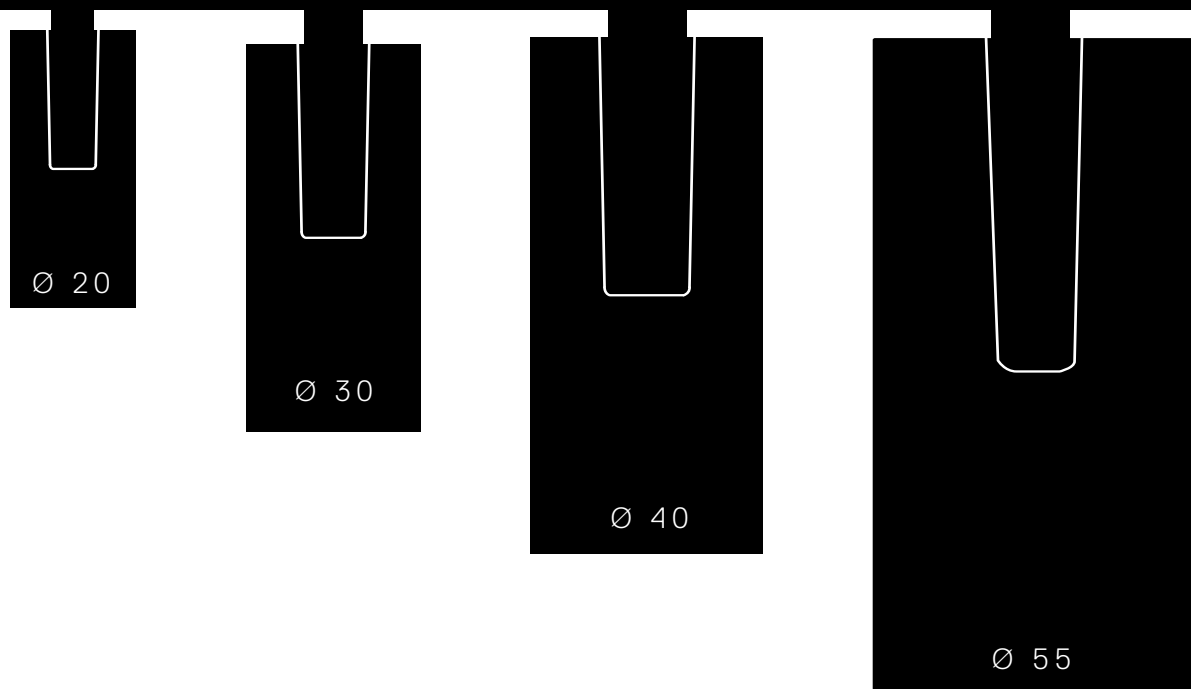

## 3-phaseTrack

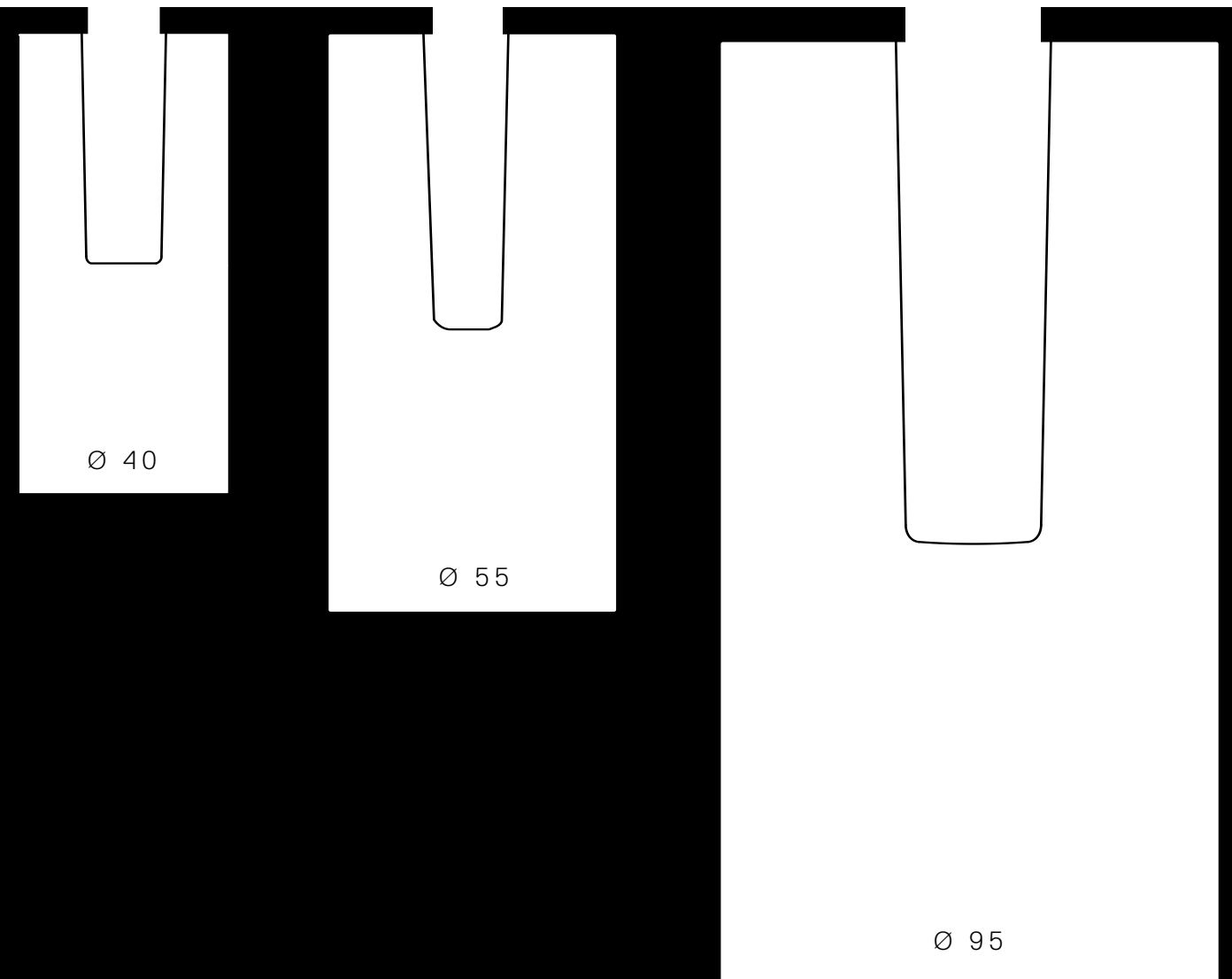

# Vector dimensions

# Vector is balanced

THE JUNCTION ARM IS INTEGRATED WITH THE SPOTLIGHT BODY.  
THE CENTER OF BALANCE IS PERFECTLY ALIGNED WITH THE TRACK.  
THE PIVOTING OF THE BODY AND THE ARM ORIENTATION ARE LOCKABLE.

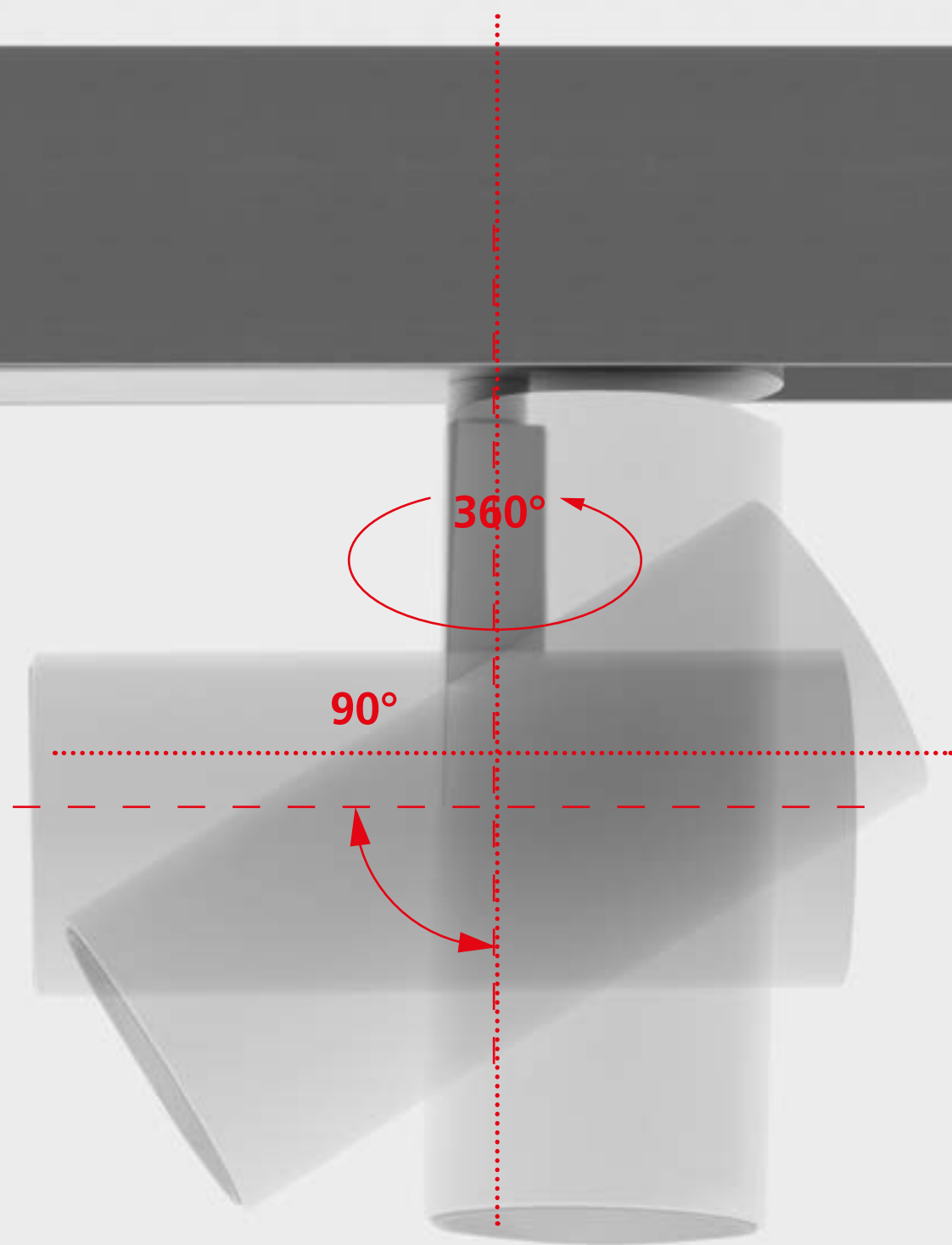



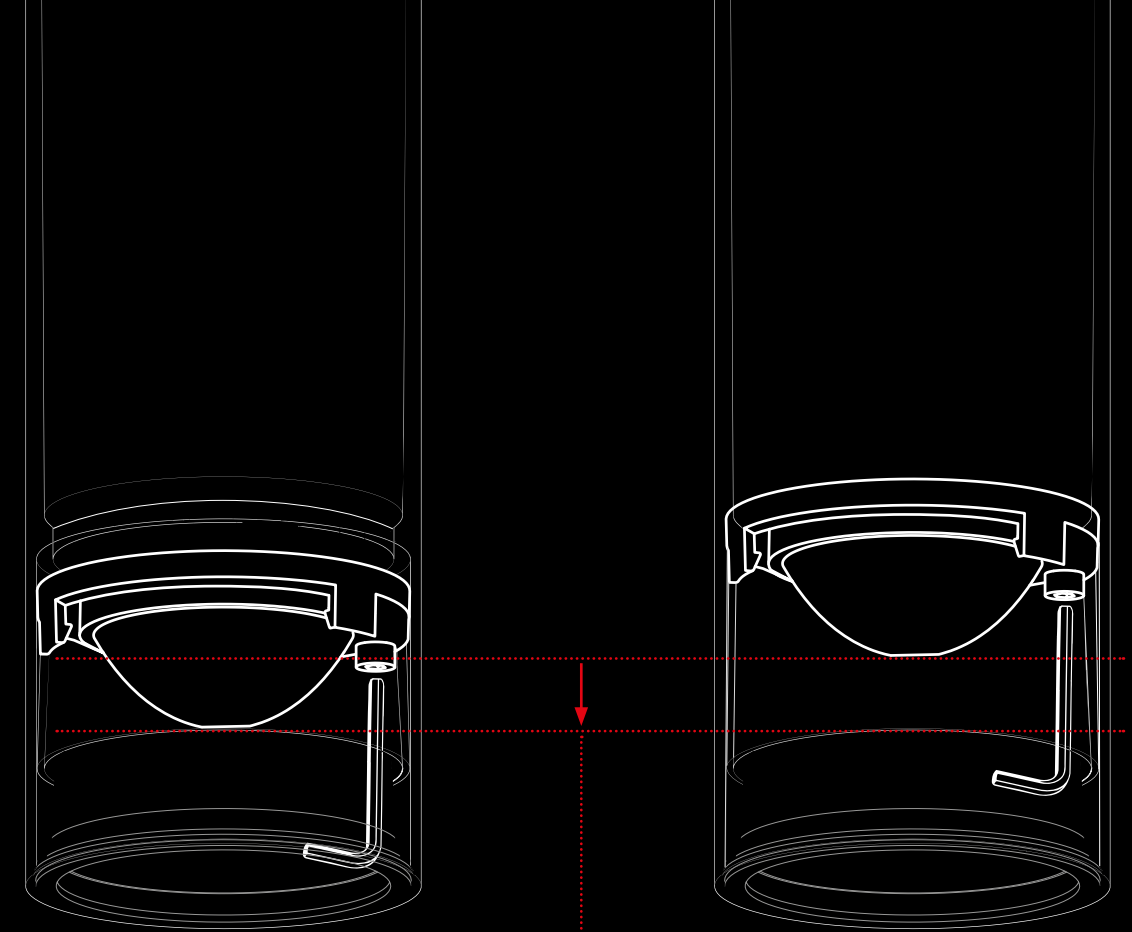

**Flood**  
**22°**  
**660 lm**

**Wide Flood**  
**32°**  
**1137 lm**

# Vector 55 zoom



ANTI-DAZZLE LOUVRE

# Vector 40 / 55 multiple accessories



ACCESSORIES HOLDER



LENS FOR ELLIPTICAL EMISSION  
SOFT FILTER



ADJUSTABLE DOWSERS

POSSIBILITY TO INSTALL UP TO 3 ACCESSORIES

# Vector typologies

## 3-PHASE TRACK



VECTOR 40

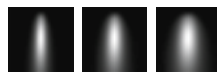

S 13° F 20° WF 28°  
10W 10W 10W  
540 lm 584 lm 528 lm



VECTOR 55

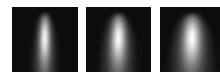

S 16° F 22° WF 32°  
25W 25W 25W  
1492 lm 1465 lm 1596 lm



VECTOR 55 ZOOM



F 22°- WF 32°  
23W  
660 - 1137 lm



VECTOR 95

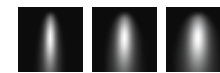

S 16° F 24° WF 60°  
31W 31W 31W  
2870 lm 2880 lm 2870 lm

## SEMI-RECESSED



VECTOR 40

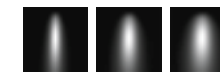

S 13° F 20° WF 28°  
8W 8W 8W  
540 lm 584 lm 528 lm



VECTOR 55

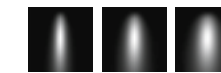

S 16° F 22° WF 32°  
21W 21W 21W  
1492 lm 1465 lm 1596 lm

## RECESSED



VECTOR 40

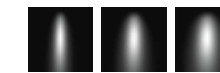

S 13° F 20° WF 28°  
8W 8W 8W  
540 lm 584 lm 528 lm



VECTOR 55

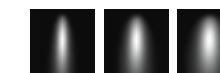

S 16° F 22° WF 32°  
17,5W 17,5W 17,5W  
1248 lm 1225 lm 1356 lm

## MAGNETIC TRACK



VECTOR 20

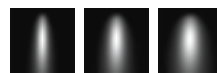

S 10° F 24° WF 32°  
2W 2W 2W  
175 lm 160 lm 140 lm



VECTOR 30

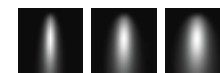

S 6° F 24° WF 40°  
6W 6W 6W  
475 lm 450 lm 425 lm



VECTOR 40

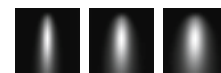

S 13° F 20° WF 28°  
10W 10W 10W  
540 lm 584 lm 528 lm



VECTOR 55

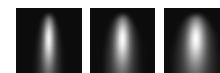

S 16° F 22° WF 32°  
26W 26W 26W  
1492 lm 1465 lm 1596 lm

## MAGNETIC TRACK PENDANT



VECTOR 40 PENDANT

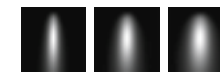

S 13° F 20° WF 28°  
10W 10W 10W  
540 lm 584 lm 528 lm



VECTOR 55 PENDANT

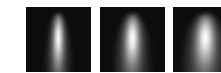

S 16° F 22° WF 32°  
26W 26W 26W  
1492 lm 1465 lm 1596 lm



VECTOR 55 ZOOM



F 22°- WF 32°  
23W  
660 - 1137 lm

# Vector

↪ 3-phase track



VECTOR 40



VECTOR 55



VECTOR 95

## ↪ VECTOR 3-PHASE TRACK

White Black  
 01 04  
 Fast delivery

Brushed Silver Brushed Copper Brushed Bronze  
 15 18 20  
 Delivery time on demand

S F WF

Delivery time on demand  
 2700K / 4000K

MacAdam 3SDCM  
 \*MacAdam 2SDCM  
 CRI = 90

IP20  
 90°  
 360°

### VECTOR 40 3-PHASE TRACK

Track slim adapter				Undimmable		Dimmable DALI		
W	Beam	Flux	CCT	Code	Code	Code	Code	
10 W	S 13°	540 lm	2700K	<b>AN011.</b> 01/04	<b>AN016.</b> 01/04			
			3000K	15/18/20	15/18/20			
			4000K	15/18/20	15/18/20			
		*F 20°	584 lm	2700K	<b>AN012.</b> 01/04	<b>AN017.</b> 01/04		
				3000K	15/18/20	15/18/20		
				4000K	15/18/20	15/18/20		
	*WF 28°	528 lm	2700K	<b>AN013.</b> 01/04	<b>AN018.</b> 01/04			
			3000K	15/18/20	15/18/20			
			4000K	15/18/20	15/18/20			

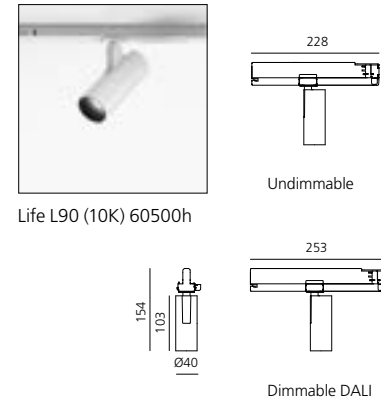

### VECTOR 55 TRACK 230V

Track slim adapter				Undimmable		Dimmable DALI		
W	Beam	Flux	CCT	Code	Code	Code	Code	
25 W	S 16°	1492 lm	2700K	<b>AN111.</b> 01/04	<b>AN116.</b> 01/04			
			3000K	15/18/20	15/18/20			
			4000K	15/18/20	15/18/20			
		F 22°	1465 lm	2700K	<b>AN112.</b> 01/04	<b>AN117.</b> 01/04		
				3000K	15/18/20	15/18/20		
				4000K	15/18/20	15/18/20		
	WF 32°	1596 lm	2700K	<b>AN113.</b> 01/04	<b>AN118.</b> 01/04			
			3000K	15/18/20	15/18/20			
			4000K	15/18/20	15/18/20			

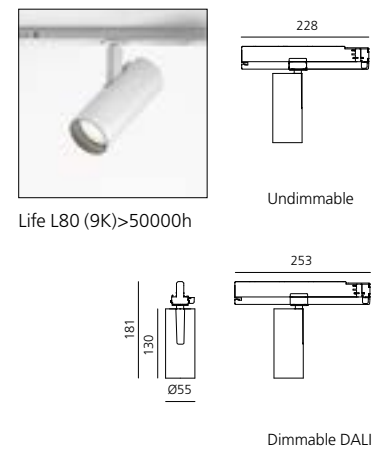

## ↪ VECTOR 3-PHASE TRACK

White Black  
 01 04  
 Fast delivery

Brushed Silver Brushed Copper Brushed Bronze  
 15 18 20  
 Delivery time on demand

S F WF

Delivery time on demand  
 2700K / 4000K

MacAdam 3SDCM  
 CRI = 90

IP20  
 90°  
 360°

### VECTOR 55 ZOOM TRACK 230V

Track slim adapter				Dimmable DALI	
W	Beam	Flux	CCT	Code	Code
23 W	F 22°-WF 32°	660 - 1137 lm	2700K	<b>AN119.</b> 01/04	
			3000K	15/18/20	<b>AN109.</b> 01/04
			4000K	15/18/20	<b>AN159.</b> 01/04
				15/18/20	
				15/18/20	
				15/18/20	

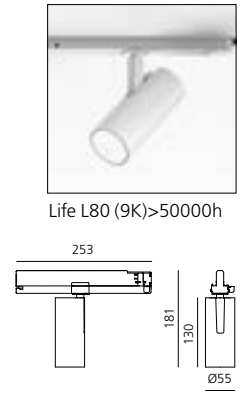

### VECTOR 95 TRACK 230V

Track slim adapter				Undimmable		Dimmable DALI		Dimmable DALI Eutrac	
W	Beam	Flux	CCT	Code	Code	Code	Code	Code	Code
31 W	S 16°	2870 lm	2700K	<b>AN211.</b> 01/04	<b>AN216.</b> 01/04	<b>AN316.</b> 01/04			
			3000K	15/18/20	15/18/20	15/18/20			
			4000K	15/18/20	15/18/20	15/18/20			
		F 24°	2880 lm	2700K	<b>AN201.</b> 01/04	<b>AN206.</b> 01/04	<b>AN306.</b> 01/04		
				3000K	15/18/20	15/18/20	15/18/20		
				4000K	15/18/20	15/18/20	15/18/20		
	WF 60°	2870 lm	2700K	<b>AN212.</b> 01/04	<b>AN217.</b> 01/04	<b>AN317.</b> 01/04			
			3000K	15/18/20	15/18/20	15/18/20			
			4000K	15/18/20	15/18/20	15/18/20			

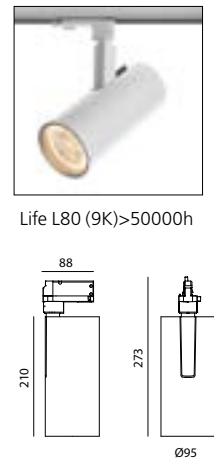

Accessories	Color	Vector 40 Code	Vector 55 Code	Vector 95 Code
Accessories holder		<b>AP90100</b>	<b>AP91100</b>	<b>AP92100</b>
Lens for elliptical emission		<b>AP90200</b>	<b>AP91200</b>	<b>M282007</b>
Soft filter		<b>AP90300</b>	<b>AP91300</b>	<b>M056807</b>
Anti-dazzle louvre		<b>AP90400</b>	<b>AP91400</b>	<b>M282100</b>
Adjustable dowsers	●		<b>AP91500</b>	<b>M059910</b>

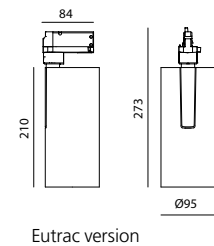

# Vector

## ↳ Recessed



### ↳ VECTOR RECESSED

White 01 Fast delivery	Black 04	Brushed Silver 15 Delivery time on demand	Brushed Copper 18	Brushed Bronze 20	S	F	WF	Driver 700/500mA SELV supplied separately. Fitting to be completed with trimless recessed structure.	MacAdam 3SDCM *MacAdam 2SDCM CRI = 90	IP20 90° 360°
------------------------------	-------------	---	----------------------	----------------------	---	---	----	--	---	---------------------

#### VECTOR 40 RECESSED

W	Beam	Flux	CCT	Code	
8 W	S 13°	540 lm	2700K	AP521. 01/04 15/18/20	
			3000K	AP501. 01/04 15/18/20	
			4000K	AP551. 01/04 15/18/20	
		*F 20°	584 lm	2700K	AP522. 01/04 15/18/20
				3000K	AP502. 01/04 15/18/20
				4000K	AP552. 01/04 15/18/20
	*WF 28°	528 lm	2700K	AP523. 01/04 15/18/20	
			3000K	AP503. 01/04 15/18/20	
			4000K	AP553. 01/04 15/18/20	

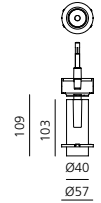
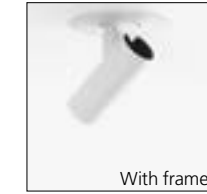
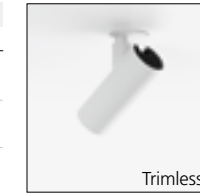

Life L90 (10K) 60500h

#### VECTOR 55 RECESSED

W	Beam	Flux	CCT	Code	
17,5 W	S 16°	1248 lm	2700K	AP531. 01/04 15/18/20	
			3000K	AP511. 01/04 15/18/20	
			4000K	AP561. 01/04 15/18/20	
		F 22°	1225 lm	2700K	AP532. 01/04 15/18/20
				3000K	AP512. 01/04 15/18/20
				4000K	AP562. 01/04 15/18/20
	WF 32°	1356 lm	2700K	AP533. 01/04 15/18/20	
			3000K	AP513. 01/04 15/18/20	
			4000K	AP563. 01/04 15/18/20	

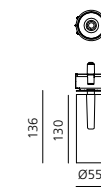
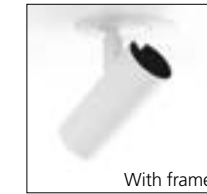
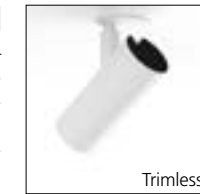

Life L80 (9K)>50000h

	Vector 40	Vector 55
Code	AP50000	AP50000
Trimless recessed structure		
Optional trim frame Ø 108	AP590. 01/04	AP591. 01/04

	Driver	Vac	L <sub>mm</sub>	W <sub>mm</sub>	H <sub>mm</sub>		Code
Vector 40	15-32W 700mA*	220-240	146,5	43,5	22	☐	Undimmable DV1030
Vector 55	15-32W 500mA	220-240	146,5	43,5	22	☐	Undimmable DV1030
Vector 40	11-25W 700mA	220-240	164	38	24,5	☐	Dimmable DALI DV1031
Vector 55	11-25 W 500mA	220-240	164	38	24,5	☐	Dimmable DALI DV1031

\* 1 Driver for Max 3 Spots

# Vector

## ↳ Semi-recessed



### ↳ VECTOR SEMI-RECESSED

White <b>01</b> Fast delivery	Black <b>04</b>	Brushed Silver <b>15</b>	Brushed Copper <b>18</b>	Brushed Bronze <b>20</b> Delivery time on demand	S	F	WF	Driver supplied separately. Vector 40: 700mA Vector 55: 600mA	MacAdam 3SDCM *MacAdam 2SDCM CRI = 90	IP20 90° 360°
-------------------------------------	--------------------	-----------------------------	-----------------------------	--	---	---	----	---	---	---------------------

#### VECTOR 40 SEMI-RECESSED

W	CRI	Beam	Flux	CCT	Code		
8 W	90	S 13°	540 lm	2700K	<b>AP621.</b> 01/04 15/18/20		
				3000K	<b>AP601.</b> 01/04 15/18/20		
				4000K	<b>AP651.</b> 01/04 15/18/20		
				*F 20°	584 lm	2700K	<b>AP622.</b> 01/04 15/18/20
				3000K	<b>AP602.</b> 01/04 15/18/20		
				4000K	<b>AP652.</b> 01/04 15/18/20		
		*WF 28°	528 lm	2700K	<b>AP623.</b> 01/04 15/18/20		
					3000K	<b>AP603.</b> 01/04 15/18/20	
					4000K	<b>AP653.</b> 01/04 15/18/20	



Life L90 (10K) 60500h

#### VECTOR 55 SEMI-RECESSED

W	CRI	Beam	Flux	CCT	Code		
21W	90	S 16°	1492 lm	2700K	<b>AP631.</b> 01/04 15/18/20		
				3000K	<b>AP611.</b> 01/04 15/18/20		
				4000K	<b>AP661.</b> 01/04 15/18/20		
				F 22°	1465 lm	2700K	<b>AP632.</b> 01/04 15/18/20
				3000K	<b>AP612.</b> 01/04 15/18/20		
				4000K	<b>AP662.</b> 01/04 15/18/20		
		WF 32°	1596 lm	2700K	<b>AP633.</b> 01/04 15/18/20		
					3000K	<b>AP613.</b> 01/04 15/18/20	
					4000K	<b>AP663.</b> 01/04 15/18/20	

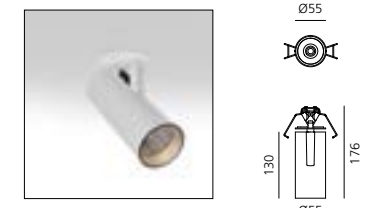

Life L80 (9K)>50000h

	Driver	Vac	L <sub>mm</sub>	W <sub>mm</sub>	H <sub>mm</sub>		Code
Vector 40	15-32W 700mA*	220-240	146,5	43,5	22	☐	Undimmable <b>DV1030</b>
Vector 55	15-32W 600mA	220-240	146,5	43,5	22	☐	Undimmable <b>DV1030</b>
Vector 40	11-25 W 700mA	220-240	164	38	24,5	☐	Dimmable DALI <b>DV1031</b>
Vector 55	11-25 W 600mA	220-240	164	38	24,5	☐	Dimmable DALI <b>DV1031</b>

\* 1 Driver for Max 3 Spots





Vector  
↪ Magnetic track

## ↪ VECTOR MAGNETIC TRACK

White Black  
 01 04  
 Fast delivery

Brushed Silver Brushed Copper Brushed Bronze  
 15 18 20  
 Delivery time on demand

S F WF

Delivery time on demand  
 2700K / 4000K

MacAdam 3SDCM  
 CRI = 80

IP20  
  
 90°  
 360°

### VECTOR 20 MAGNETIC

W	Beam	Flux	CCT	Dimmable DALI Code
2 W	S 10°	175 lm	2700K	AP711. 01/04 15/18/20
			3000K	AP701. 01/04 15/18/20
			4000K	AP751. 01/04 15/18/20
F 24°	160 lm	2700K	AP712. 01/04 15/18/20	
		3000K	AP702. 01/04 15/18/20	
		4000K	AP752. 01/04 15/18/20	
WF 32°	140 lm	2700K	AP713. 01/04 15/18/20	
		3000K	AP703. 01/04 15/18/20	
		4000K	AP753. 01/04 15/18/20	

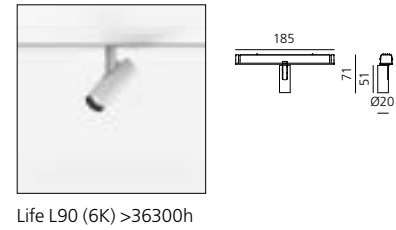

Life L90 (6K) >36300h

### VECTOR 30 MAGNETIC

W	Beam	Flux	CCT	Dimmable DALI Code
6 W	XS 6°	475 lm	2700K	AP811. 01/04 15/18/20
			3000K	AP801. 01/04 15/18/20
			4000K	AP851. 01/04 15/18/20
F 24°	450 lm	2700K	AP812. 01/04 15/18/20	
		3000K	AP802. 01/04 15/18/20	
		4000K	AP852. 01/04 15/18/20	
WF 40°	425 lm	2700K	AP813. 01/04 15/18/20	
		3000K	AP803. 01/04 15/18/20	
		4000K	AP853. 01/04 15/18/20	

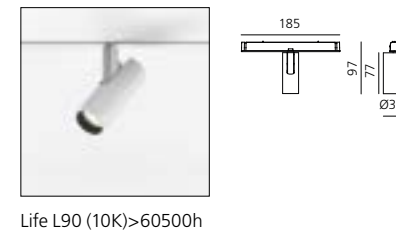

Life L90 (10K) >60500h

## ↪ VECTOR MAGNETIC TRACK

White Black  
 01 04  
 Fast delivery

Brushed Silver Brushed Copper Brushed Bronze  
 15 18 20  
 Delivery time on demand

S F WF

Delivery time on demand  
 2700K / 4000K

MacAdam 3SDCM  
 \*MacAdam 2SDCM  
 CRI = 90

IP20  
  
 90°  
 360°

### VECTOR 40 MAGNETIC

W	Beam	Flux	CCT	Dimmable DALI Code
10 W	S 13°	540 lm	2700K	AP011. 01/04 15/18/20
			3000K	AP001. 01/04 15/18/20
			4000K	AP051. 01/04 15/18/20
*F 20°	584 lm	2700K	AP012. 01/04 15/18/20	
		3000K	AP002. 01/04 15/18/20	
		4000K	AP052. 01/04 15/18/20	
*WF 28°	528 lm	2700K	AP013. 01/04 15/18/20	
		3000K	AP003. 01/04 15/18/20	
		4000K	AP053. 01/04 15/18/20	

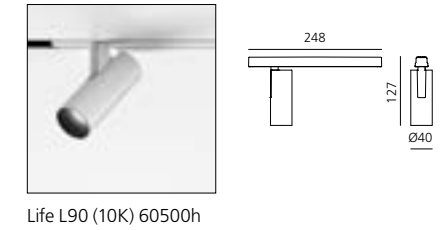

Life L90 (10K) 60500h

### VECTOR 55 MAGNETIC

W	Beam	Flux	CCT	Dimmable DALI Code
26 W	S 16°	1492 lm	2700K	AP111. 01/04 15/18/20
			3000K	AP101. 01/04 15/18/20
			4000K	AP151. 01/04 15/18/20
F 22°	1465 lm	2700K	AP112. 01/04 15/18/20	
		3000K	AP102. 01/04 15/18/20	
		4000K	AP152. 01/04 15/18/20	
WF 32°	1596 lm	2700K	AP113. 01/04 15/18/20	
		3000K	AP103. 01/04 15/18/20	
		4000K	AP153. 01/04 15/18/20	

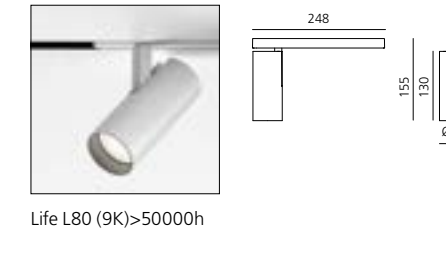

Life L80 (9K) >50000h

Accessoires	Color	Vector 40 Code	Vector 55 Code
Accessories holder		AP90100	AP91100
Lens for elliptical emission		AP90200	AP91200
Soft filter		AP90300	AP91300
Anti-dazzle louvre		AP90400	AP91400
Adjustable dowsers	●		AP91500

## ↳ VECTOR MAGNETIC TRACK

White	Black	Brushed Silver	Brushed Copper	Brushed Bronze	S	F	WF	Delivery time on demand 2700K / 4000K	MacAdam 3SDCM CRI = 90	IP20 90° 360°
01	04	15	18	20						
Fast delivery		Delivery time on demand								

### VECTOR 55 ZOOM MAGNETIC

W	Beam	Flux	CCT	Dimmable DALI Code
23 W	F 22°-WF 32°	660 - 1137 lm	2700K	<b>AP114.</b> 01/04 15/18/20
			3000K	<b>AP104.</b> 01/04 15/18/20
			4000K	<b>AP154.</b> 01/04 15/18/20

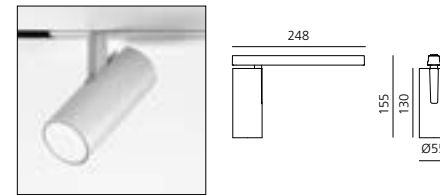

Life L80 (9K)>50000h

### VECTOR 40 PENDANT MAGNETIC

W	Beam	Flux	CCT	Dimmable DALI Code
10 W	S 13°	540 lm	2700K	<b>AP211.</b> 01/04 15/18/20
			3000K	<b>AP201.</b> 01/04 15/18/20
			4000K	<b>AP251.</b> 01/04 15/18/20
	F 20°	584 lm	2700K	<b>AP212.</b> 01/04 15/18/20
			3000K	<b>AP202.</b> 01/04 15/18/20
			4000K	<b>AP252.</b> 01/04 15/18/20
	WF 28°	528 lm	2700K	<b>AP213.</b> 01/04 15/18/20
			3000K	<b>AP203.</b> 01/04 15/18/20
			4000K	<b>AP253.</b> 01/04 15/18/20

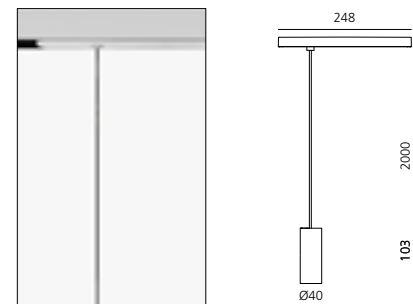

Life L90 (10K) 60500h

### VECTOR 55 PENDANT MAGNETIC

W	Beam	Flux	CCT	Dimmable DALI Code
26 W	S 16°	1492 lm	2700K	<b>AP311.</b> 01/04 15/18/20
			3000K	<b>AP301.</b> 01/04 15/18/20
			4000K	<b>AP351.</b> 01/04 15/18/20
	F 22°	1465 lm	2700K	<b>AP312.</b> 01/04 15/18/20
			3000K	<b>AP302.</b> 01/04 15/18/20
			4000K	<b>AP352.</b> 01/04 15/18/20
	WF 32°	1596 lm	2700K	<b>AP313.</b> 01/04 15/18/20
			3000K	<b>AP303.</b> 01/04 15/18/20
			4000K	<b>AP353.</b> 01/04 15/18/20

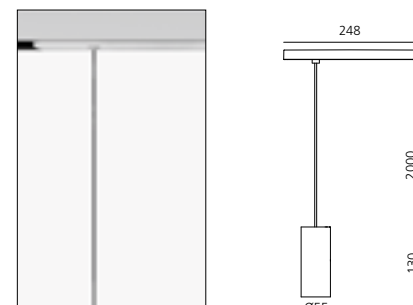

Life L80 (9K)>50000h





# Picto

Studio Artemide  
↔ 2013



Series of high-output LED adjustable projectors.  
2 colours available.

Optical units available in 3 sizes, depending on the  
light source: 70 mm, 100 mm, 125 mm.

Defined narrow beams in the LED version, thanks to  
the hybrid optical system (Picto 125).

Picto 125 High Flux uses a high-yield reflective optical  
unit.

The new Picto High Flux improves the performance  
thanks to the high installed power and its high  
efficiency.

Picto 125 Tuneable White (LED): colour temperature  
can be adjusted from 2,900K to 5,500K – CRI>91  
(min).

Adjustability: -90°/+90°, rotation up to 355°.

Precise aiming of the projectors, thanks to advanced  
locking system.

Wide range of accessories: UV filters, chromatic  
filters, louvres, asymmetric diffuser, adjustable  
dowsers, Gobo to project images or control shape of  
beam.

2 installation options: with 3-circuit track adapter  
(available for ceiling mounted option), or base plate  
for ceiling mounting.

Electronic power supply: with DALI dimmable, or non-  
dimmable options.

Materials: injection-moulded aluminium head,  
aluminium or polymer body, pure aluminium reflectors.

Compliant to EN60598-1 standard and other specific  
regulations.



For further information on Picto  
↪ visit [artemide.com](http://artemide.com)

# Picto colors



# Picto accessory

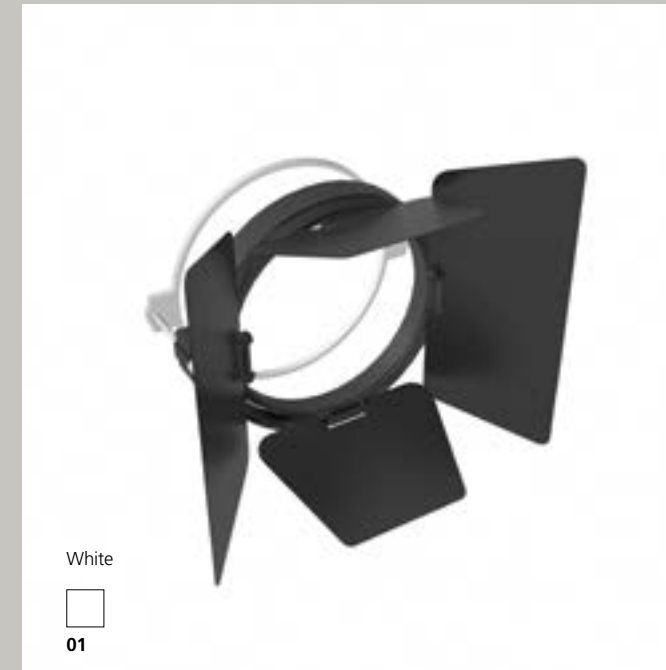



↳ PICTO 70

White Black S F WF XF 220/240Vac 50/60Hz MacAdam 2SDCM IP20  
 electronic ballast included. Life L80 (9K)>50000h CRI=90  
 850°  
 -90° 90° 355°

Vertical				
W	Weight	Beam	Flux	CCT
20 W	1,20 kg	S 14°	1095 lm	3000K
			1349 lm	4000K
		F 35°	1753 lm	3000K
			1806 lm	4000K
		WF 43°	1780 lm	3000K
			1834 lm	4000K
		XF 50°	1822 lm	3000K
			1877 lm	4000K

Undimmable	
Code	
AD017. 01/04	
AD018. 01/04	
AD011. 01/04	
AD014. 01/04	
AD012. 01/04	
AD015. 01/04	
AD013. 01/04	
AD016. 01/04	

DALI dimmable	
Code	
AD037. 01/04	
AD038. 01/04	
AD031. 01/04	
AD034. 01/04	
AD032. 01/04	
AD035. 01/04	
AD033. 01/04	
AD036. 01/04	



Vertical Eutrac				
W	Weight	Beam	Flux	CCT
20 W	1,20 kg	S 14°	1095 lm	3000K
			1349 lm	4000K
		F 35°	1753 lm	3000K
			1806 lm	4000K
		WF 43°	1780 lm	3000K
			1834 lm	4000K
		XF 50°	1822 lm	3000K
			1877 lm	4000K

Undimmable Eutrac	
Code	
AD007. 01/04	
AD008. 01/04	
AD001. 01/04	
AD004. 01/04	
AD002. 01/04	
AD005. 01/04	
AD003. 01/04	
AD006. 01/04	

DALI dimmable Eutrac	
Code	
AD027. 01/04	
AD028. 01/04	
AD021. 01/04	
AD024. 01/04	
AD022. 01/04	
AD025. 01/04	
AD023. 01/04	
AD026. 01/04	

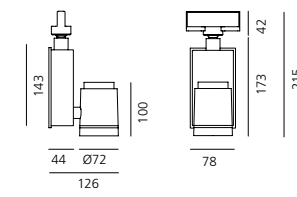

Horizontal				
W	Weight	Beam	Flux	CCT
20 W	1,20 kg	S 14°	1095 lm	3000K
			1349 lm	4000K
		F 35°	1753 lm	3000K
			1806 lm	4000K
		WF 43°	1780 lm	3000K
			1834 lm	4000K
		XF 50°	1822 lm	3000K
			1877 lm	4000K

Undimmable	
Code	
AD057. 01/04	
AD058. 01/04	
AD051. 01/04	
AD054. 01/04	
AD052. 01/04	
AD055. 01/04	
AD053. 01/04	
AD056. 01/04	

DALI dimmable	
Code	
AD077. 01/04	
AD078. 01/04	
AD071. 01/04	
AD074. 01/04	
AD072. 01/04	
AD075. 01/04	
AD073. 01/04	
AD076. 01/04	



Horizontal Eutrac				
W	Weight	Beam	Flux	CCT
20 W	1,20 kg	S 14°	1095 lm	3000K
			1349 lm	4000K
		F 35°	1753 lm	3000K
			1806 lm	4000K
		WF 43°	1780 lm	3000K
			1834 lm	4000K
		XF 50°	1822 lm	3000K
			1877 lm	4000K

Undimmable Eutrac	
Code	
AD047. 01/04	
AD048. 01/04	
AD041. 01/04	
AD044. 01/04	
AD042. 01/04	
AD045. 01/04	
AD043. 01/04	
AD046. 01/04	

DALI dimmable Eutrac	
Code	
AD067. 01/04	
AD068. 01/04	
AD061. 01/04	
AD064. 01/04	
AD062. 01/04	
AD065. 01/04	
AD063. 01/04	
AD066. 01/04	

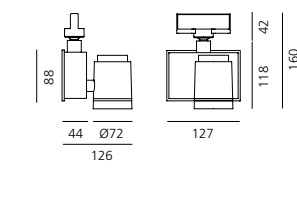

Accessories Picto 70

	Projector	Color	Code
	<input type="radio"/>	<input checked="" type="radio"/>	M083037
	<input checked="" type="radio"/>	<input type="radio"/>	M083017
	<input type="radio"/>	<input checked="" type="radio"/>	M082837
	<input checked="" type="radio"/>	<input type="radio"/>	M082817
	<input type="radio"/>	<input checked="" type="radio"/>	M083937
	<input checked="" type="radio"/>	<input type="radio"/>	M083917
	<input type="radio"/>	<input checked="" type="radio"/>	M083837
	<input checked="" type="radio"/>	<input type="radio"/>	M083817
	<input type="radio"/>	<input checked="" type="radio"/>	L176320
	<input checked="" type="radio"/>	<input type="radio"/>	L176330

↳ PICTO 100

White Black F WF XF 220/240Vac 50/60Hz MacAdam 2SDCM IP20  
 electronic ballast included. Life L80 (9K)>50000h CRI=90  
 850°  
 -90° 90° 355°

Vertical				
W	Weight	Beam	Flux	CCT
35 W	2,60 kg	F 28°	2843 lm	3000K
			2928 lm	4000K
		WF 42°	2808 lm	3000K
			2892 lm	4000K
		XF 63°	2836 lm	3000K
			2921 lm	4000K

Undimmable	
Code	
AD111. 01/04	
AD114. 01/04	
AD112. 01/04	
AD115. 01/04	
AD113. 01/04	
AD116. 01/04	

DALI dimmable	
Code	
AD131. 01/04	
AD134. 01/04	
AD132. 01/04	
AD135. 01/04	
AD133. 01/04	
AD136. 01/04	



Vertical Eutrac				
W	Weight	Beam	Flux	CCT
35 W	2,60 kg	F 28°	2843 lm	3000K
			2928 lm	4000K
		WF 42°	2808 lm	3000K
			2892 lm	4000K
		XF 63°	2836 lm	3000K
			2921 lm	4000K

Undimmable Eutrac	
Code	
AD101. 01/04	
AD104. 01/04	
AD102. 01/04	
AD105. 01/04	
AD103. 01/04	
AD106. 01/04	

DALI dimmable Eutrac	
Code	
AD121. 01/04	
AD124. 01/04	
AD122. 01/04	
AD125. 01/04	
AD123. 01/04	
AD126. 01/04	

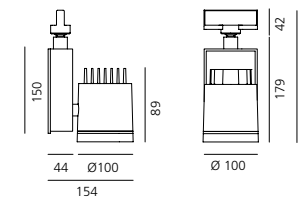

Horizontal				
W	Weight	Beam	Flux	CCT
35 W	2,60 kg	F 28°	2843 lm	3000K
			2928 lm	4000K
		WF 42°	2808 lm	3000K
			2892 lm	4000K
		XF 63°	2836 lm	3000K
			2921 lm	4000K

Undimmable	
Code	
AD151. 01/04	
AD154. 01/04	
AD152. 01/04	
AD155. 01/04	
AD153. 01/04	
AD156. 01/04	

DALI dimmable	
Code	
AD171. 01/04	
AD174. 01/04	
AD172. 01/04	
AD175. 01/04	
AD173. 01/04	
AD176. 01/04	



Horizontal Eutrac				
W	Weight	Beam	Flux	CCT
35 W	2,60 kg	F 28°	2843 lm	3000K
			2928 lm	4000K
		WF 42°	2808 lm	3000K
			2892 lm	4000K
		XF 63°	2836 lm	3000K
			2921 lm	4000K

Undimmable Eutrac	
Code	
AD141. 01/04	
AD144. 01/04	
AD142. 01/04	
AD145. 01/04	
AD143. 01/04	
AD146. 01/04	

DALI dimmable Eutrac	
Code	
AD161. 01/04	
AD164. 01/04	
AD162. 01/04	
AD165. 01/04	
AD163. 01/04	
AD166. 01/04	

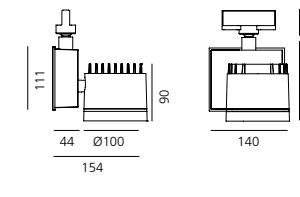

Accessories Picto 100

	Projector	Color	Code
	<input type="radio"/>	<input checked="" type="radio"/>	M082737
	<input checked="" type="radio"/>	<input type="radio"/>	M082717
	<input type="radio"/>	<input checked="" type="radio"/>	M082637
	<input checked="" type="radio"/>	<input type="radio"/>	M082617
	<input type="radio"/>	<input checked="" type="radio"/>	M081737
	<input checked="" type="radio"/>	<input type="radio"/>	M081717
			M080545
	<input type="radio"/>	<input checked="" type="radio"/>	L176320
	<input checked="" type="radio"/>	<input type="radio"/>	L176330



↳ PICTO 125

White Black S F WF 220/240Vac 50/60Hz MacAdam 2SDCM IP20  
 electronic ballast included. Life L80 (9K)>50000h CRI=90  
 850°  
 -90° 90° 355°

Picto 125 High Flux					Undimmable		DALI dimmable	
W	Weight	Beam	Flux	CCT	Code	Code	Code	Code
68 W	2,60 kg	F 17°	5371 lm	3000K	AD211. 01/04	AD231. 01/04	AD231. 01/04	AD231. 01/04
			5532 lm	4000K	AD213. 01/04	AD233. 01/04	AD233. 01/04	
		WF 41°	5253 lm	3000K	AD212. 01/04	AD232. 01/04	AD232. 01/04	AD232. 01/04
			5411 lm	4000K	AD214. 01/04	AD234. 01/04	AD234. 01/04	AD234. 01/04



Picto 125 High Flux Eutrac					Undimmable Eutrac		DALI dimmable Eutrac	
W	Weight	Beam	Flux	CCT	Code	Code	Code	Code
68 W	2,60 kg	F 17°	5371 lm	3000K	AD201. 01/04	AD221. 01/04	AD221. 01/04	AD221. 01/04
			5532 lm	4000K	AD203. 01/04	AD223. 01/04	AD223. 01/04	AD223. 01/04
		WF 41°	5253 lm	3000K	AD202. 01/04	AD222. 01/04	AD222. 01/04	AD222. 01/04
			5411 lm	4000K	AD204. 01/04	AD224. 01/04	AD224. 01/04	AD224. 01/04

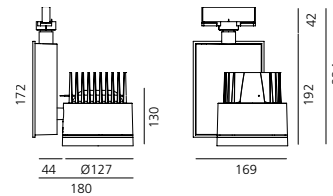

Picto 125					Undimmable		DALI dimmable	
W	Weight	Beam	Flux	CCT	Code	Code	Code	Code
46 W	2,60 kg	F 17°	3972 lm	3000K	AD311. 01/04	AD331. 01/04	AD331. 01/04	AD331. 01/04
			4091 lm	4000K	AD313. 01/04	AD333. 01/04	AD333. 01/04	AD333. 01/04
		WF 41°	3976 lm	3000K	AD312. 01/04	AD332. 01/04	AD332. 01/04	AD332. 01/04
			4095 lm	4000K	AD314. 01/04	AD334. 01/04	AD334. 01/04	AD334. 01/04

Picto 125 Eutrac					Undimmable Eutrac		DALI dimmable Eutrac	
W	Weight	Beam	Flux	CCT	Code	Code	Code	Code
46 W	2,60 kg	F 17°	3972 lm	3000K	AD301. 01/04	AD321. 01/04	AD321. 01/04	AD321. 01/04
			4091 lm	4000K	AD303. 01/04	AD323. 01/04	AD323. 01/04	AD323. 01/04
		WF 41°	3976 lm	3000K	AD302. 01/04	AD322. 01/04	AD322. 01/04	AD322. 01/04
			4095 lm	4000K	AD304. 01/04	AD324. 01/04	AD324. 01/04	AD324. 01/04

Accessories			Projector	Color	Code
	Accessory-holder + asymmetric diffuser (black)	<input type="radio"/>	<input checked="" type="radio"/>	<input checked="" type="radio"/>	M083137 M083117
	Accessory-holder + adjustable dowsers (black)	<input type="radio"/>	<input checked="" type="radio"/>	<input checked="" type="radio"/>	M082937 M082917
	Accessory-holder + anti-dazzle louvre	<input type="radio"/>	<input checked="" type="radio"/>	<input type="radio"/>	M083337 M083317
	Accessory-holder + IR filter	<input type="radio"/>	<input checked="" type="radio"/>	<input type="radio"/>	M083537 M083517
	Accessory-holder + lens for elliptical emission	<input type="radio"/>	<input checked="" type="radio"/>	<input type="radio"/>	M083437 M083417

			Projector	Color	Code
	Accessory-holder + chromatic filter Warmtone	<input type="radio"/>	<input checked="" type="radio"/>	<input checked="" type="radio"/>	M083637 M083617
	Accessory-holder + chromatic filter Coldtone	<input type="radio"/>	<input checked="" type="radio"/>	<input type="radio"/>	M083737 M083717
	UV Filter	<input type="radio"/>	<input type="radio"/>	<input type="radio"/>	M080535
	Accessory for ceiling installation	<input type="radio"/>	<input checked="" type="radio"/>	<input type="radio"/>	L176320 L176330

↳ PICTO 125 TUNABLE WHITE

White Black S WF 220/240Vac 50/60Hz MacAdam 2SDCM IP20  
 electronic ballast included. Life L80 (9K)>50000h CRI=93  
 850°  
 -90° 90° 355°

Picto 125 TW					Manual adjustment		DALI 8 dimmable	
W	Weight	Beam	Flux	CCT	Code	Code	Code	Code
32 W	2,60 kg	S 18°	1233 lm	2900K-5500K	AD411. 01/04	AD431. 01/04	AD431. 01/04	AD431. 01/04
			1157 lm	2900K-5500K	AD412. 01/04	AD432. 01/04	AD432. 01/04	AD432. 01/04
		WF 37°	1157 lm	2900K-5500K	AD412. 01/04	AD432. 01/04	AD432. 01/04	AD432. 01/04



Picto 125 TW Eutrac					*Manual adjustment		DALI 8 dimmable	
W	Weight	Beam	Flux	CCT	Code	Code	Code	Code
32 W	2,60 kg	S 18°	1233 lm	2900K-5500K	AD401. 01/04	AD421. 01/04	AD421. 01/04	AD421. 01/04
			1157 lm	2900K-5500K	AD402. 01/04	AD422. 01/04	AD422. 01/04	AD422. 01/04
		WF 37°	1157 lm	2900K-5500K	AD402. 01/04	AD422. 01/04	AD422. 01/04	AD422. 01/04

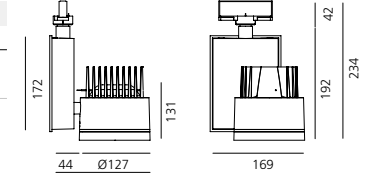

**TW**<sup>®</sup>  
Artemide Tunable White

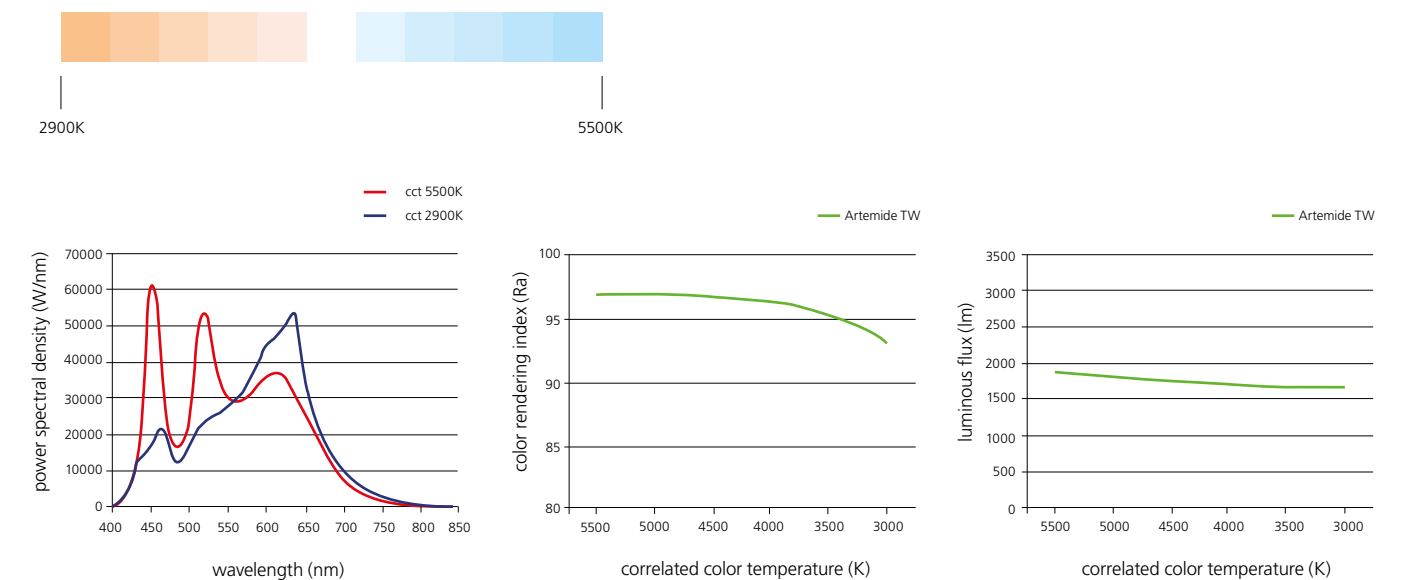

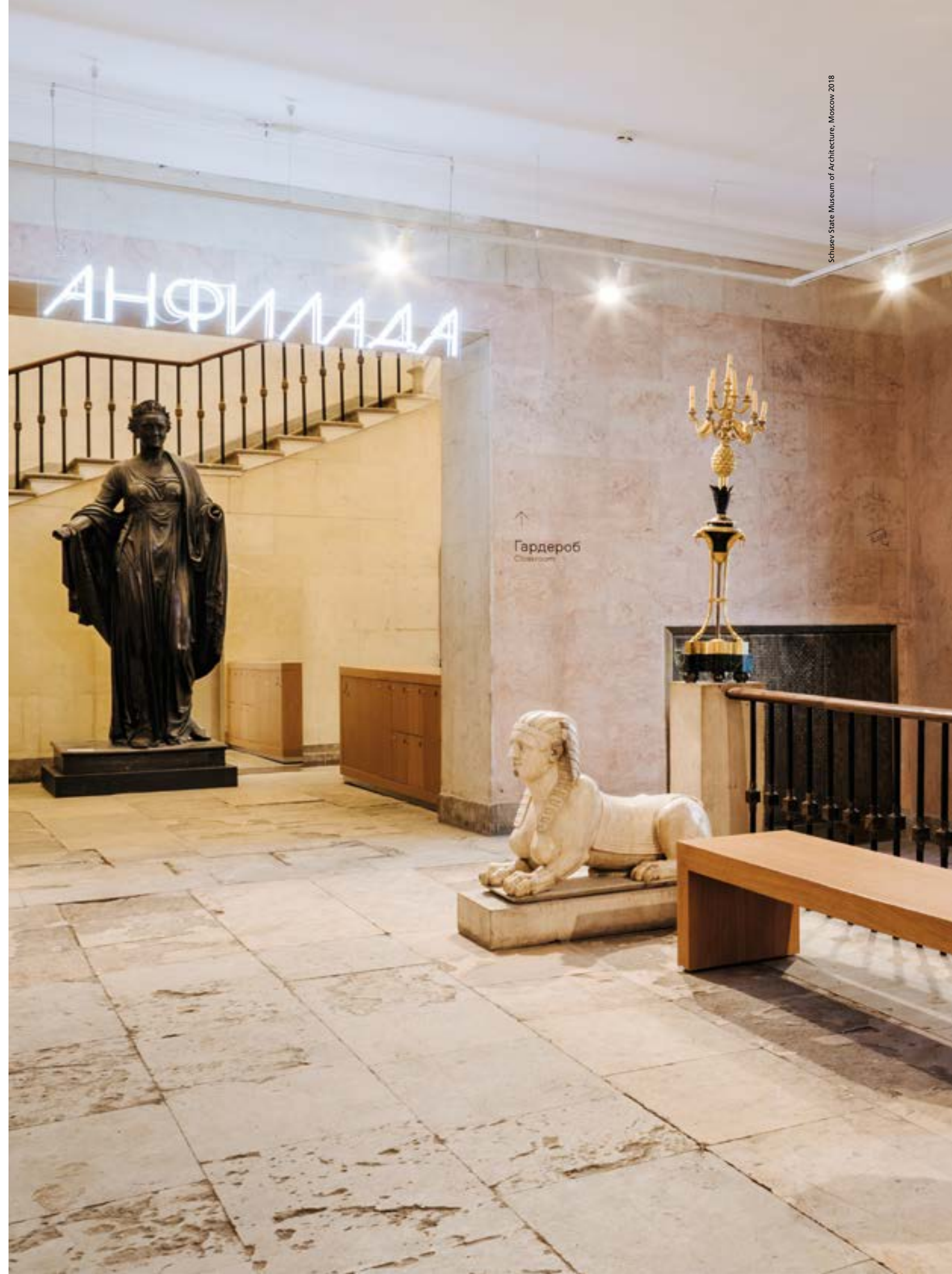
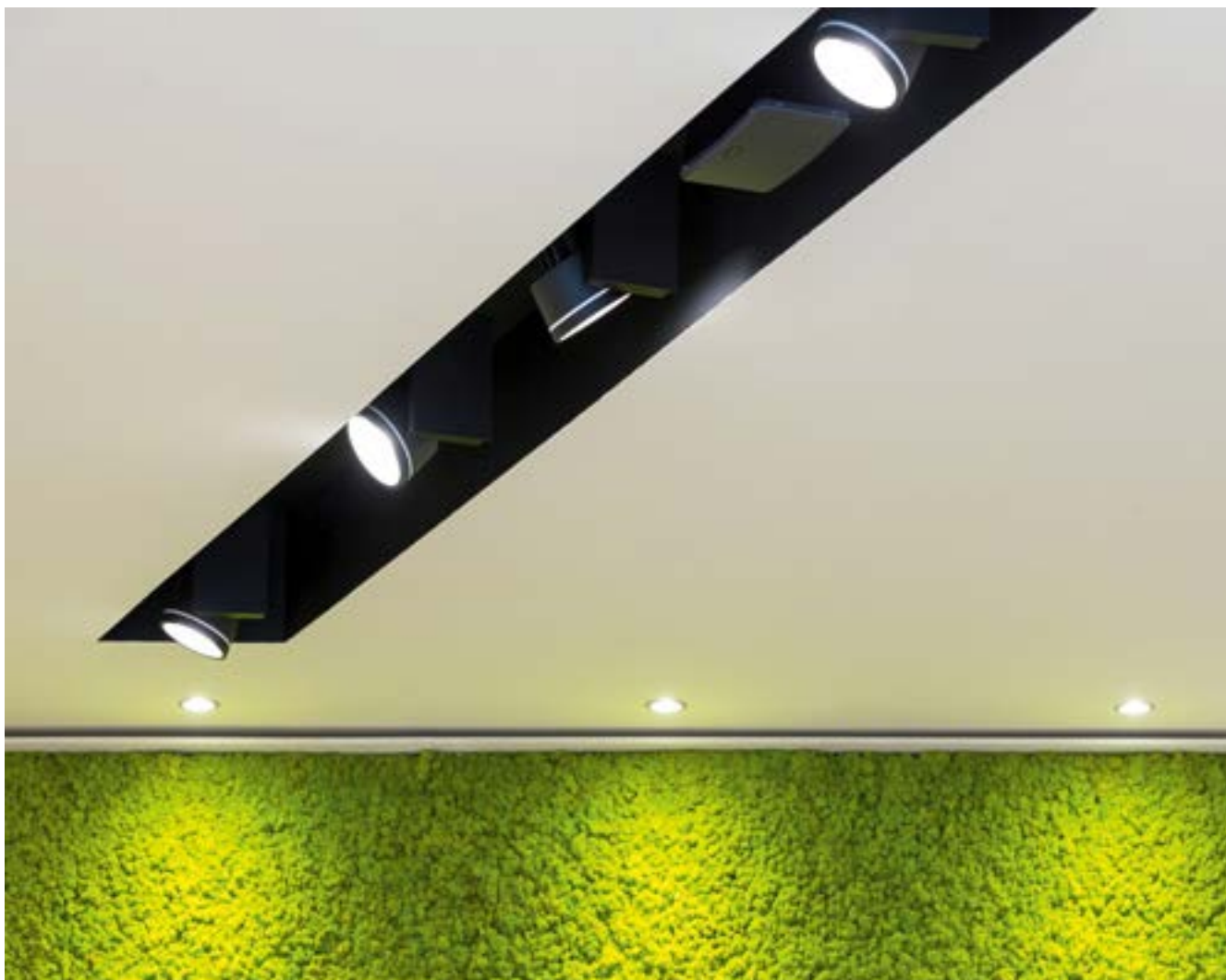

# LoT

Tapio Rosenius  
↪ 2016

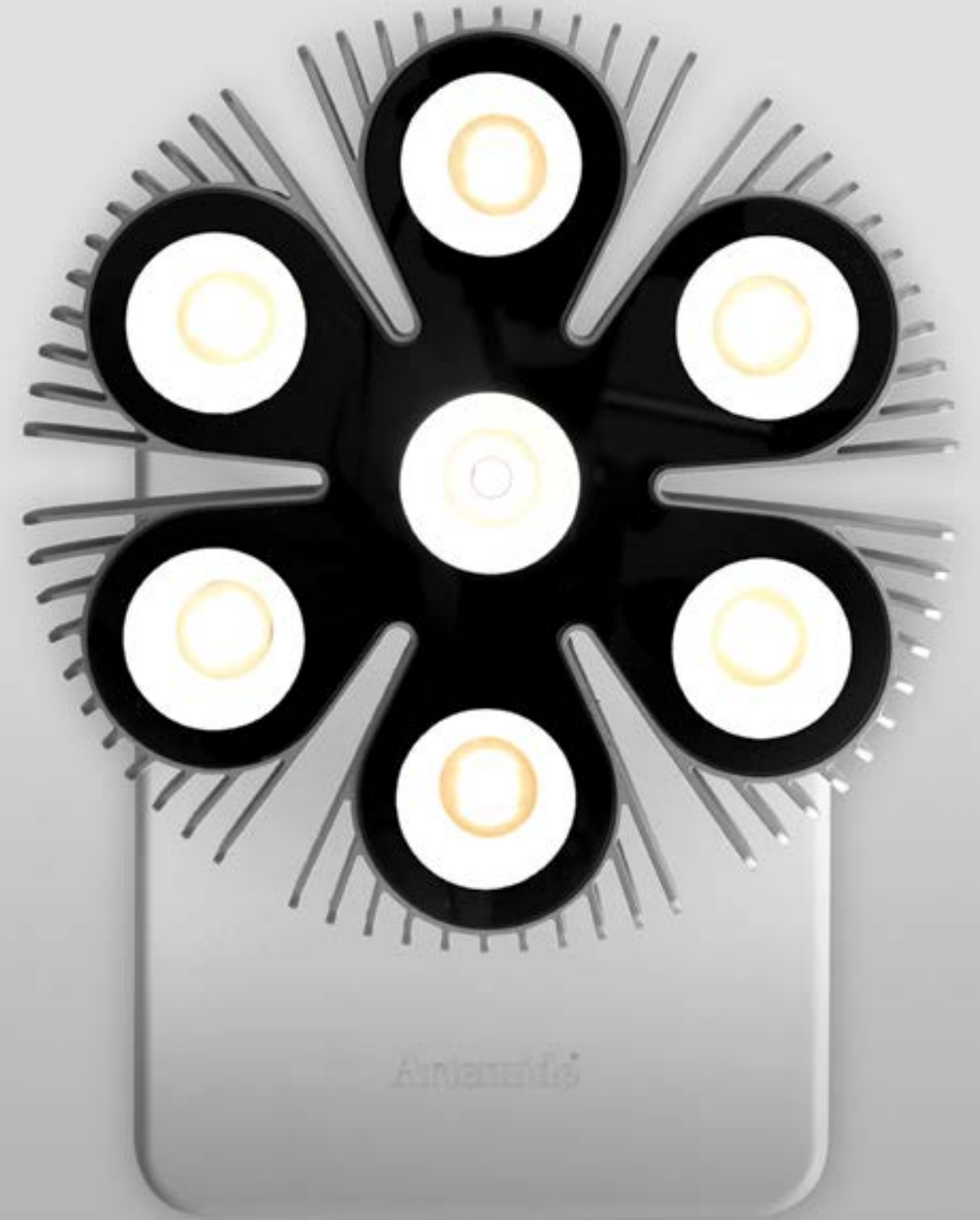

→ Patent of invention



# LoT

## ↪ RGB white

LoT is a universal projector that changes the beam angles of emissions and flows dynamically, and produces coloured ambient light.

It is a multi-focal projector that ensures utmost flexibility with minimal dimensions.

Its dynamic luminous beam does not imply any mechanical movements, but is rather the result of innovative optoelectronic design. Seven lenses define four base beam angles and, when combined, can modulate countless beam angles and intensities through current change.

A well-calibrated mix of currents allows to adjust the beam angles of the emissions and to manage all intermediate angles with a very high resolution. Fluid and gradual changes are thus perceived through the management of a single DMX channel. 1 DMX channel is dedicated to adjusting the light intensity.

In addition to the white light projector function, LoT can produce coloured ambient light in the RGBW mode through 4 additional dedicated channels.

Uses TIR lenses.

The special heat sink allows to adjust the lighting power to ensure excellent illumination up to a 5 m distance.

Specifications and details can be obtained from the Artemide sales office.



For further information on LoT  
↪ visit [artemide.com](http://artemide.com)



# LoT DMX

The LoT is an DMX RDM enabled device. DMX stands for Digital Multiplex. It is simply a standard system of controlling lighting equipment and accessories.

The Remote Device Management or RDM is a protocol enhancement to USITT DMX512 and enables the bi-directional communication between a lighting controller and the connected RDM devices over a standard DMX line, for simple, convenient commissioning. The protocol allows the configuration (setting of the start address, patching, load personalities), status monitoring, firmware update and management of these devices.

The wiring infrastructure for DMX has been precisely defined and all installers must follow these rules. Pls refer to the Artemide DMX Brochure for detailed information.

The LoT fixtures can be controlled with Standard DMX controllers (not RDM enabled) as the DSC30 NL19030 or the DSC60 NL19081. The setup of the parameters has to be carried out with a RDM controller during or before the installation.

For smaller installations with small quantities, Artemide offers the possibility for a pre-setup (addressing,...) of the DMX RDM fixtures.

Artemide offers the on-site support for the RDM setup and the programming of the system. Refer to the technical department of Artemide SpA for further information or assistance.

## CONFIGURATION FOR UP TO 32 LoT

At the beginning of every DMX line there must be a single DMX controller / transmitter.

This can have a max. of 32 standard devices connected over a max. cable length of 300m in a multi-drop bus topology commonly called a "daisy chain".

The last DMX512 Output needs to be terminated with a 120 ohms resistor joining pins + and -.



## CONFIGURATION FOR HANDLING MORE THAN 32 LoT

If more devices are required then a DMX splitter should be used.

The output of a DMX splitter is considered a new DMX line, with the same rules applying.

At the end of each DMX line a terminator should be fitted.

DMX fixtures are linked by 'daisy-chaining' cables; Y-Splitters are not possible.

Pls. use RDM enabled DMX splitter for RDM light fixtures.

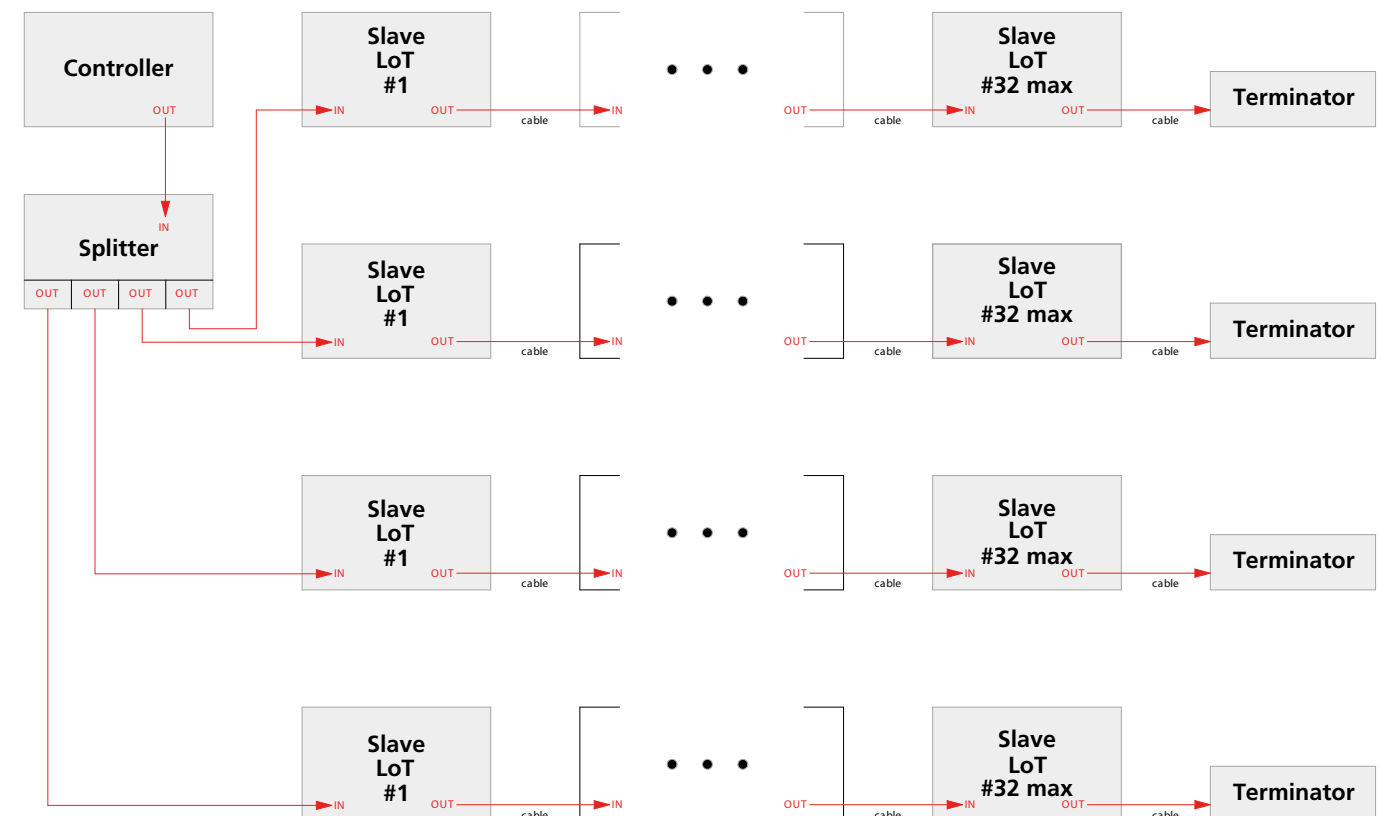

## DMX Channels

	CH 1 Beam	CH 2 Intensty	CH 3 Red	CH 4 Green	CH 5 Blue	CH 6 White	Flux	W	Beam
	0	255	0	0	0	0	1166 lm	22 W	5°
	50	255	0	0	0	0	2090 lm	36 W	11°
	100	255	0	0	0	0	2240 lm	37 W	28°
	150	255	0	0	0	0	3750 lm	57 W	34°
	175	255	0	0	0	0	3788 lm	55 W	38°
	200	255	0	0	0	0	3821 lm	56 W	42°
	225	255	0	0	0	0	3874 lm	58 W	43°
	255	255	0	0	0	0	1986 lm	33 W	50°
	0	0	255	0	0	0	225 lm	9 W	
	0	0	0	255	0	0	389 lm	11 W	
	0	0	0	0	255	0	64 lm	11 W	
	0	0	0	0	0	255	267 lm	11 W	

## ↪ LOT RGB WHITE

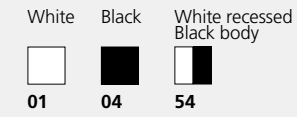

MacAdam 25DCM  
Life L70 (9K) 50000h  
CRI=90  
Control DMX/RDM  
DMX 6 footprint

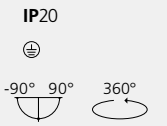

### TRACK

W	Weight	Flux	CCT	Code
max peak power 80 W	6,0 kg	1100 lm/	2700 K	<b>AA400.</b> 01/04
max continuous power 60 W		3800 lm		

To be used in combination with three-phase DALI tracks for DMX use.

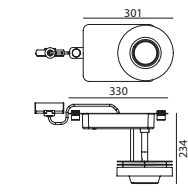

### RECESSED TRIM

W	Weight	Flux	CCT	Code
max peak power 80 W	6,0 kg	1100 lm/	2700 K	<b>AA200.</b> 01/04/54
max continuous power 55 W		3800 lm		



∅ 292

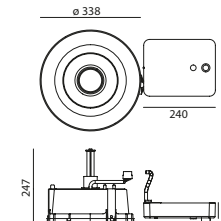

### RECESSED TRIMLESS

W	Weight	Flux	CCT	Code
max peak power 80 W	6,0 kg	1100 lm/	2700 K	<b>AA100.</b> 01/04/54
max continuous power 55 W		3800 lm		



∅ 292

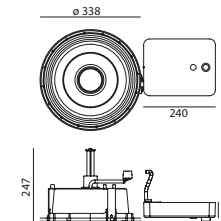

### CEILING

W	Weight	Flux	CCT	Code
max peak power 80 W	6,0 kg	1100 lm/	2700 K	<b>AA000.</b> 01/04
max continuous power 60 W		3800 lm		

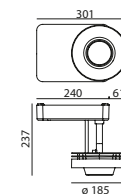

### SUSPENSION

W	Weight	Flux	CCT	Code
max peak power 80 W	6,0 kg	1100 lm/	2700 K	<b>AA300.</b> 01/04
max continuous power 60 W		3800 lm		

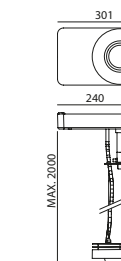

### SUSPENSION TRACK

W	Weight	Flux	CCT	Code
max peak power 80 W	6,0 kg	1100 lm/	2700 K	<b>AA500.</b> 01/04
max continuous power 60 W		3800 lm		

To be used in combination with three-phase DALI tracks for DMX use.

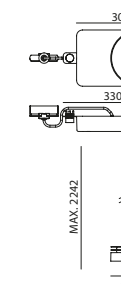



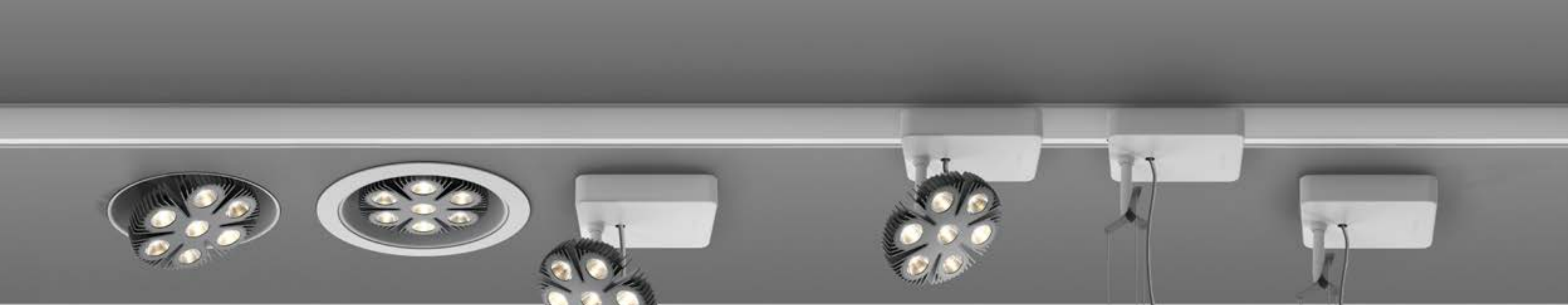

# LoT ↪ Reflector

LoT Reflector is a universal projector that changes the beam angles of emissions and flows dynamically. It is a multi-focal projector that ensures utmost flexibility with minimal dimensions.

Its dynamic luminous beam does not imply any mechanical movements, but is rather the result of innovative optoelectronic design. Seven lenses define 3 base beam angles and, when combined, can modulate countless beam angles and intensities through current change.

Each base beam angle has 3 different optical unit types: 3 for the narrow beam, 2 for the flood beam, and 2 for the extra flood beam.

A well-calibrated mix of currents on the 3 different channels allows to adjust the beam angles of the emissions and to manage all intermediate angles with a very high resolution. Fluid and gradual changes are thus perceived.

Footprint 1: white emission beam angle  
Footprint 2: white emission intensity

Uses reflective optical units.

The special heat sink allows to adjust the lighting power to ensure excellent illumination up to a 12 m installation height.

Specifications and details can be obtained from the Artemide sales office.



For further information on LoT  
↪ visit [artemide.com](http://artemide.com)





# LoT Reflector beam

S = Spot  
15°

F = Flood  
30°

WF = Wide flood  
45°

Max Power Spot  
20°

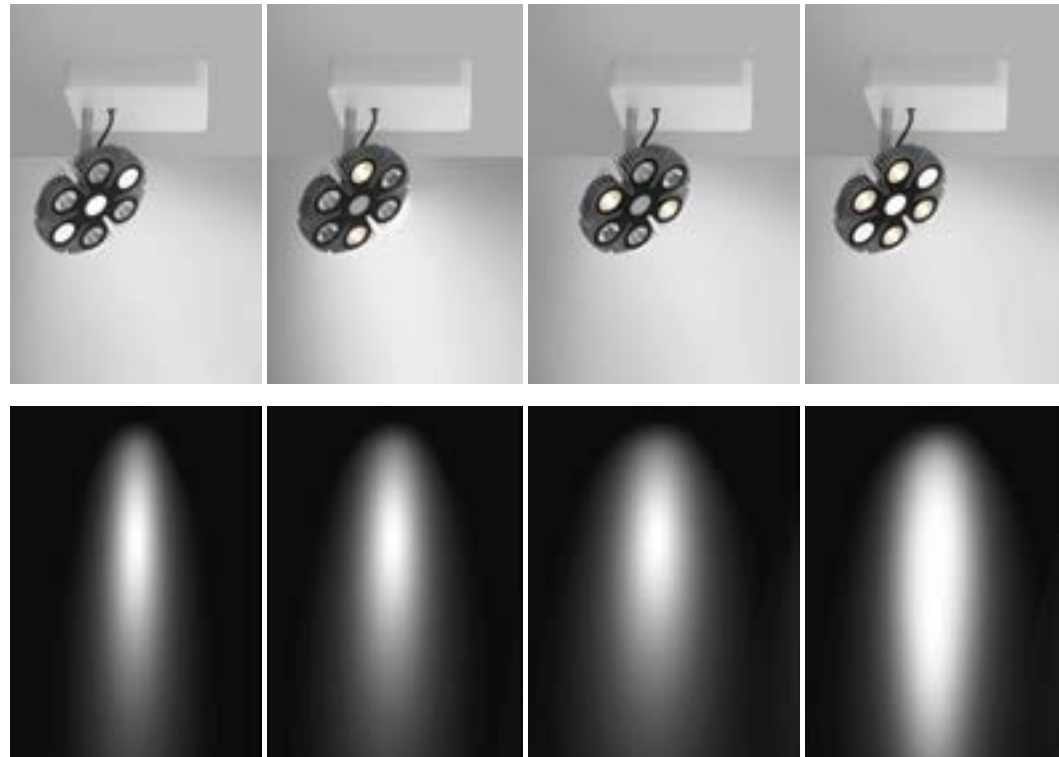

## ↪ LOT REFLECTOR

Silver

05

MacAdam 2SDCM  
Life L70 (9K) 50000h  
CRI=90  
Control DMX/RDM  
DMX 2 footprint

IP20

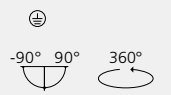

### TRACK

W	Weight	Flux tot	CCT	Code
max 70 W	6,0 kg	5600 lm	3000 K	<b>AM04005</b>

To be used in combination with three-phase DALI tracks for DMX use.

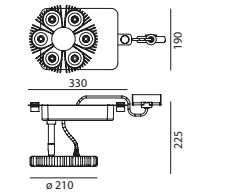
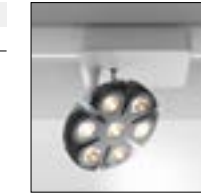

### RECESSED TRIM

W	Weight	Flux tot	CCT	Code
max 70 W	6,0 kg	5600 lm	3000 K	<b>AM02005</b>



∅ 292

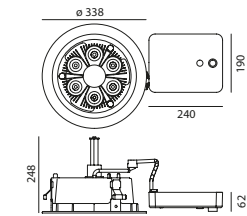

### RECESSED TRIMLESS

W	Weight	Flux tot	CCT	Code
max 70 W	6,0 kg	5600 lm	3000 K	<b>AM01005</b>



∅ 292

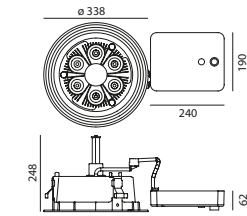

### CEILING

W	Weight	Flux tot	CCT	Code
max 70 W	6,0 kg	5600 lm	3000 K	<b>AM00005</b>

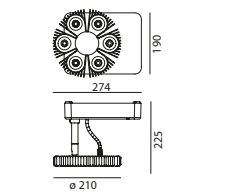

### SUSPENSION

W	Weight	Flux tot	CCT	Code
max 70 W	6,0 kg	5600 lm	3000 K	<b>AM03005</b>

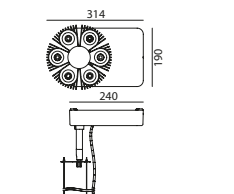

### SUSPENSION TRACK

W	Weight	Flux tot	CCT	Code
max 70 W	6,0 kg	5600 lm	3000 K	<b>AM05005</b>

To be used in combination with three-phase DALI tracks for DMX use.

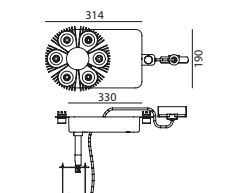



BACKSTAGE

BACKSTAGE

PEOPLE IN MOTION

URBAN ORCHARD  
URBAN ORCHARD  
URBAN ORCHARD  
URBAN ORCHARD

SAGGI SAGGI SAGGI  
SAGGI SAGGI SAGGI  
SAGGI SAGGI SAGGI  
SAGGI SAGGI SAGGI  
SAGGI SAGGI SAGGI  
SAGGI SAGGI SAGGI  
SAGGI SAGGI SAGGI  
SAGGI SAGGI SAGGI  
SAGGI SAGGI SAGGI  
SAGGI SAGGI SAGGI

САЖИ  
СОТЯГОВА

SAWYER  
KIDS  
KIDS  
KIDS



# Cata

Carlotta de Bevilacqua

↪ 2012

→ Patent pending



For further information on Cata  
visit [artemide.com](http://artemide.com)

# Cata optical system



## CATA

### CATADIOPTRIC

High axial intensities with considerable beam collimation.  
High-precision accent lighting.  
Well defined narrow beams.  
Excellent light blending.



## CATA TIR

### TOTAL INTERNAL REFLECTION

Extremely compact dimensions.  
High efficiency.  
Wide availability of beam angles.  
Maximum control of light emission.  
Wide range of optical accessories.



## CATA WIDE

### REFLECTIVE & REFRACTIVE

Soft, homogenous light.  
High efficiency.  
Diffused light effect produced by transparent material.

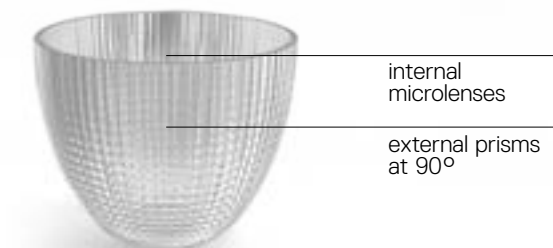
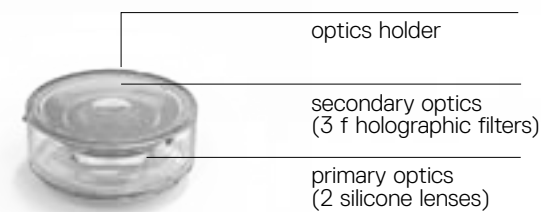
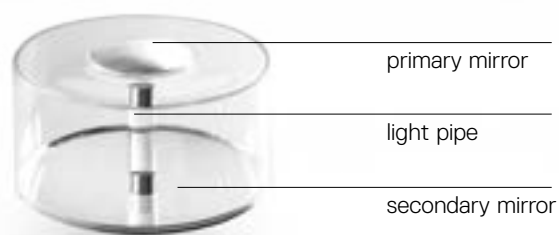

Interchangeable optical unit a 'twist & lock' mechanism.  
Defined, concentrated light beams thanks to an innovative collimation system.

3 beam angles: S (9°), S (14°), XF (66°).

Excellent quality of light.

Cata Tuneable White: adjustable colour temperature from 2700K to 5700K CRI >93 (min.).

Cata Stable White: available as warm white (3000K) and neutral white (4000K) – CRI=80 (min.).

Rotation of 360°, tilt angle of +90°/-90°.

4 installation options: with adaptor for 3-circuit track (ceiling only as envisaged by legislation), with power unit for ceiling installation in the adjustable and fixed version, with power unit for suspension installation in the adjustable version.

Ultra-flat power source (8mm height): DALI dimmable as standard, DALI8 interface hub for Tunable White version.

If mounting on a track, it can be used with button on board unit with memory function.

In all the other mounting modes, optional SwitchDimm operation and resident button with memory function.

Materials: optic in transparent and metallic polycarbonate, heat sink in die-cast polished aluminium, feeder/power supply in transparent polycarbonate, arm in die-cast polished aluminium.

Complies with EN60598-1 standard and other specific standards.



#### OPTICAL UNIT

Cata is equipped with a system of interchangeable optics via a 'twist and lock' mechanism.

S 9°



S 14°



XF 66°



# Cata ↪ Catadioptric

↪ CATA CATADIOPTRIC



Polished Aluminium

In absence of DALI-SwitchDim bus, CATA can be dimmed using the button on the light fitting.

MacAdam 3SDCM  
Life L80 (10K) 55000h  
CRI=80

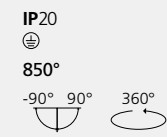

TRACK

W	Weight	CCT	DALI Code
30 W	0,70 kg	3000 K	<b>M057383</b>
		4000 K	<b>M057483</b>

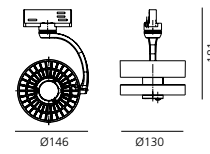

To be used in conjunction with DALI 3-circuit tracks.

CEILING

W	Weight	CCT	DALI-SwitchDim Code
30 W	0,70 kg	3000 K	<b>M057381</b>
		4000 K	<b>M057481</b>

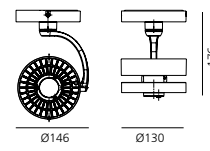

SUSPENSION

W	Weight	CCT	DALI-SwitchDim Code
30 W	0,70 kg	3000 K	<b>M0672W81</b>
		4000 K	<b>M0672N81</b>

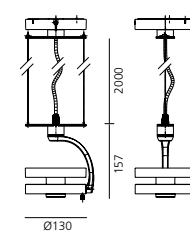

CEILING FIX

W	Weight	CCT	DALI Code
30 W	0,70 kg	3000 K	<b>M0677W81</b>
		4000 K	<b>M0677N81</b>

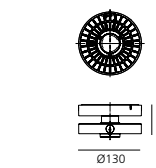

↪ OPTIC

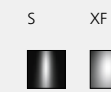

Optical unit 9°

Weight	Beam	Code
0,25 kg	S 9°	<b>M057500</b>
CCT	Flux	
3000 K	1125 lm	
4000 K	1194 lm	

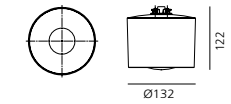
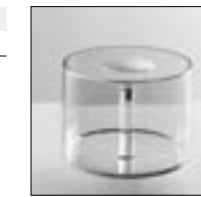

Optical unit 14°

Weight	Beam	Code
0,20 kg	S 14°	<b>M057600</b>
CCT	Flux	
3000 K	946 lm	
4000 K	1004 lm	

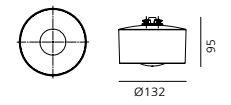

Optical unit 66°

Weight	Beam	Code
0,30 kg	XF 66°	<b>M057810</b>
CCT	Flux	
3000 K	2123 lm	
4000 K	2254 lm	

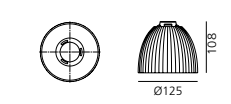

Interchangeable optical unit a 'twist & lock' mechanism.  
 5 available beams: XS (4°), S (16°), WF (28°), XF (56°), WW.  
 2 color temperatures: warm white (3000K) CRI=93 (min.), neutral white (4000K) CRI=90 (min.)  
 Rotation of 360°, tilt angle of +90°/-90°.  
 4 installation options: with adaptor for 3-circuit track (ceiling only as envisaged by legislation), with power unit for ceiling installation in the adjustable and fixed version, with power unit for suspension installation in the adjustable version.  
 Ultra-flat power source (8mm height): DALI dimmable as standard.  
 If mounting on a track, it can be used with button on board unit with memory function.

If using a ceiling and suspension mount, it can be used in SwitchDimm option and with button on board unit with memory function.  
 Materials: optic in transparent polycarbonate and silicone, heat sink in die-cast polished aluminium, feeder/power supply body in transparent polycarbonate, arm in die-cast polished aluminium.  
 Complies with EN60598-1 standard and other specific standards.



**OPTICAL UNIT**

Cata Lens is equipped with a system of interchangeable optics via a 'twist and lock' mechanism.



**Cata**  
 ↷ **TIR**



Polished Aluminium

In absence of DALI-SwitchDim bus, CATA can be dimmed using the button on the light fitting.

MacAdam 2SDCM  
Life L90 (10K)>55400h  
CRI=90

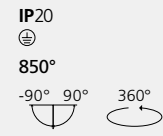

TRACK

W	Weight	CCT	DALI Code
22W	0,70 kg	3000 K	<b>M0569W83</b>
		4000 K	<b>M0569N83</b>

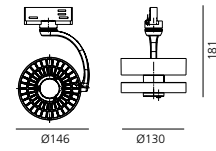

To be used in conjunction with DALI 3-circuit tracks.

CEILING

W	Weight	CCT	DALI-SwitchDim Code
22W	0,70 kg	3000 K	<b>M0569W81</b>
		4000 K	<b>M0569N81</b>

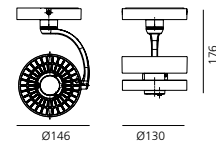

SUSPENSION

W	Weight	CCT	DALI-SwitchDim Code
22W	0,70 kg	3000 K	<b>M0671W81</b>
		4000 K	<b>M0671N81</b>

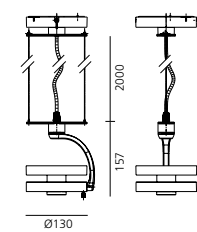

CEILING FIX

W	Weight	CCT	DALI Code
22W	0,70 kg	3000 K	<b>M0676W81</b>
		4000 K	<b>M0676N81</b>

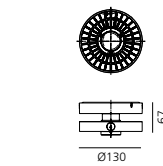

Optical unit XS

Weight	Beam	Code
0,15 kg	XF 4°	<b>M109500</b>
<hr/>		
CCT	Flux	
3000 K	1446 lm	
4000 K	1551 lm	

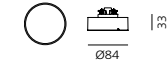

Optical unit S

Weight	Beam	Code
0,15 kg	S 16°	<b>M109600</b>
<hr/>		
CCT	Flux	
3000 K	1638 lm	
4000 K	1758 lm	

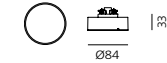

Optical unit F

Weight	Beam	Code
0,15 kg	WF 28°	<b>M109700</b>
<hr/>		
CCT	Flux	
3000 K	1561 lm	
4000 K	1674 lm	

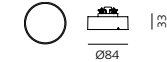

Optical unit XF

Weight	Beam	Code
0,15 kg	XF 56°	<b>M109800</b>
<hr/>		
CCT	Flux	
3000 K	1663 lm	
4000 K	1784 lm	



Optical unit WW

Weight	Beam	Code
0,15 kg	WW	<b>M109900</b>
<hr/>		
CCT	Flux	
3000 K	1616 lm	
4000 K	1734 lm	





Accessories configuration		narrow	spot	flood	wide flood
	1 Glass filter Lens for elliptical emission Soft filter Chromatic filter	●	●	●	●
	Anti-dazzle louvre	●	●	●	●
	Adjustable dowsers	●	●	●	●
	Anti-dazzle louvre + Adjustable dowsers	●	●	●	●
	Anti-dazzle louvre + 1 Glass filter Lens for elliptical emission Soft filter Chromatic filter	●	●	●	●
	Adjustable dowsers + 1 Glass filter Lens for elliptical emission Soft filter Chromatic filter	●	●	●	●
	2 Glass filters Lens for elliptical emission Soft filter Chromatic filter	●	●	●	●

Accessories		Color	Code
	Accessories holder	ⓘ	M057080
	Lens for elliptical emission		M282007
	Soft filter		M056807
	Chromatic filter	● ● ●	M281745 M281755 M281735
	Anti-dazzle louvre	●	M282100
	Adjustable dowsers	●	M059910





Museum Louvre Abu Dhabi, 2017, Jean Nouvel, ph. Michèle Anastasi



# Olmo

Giulio Iacchetti  
↔ 2015



# Olmo is magnetic

48V magnetic track, max. 5 modules with 12 spots and one power unit.  
The junction allows to join the parts at 360° horizontally or vertically.  
Adjustable magnetic LED projectors.  
DALI dimmerable and non-dimmerable version.



Artemide  
App  
↪ on request

Olmo is a system based on a combination of plain optical and mechanical elements: a magnetic adapter and three luminous heads that offer different light beams. The track's structure has a C-section to ensure appropriate structural properties and accommodate an innovative printed circuit board within for power supply. Underneath is a thin iron edge that supports the luminous bodies with a magnetic joint. The suspension tracks ensure maximum mounting flexibility, in that they can be either connected with each other or installed vertically or horizontally, as are connected via an element that ensures power and mechanical connection. Olmo is therefore a system that grows freely and unpredictably to adjust its geometry, look, and lighting performance to space.



For further information on Olmo  
↪ visit [artemide.com](http://artemide.com)

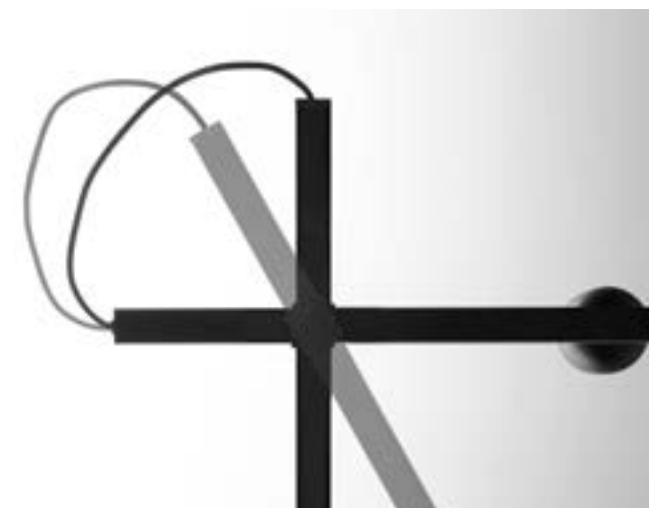

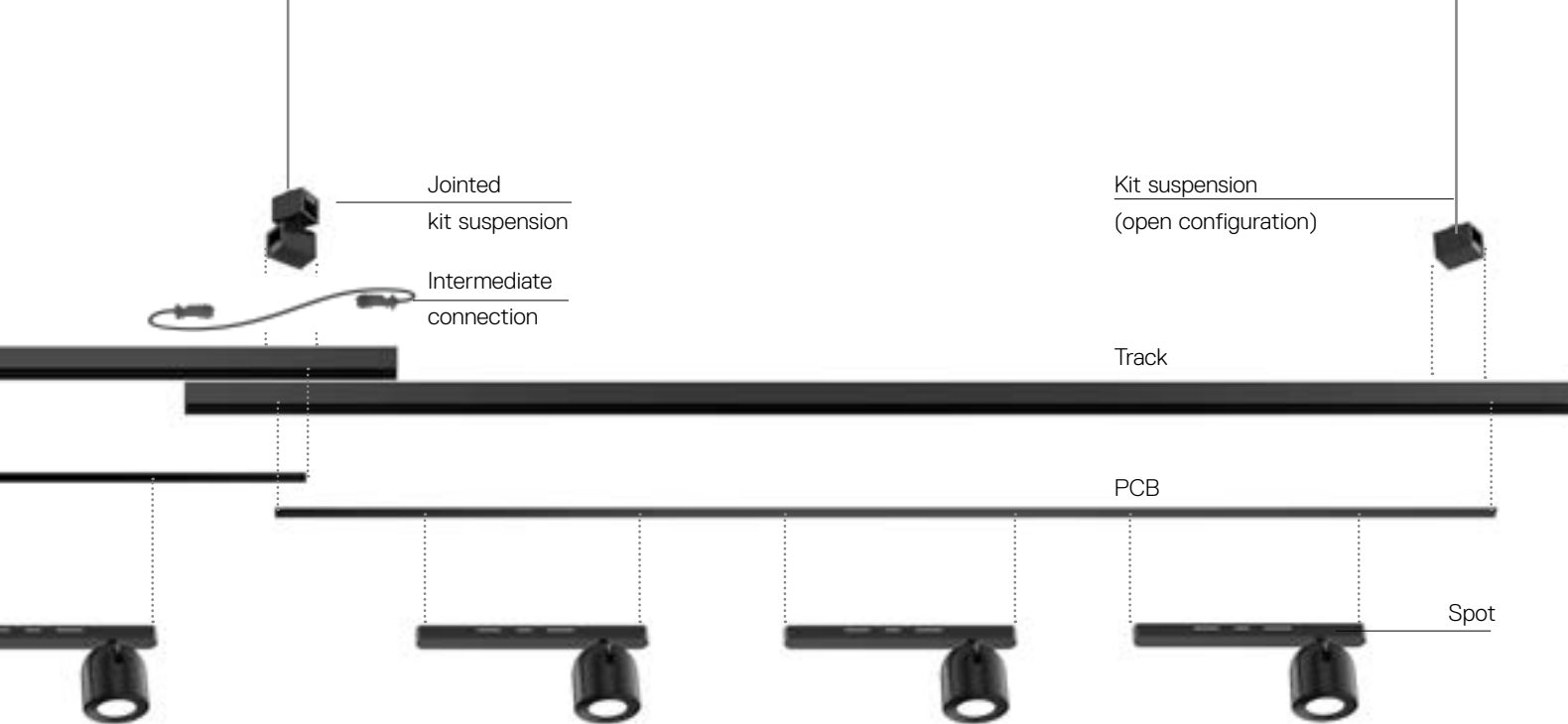

↪ OLMO

White 10    Black 09    F    WF

MacAdam 2SDCM    IP20  
Life L80 (9K)>50000h    ⚡  
CRI=90

MAGNETIC TRACK

Length	Weight	Code
1300 mm	2,30 kg	DGI2700A. 10/09

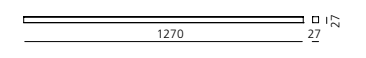

SPOT

W	Beam	Flux	CCT	DALI dimmable Code
16 W	F 22°	1233 lm	2700 K	DGI2700B. 10/09 1Y
		1319 lm	3000 K	DGI2700B. 10/09 1W
	F 29°	1237 lm	2700 K	DGI2700B. 10/09 2Y
		1324 lm	3000 K	DGI2700B. 10/09 2W
	WF 42°	1236 lm	2700 K	DGI2700B. 10/09 3Y
		1322 lm	3000 K	DGI2700B. 10/09 3W

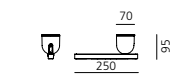
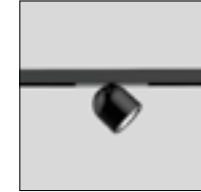

**Accessories**

Code
Suspension kit DGI2700H. 10/09



Suspension junction DGI2700F. 10/09
--

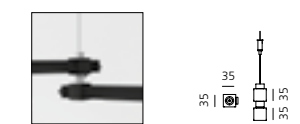

Electrical connection kit DGI2700G. 10/09
--

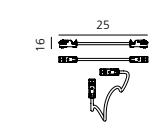

Driver	Undimmable Code	DALI dimmable Code
	DGI2700E. 10/09	DGI2700E. 10/09

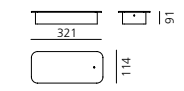

# Olmo components



# Hoy

Foster+Partners  
↪ 2017



For further information on Hoy  
↪ visit [artemide.com](http://artemide.com)

# Hoy typologies

## RECESSED - SEMI RECESSED



TRIM



XF 55°



TRIMLESS



XF 55°



SEMI-RECESSED TRIM

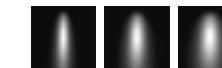

SP 13° FL 30° WF 44°



SEMI-RECESSED TRIMLESS

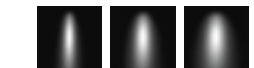

SP 13° FL 30° WF 44°

## LINEAR STAND ALONE - SYSTEM



SUSPENSION



CEILING

## SPOT



SMD

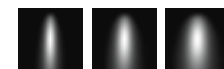

SP 13° FL 30° WF 44°



SMD FIXED



XF 55°

## SPOT MODULE

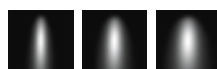

S 13° F 20° WF 28°

## TRACK



TRACK

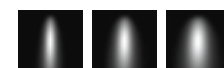

S 16° F 22° WF 32°



TRACK FIXED



XF 55°



# Hoy colors

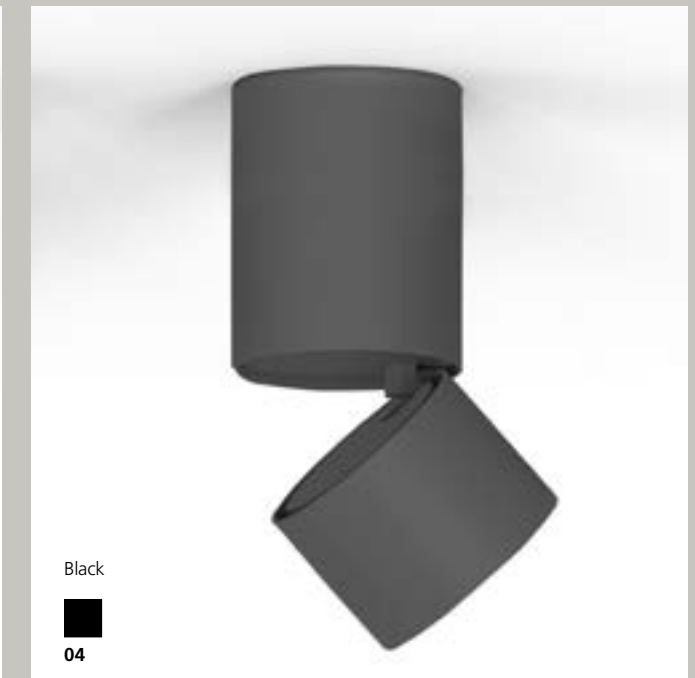

# Hoy Spot rotation

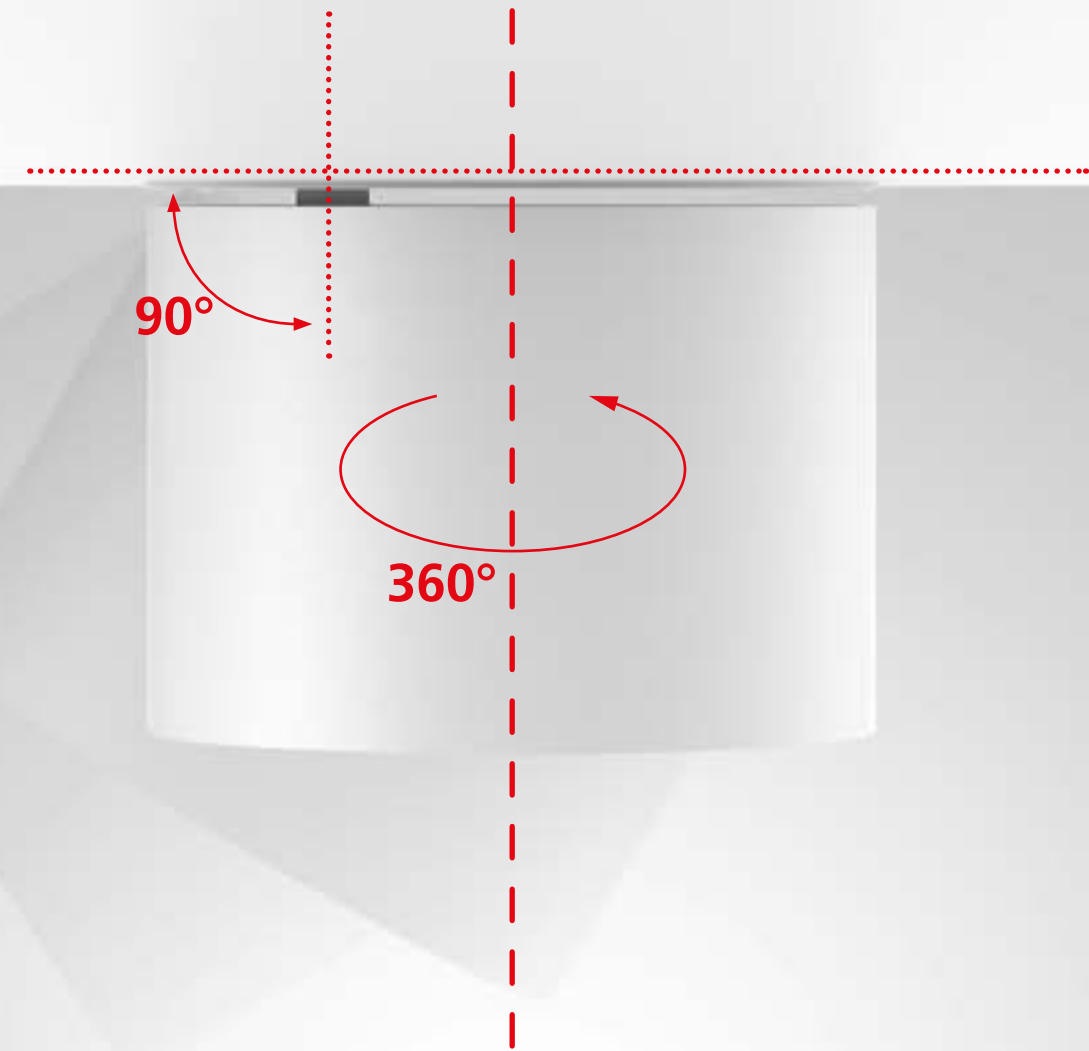

# Hoy ↪ System



# Hoy System linear configuration

→ SUSPENSION FRONT VIEW

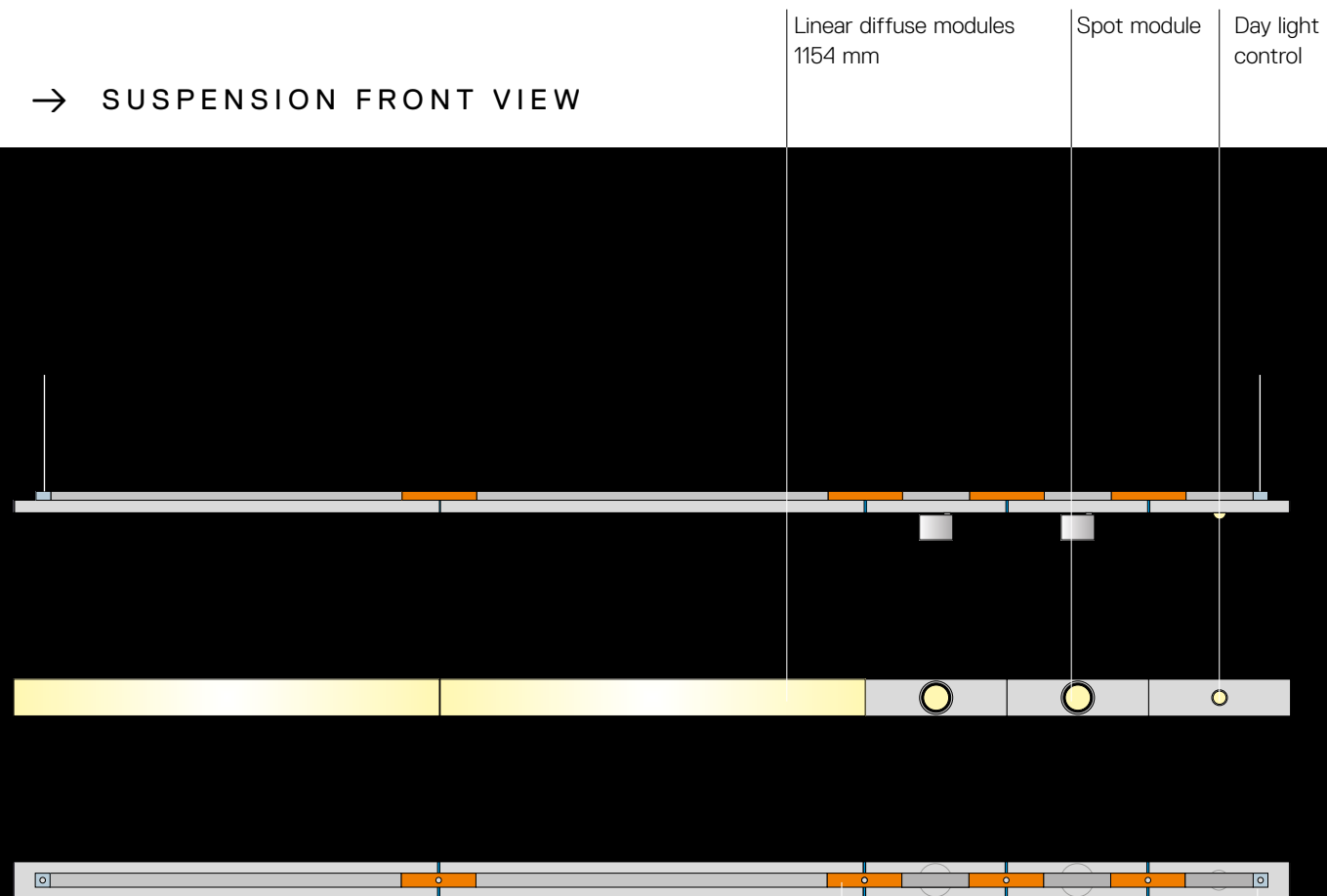

→ CEILING FRONT VIEW

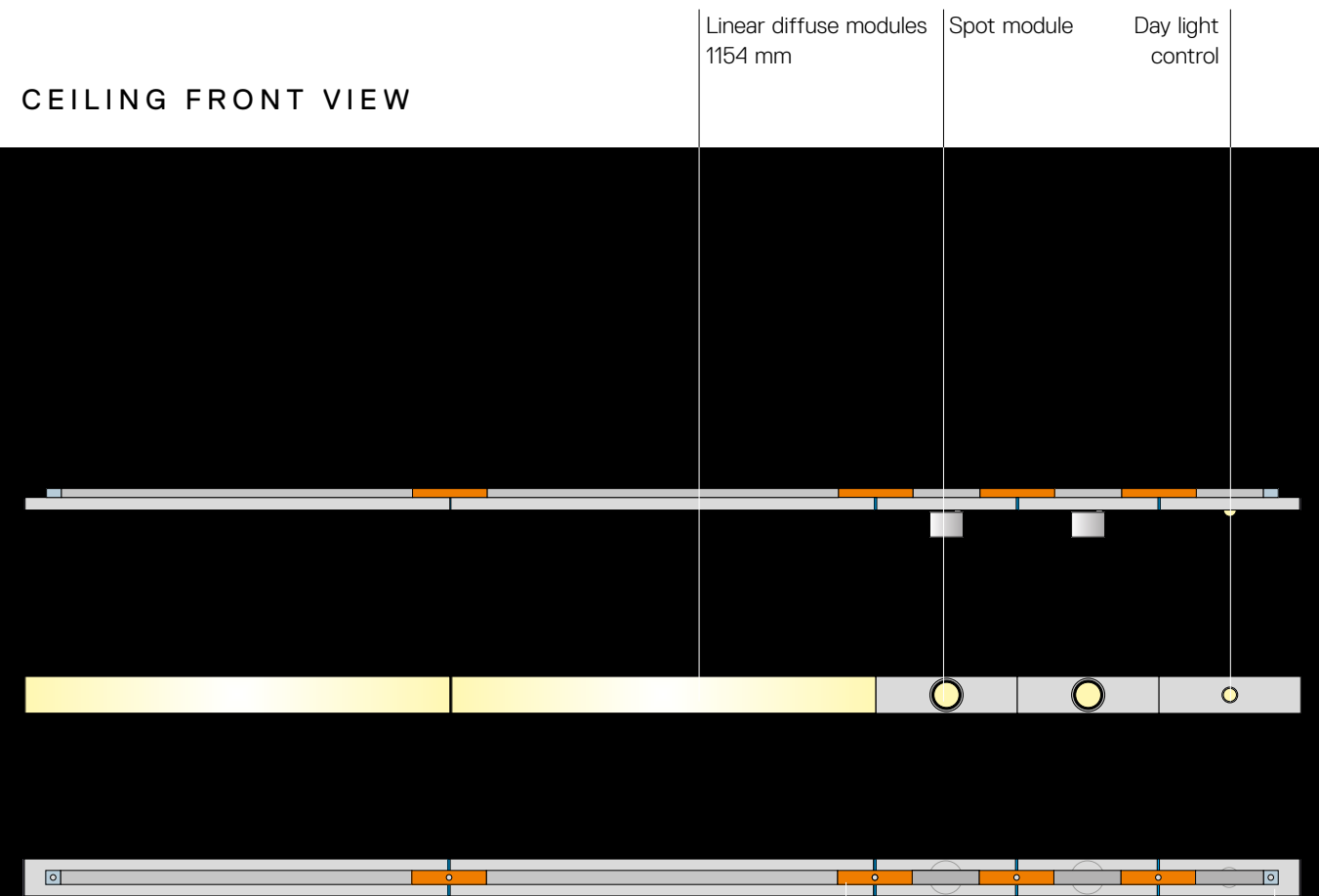

→ SUSPENSION BOTTOM VIEW

Linear feedable  
suspension intermediate joint

Suspension  
feedable end caps kit

The diagram shows a bottom view of the suspension fixture. It is a long, thin white housing with a yellow light strip inside. The fixture is supported by two white brackets. Two vertical lines with arrows point to the bottom of the fixture, labeled 'Linear feedable suspension intermediate joint' and 'Suspension feedable end caps kit'. The fixture is shown in three horizontal positions: top, middle, and bottom.

→ CEILING BOTTOM VIEW

Linear feedable  
ceiling intermediate joint

Ceiling  
feedable end caps kit

The diagram shows a bottom view of the ceiling fixture. It is a long, thin white housing with a yellow light strip inside. The fixture is supported by two white brackets. Two vertical lines with arrows point to the bottom of the fixture, labeled 'Linear feedable ceiling intermediate joint' and 'Ceiling feedable end caps kit'. The fixture is shown in three horizontal positions: top, middle, and bottom.

# Hoy System configuration

→ SUSPENSION FRONT VIEW

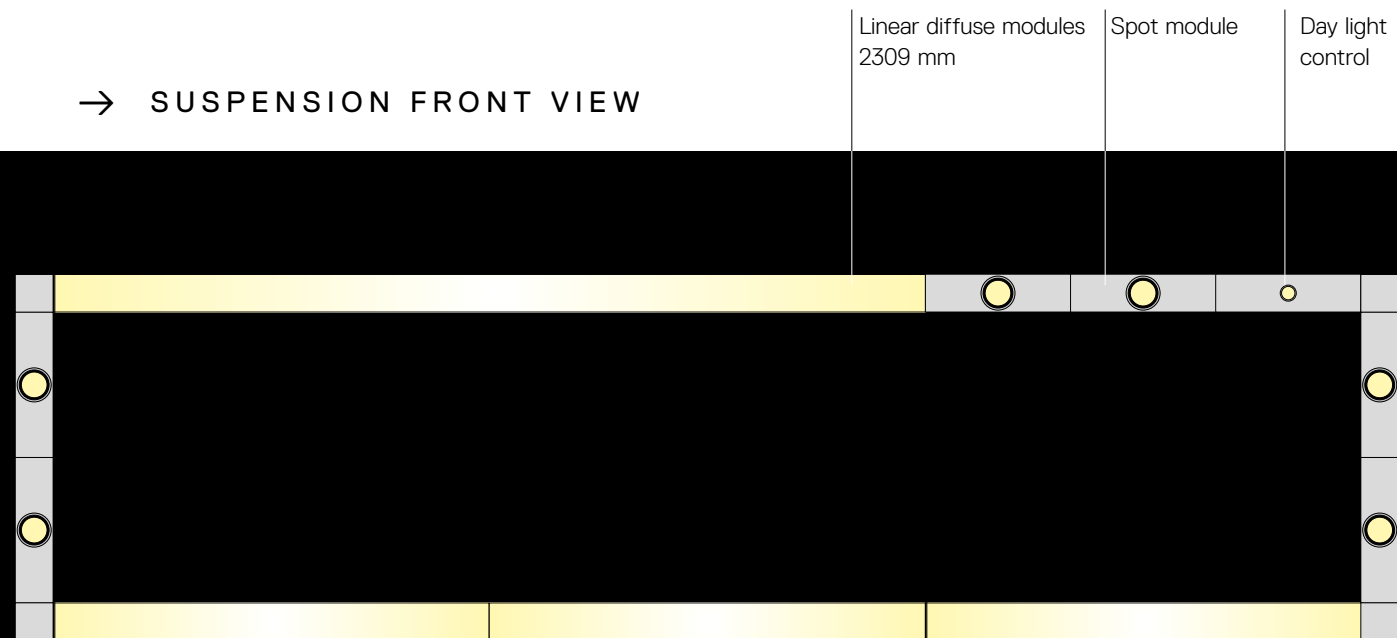

→ CEILING FRONT VIEW

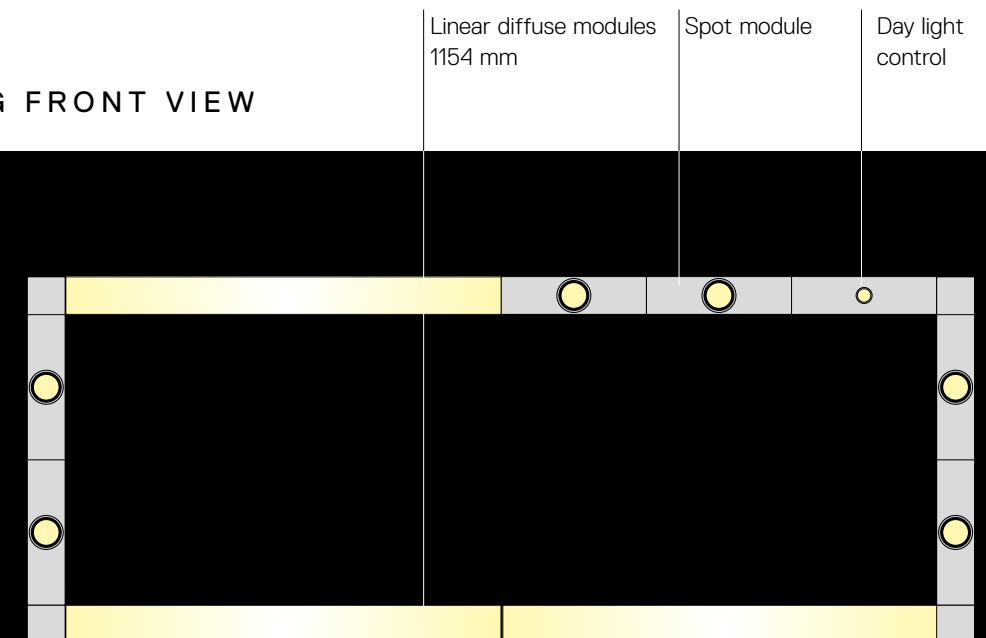

→ SUSPENSION BOTTOM VIEW



Linear feedable  
suspension intermediate joint

90° joint

→ CEILING BOTTOM VIEW

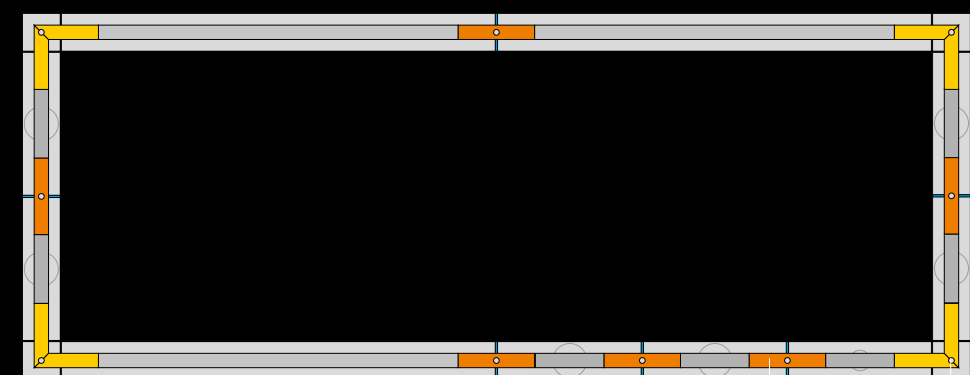

Linear feedable  
ceiling intermediate joint

90° joint

White 01	Black 04	S	F	WF	220/240Vac 50/60Hz electronic ballast included * Driver uses 1 DALI address ** Drivers use 2 DALI addresses	MacAdam 3SDCM Life L70 (6K) 50000h CRI =80 UGR 19	IP20 90° 360°
-------------	-------------	---	---	----	---	--	---------------------

White 01	Black 04
-------------	-------------

LINEAR ELEMENTS

Direct emission				
Length	W	Beam	Flux	CCT
1154 mm	20,5 W	XF	2200 lm	3000K
				4000K
2309 mm	41 W	XF	4400 lm	3000K
				4000K

Undimmable	
Code	
<b>BL001.</b>	01/04
<b>BL002.</b>	01/04
<b>BL101.</b>	01/04
<b>BL102.</b>	01/04

Dimmable DALI*	
Code	
<b>BL004.</b>	01/04
<b>BL005.</b>	01/04
<b>BL104.</b>	01/04
<b>BL105.</b>	01/04

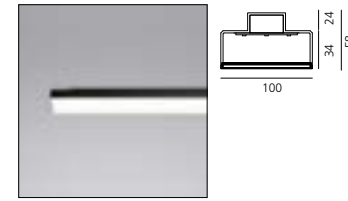

Direct emission + indirect				
Length	W	Beam	Flux	CCT
1154 mm	20,5 W direct	XF	2200 lm	3000K
	10 W indirect		1100 lm	
				4000K
2309 mm	41 W direct	XF	4400 lm	3000K
	10 W indirect		2200 lm	
				4000K

Undimmable	
Code	
<b>BL007.</b>	01/04
<b>BL008.</b>	01/04
<b>BL107.</b>	01/04
<b>BL108.</b>	01/04

Dimmable DALI**	
Code	
<b>BL010.</b>	01/04
<b>BL011.</b>	01/04
<b>BL110.</b>	01/04
<b>BL111.</b>	01/04

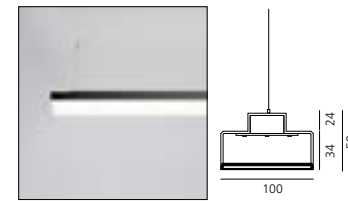

NO LIGHT MODULES

Length
1154 mm
2309 mm

Code
<b>BL012.</b>
<b>BL112.</b>

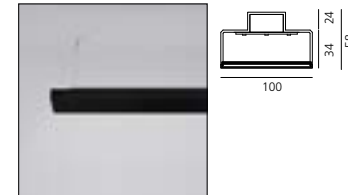





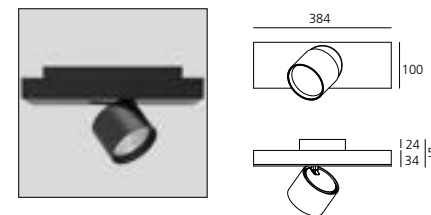

SPOT MODULES

Direct emission			
W	Beam	Flux	CCT
27 W	SP 13°	1900 lm	2700K
			3000K
			4000K
	FL 30°	1912 lm	2700K
			3000K
			4000K
	WF 44°	1891 lm	2700K
			3000K
			4000K

Dimmable DALI	
Code	
<b>BL300.</b>	01/04
<b>BL301.</b>	01/04
<b>BL302.</b>	01/04
<b>BL303.</b>	01/04
<b>BL304.</b>	01/04
<b>BL305.</b>	01/04
<b>BL306.</b>	01/04
<b>BL307.</b>	01/04
<b>BL308.</b>	01/04



	Code
 Suspension feedable end caps kit. including 2 suspension cable (pair)	<b>BL200.</b> 01/04
 Ceiling feedable end caps kit. (pair)	<b>BL206.</b> 01/04
 Suspension intermediate feedable joint including 1 suspension cable and 1 transition joint	<b>BL202.</b> 01/04
 Ceiling intermediate feedable joint including 1 transition joint	<b>BL203.</b> 01/04
 Suspension intermediate feedable joint 2x90° including 1 suspension cable and 2 transition joints	<b>BL212.</b> 01/04
 Ceiling intermediate feedable joint 2x90° including 2 transition joints	<b>BL213.</b> 01/04
 Day Light control module and presence sensor	<b>BL311.</b> 01/04
Power kit for suspension modules. (3 poles cable L. 2.00m)	<b>BL20401</b>
Power kit for suspension modules. (5 poles cable L. 2.00m)	<b>BL20501</b>
Power kit for ceiling modules. (3/5 poles)	<b>BL21400</b>



## ↪ HOY SPOT

White 01	Black 04	S	F	WF	Driver supplied separately.  Fitting to be completed with installation frame.	MacAdam 3SDCM Life L70 (6K) 50000h CRI = 80	IP20
-------------	-------------	---	---	----	---	---	------

### HOY SEMI-RECESSED

W	Beam	Flux	CCT	Code
25 W	SP 13°	1900 lm	2700K	<b>BM000.</b> 01/04
			3000K	<b>BM001.</b> 01/04
			4000K	<b>BM002.</b> 01/04
	FL 30°	1912 lm	2700K	<b>BM003.</b> 01/04
			3000K	<b>BM004.</b> 01/04
			4000K	<b>BM005.</b> 01/04
	WF 44°	1891 lm	2700K	<b>BM006.</b> 01/04
			3000K	<b>BM007.</b> 01/04
		4000K	<b>BM008.</b> 01/04	

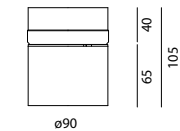

∅ 86 mm

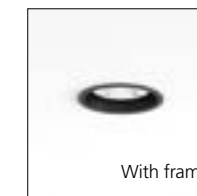
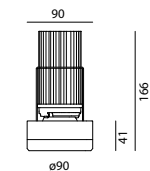

### HOY RECESSED

W	Beam	Flux	CCT	Code
25 W	XF 55°	1605 lm	2700K	<b>BM00900</b>
			3000K	<b>BM01000</b>
			4000K	<b>BM01100</b>

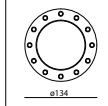

∅ 86 mm

### Accessories

	Code
 Trimless frame	<b>BM05000</b>
 Trim frame Ø 108	<b>BM051.</b> 01/04

Driver	Vac	L <sub>mm</sub>	W <sub>mm</sub>	H <sub>mm</sub>	Code		
36W 700mA	☑	220-240	147	44	22	Undimmable	<b>DV1030</b>
36W 700mA	☑	220-240	103	67	21	Dimmable DALI	<b>M079200</b>
36W 700mA	☑	220-240	103	67	21	Push/1-10V Dimmable	<b>M079300</b>



# Hoy ↪ Spot



# Hoy

## ↪ SMD

### ↪ HOY SMD

White 01	Black 04	S	F	WF	220/240Vac 50/60Hz electronic ballast included	MacAdam 3SDCM Life L70 (6K) 50000h CRI=80	IP20
-------------	-------------	---	---	----	--	---	------

#### HOY SMD ADJUSTABLE

W	Beam	Flux	CCT	Undimmable Code	Dimmable DALI Code
27 W	SP 13°	1900 lm	2700K	<b>BM100.</b> 01/04	<b>BM103.</b> 01/04
			3000K	<b>BM101.</b> 01/04	<b>BM104.</b> 01/04
			4000K	<b>BM102.</b> 01/04	<b>BM105.</b> 01/04
			2700K	<b>BM106.</b> 01/04	<b>BM109.</b> 01/04
	FL 30°	1912 lm	2700K	<b>BM107.</b> 01/04	<b>BM110.</b> 01/04
			3000K	<b>BM108.</b> 01/04	<b>BM111.</b> 01/04
			4000K	<b>BM112.</b> 01/04	<b>BM115.</b> 01/04
			2700K	<b>BM113.</b> 01/04	<b>BM116.</b> 01/04
	WF 44°	1891 lm	2700K	<b>BM114.</b> 01/04	<b>BM117.</b> 01/04
			3000K		
			4000K		

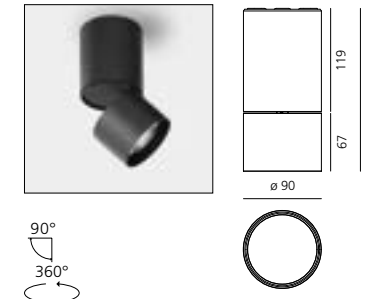

#### HOY SMD FIX

W	Beam	Flux	CCT	Undimmable Code	Dimmable DALI Code
27 W	XF 55°	1605 lm	2700K	<b>BM118.</b> 01/04	<b>BM121.</b> 01/04
			3000K	<b>BM119.</b> 01/04	<b>BM122.</b> 01/04
			4000K	<b>BM120.</b> 01/04	<b>BM123.</b> 01/04

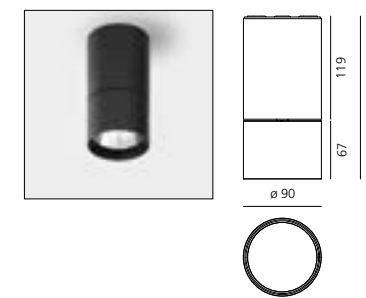



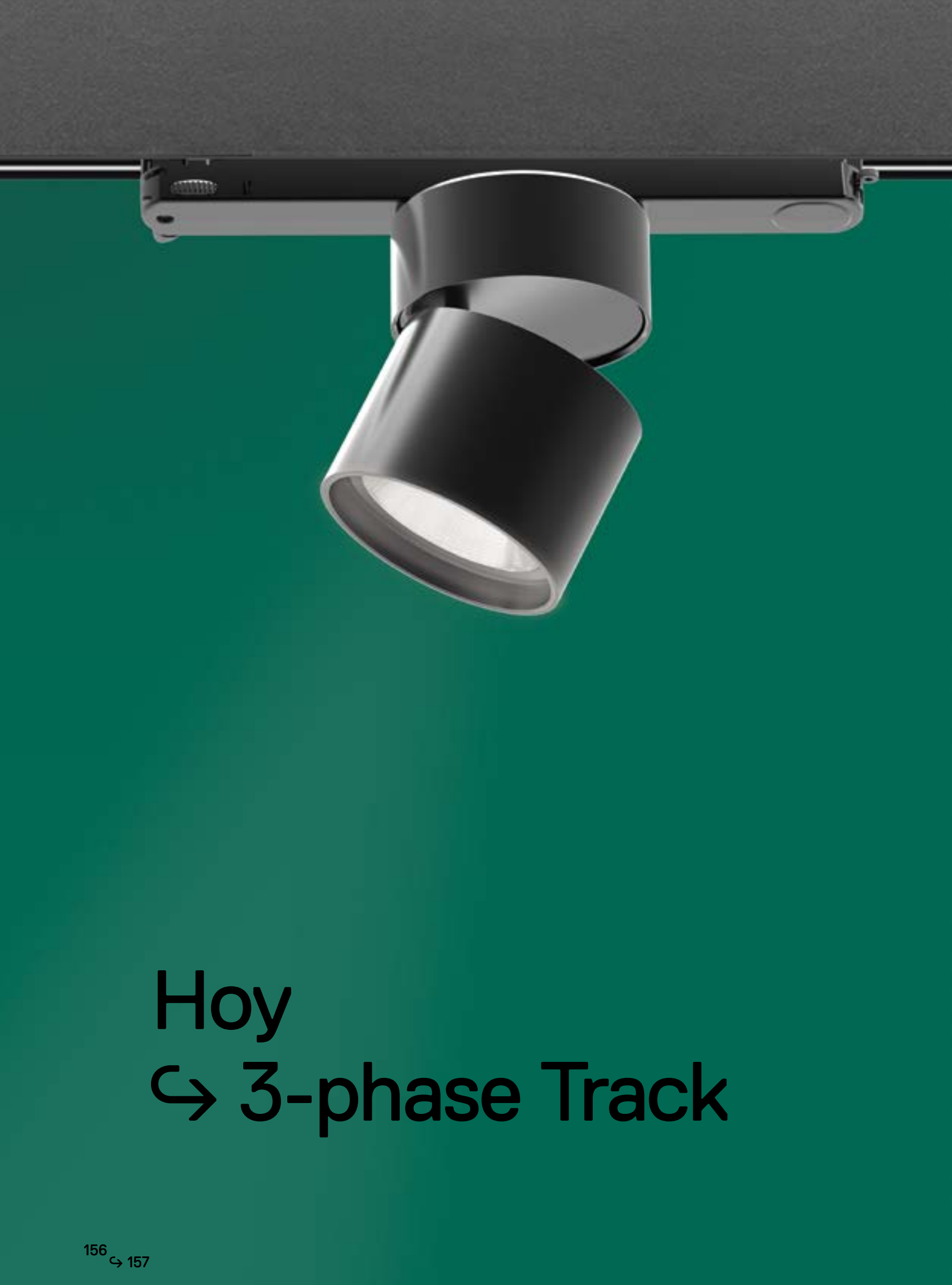

## ↪ HOY 3-PHASE TRACK

White 01	Black 04	S	F	WF	220/240Vac 50/60Hz electronic ballast included	MacAdam 3SDCM Life L70 (6K) 50000h CRI =80	IP20
-------------	-------------	---	---	----	--	--	------

### HOY 3-PHASE TRACK

W	Beam	Flux	CCT	Undimmable Code	Dimmable DALI Code
26 W	SP 13°	1900 lm	2700K	<b>BM200.</b> 01/04	<b>BM203.</b> 01/04
			3000K	<b>BM201.</b> 01/04	<b>BM204.</b> 01/04
			4000K	<b>BM202.</b> 01/04	<b>BM205.</b> 01/04
	FL 30°	1912 lm	2700K	<b>BM209.</b> 01/04	<b>BM212.</b> 01/04
			3000K	<b>BM210.</b> 01/04	<b>BM213.</b> 01/04
			4000K	<b>BM211.</b> 01/04	<b>BM214.</b> 01/04
WF 44°	1891 lm	2700K	<b>BM218.</b> 01/04	<b>BM221.</b> 01/04	
		3000K	<b>BM219.</b> 01/04	<b>BM222.</b> 01/04	
		4000K	<b>BM220.</b> 01/04	<b>BM223.</b> 01/04	

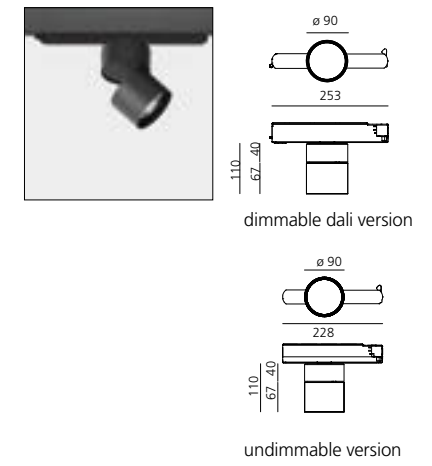

### HOY FIX 3-PHASE TRACK

W	Beam	Flux	CCT	Undimmable Code	Dimmable DALI Code
26 W	XF 55°	1605 lm	2700K	<b>BM227.</b> 01/04	<b>BM230.</b> 01/04
			3000K	<b>BM228.</b> 01/04	<b>BM231.</b> 01/04
			4000K	<b>BM229.</b> 01/04	<b>BM232.</b> 01/04

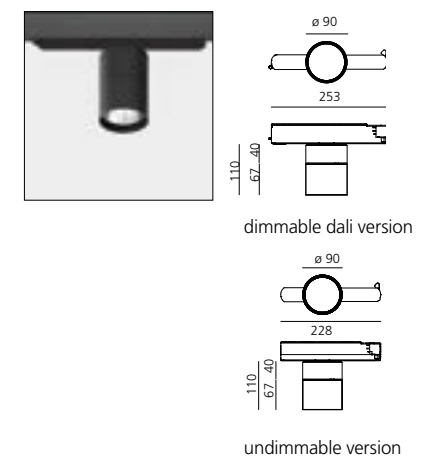

# Hoy

## ↪ 3-phase Track



For further information on Caelum  
↪ visit [artemide.com](http://artemide.com)



# Caelum

Ernesto Gismondi  
↪ 2013

Caelum is designed to provide a versatile lighting solution for the retail sector. It is a highly flexible, multi-functional system, with a high aesthetic and exceptionally high performance.

Caelum is a modular lighting system with an open recessed profile channel, which integrates perfectly with the architectural design.

Optional covers to delineate the channel.

The spotlight kits are available in 2 sizes: Ø 90 mm and Ø 120 mm (diameter of the optical assembly) and are provided with a swivel arm which allows total concealment of the spotlight or, if open, allows the partial or total extraction of the spotlight from the channel.

A double hinge system provides a high degree of regulation of the beam direction.

The spotlights are provided with an electronic power supply.

The extruded elements are installed along both edges of the ceiling cut, creating a channel that can be finished with an optional top cover.



↳ CARTER FOR FALSE CEILING



**Linear profiles**  
500 mm long  
600 mm long  
700 mm long



**Left inner profile**  
For joining two linear profiles on the same level.



**Right inner profile**  
For joining two linear profiles on the same level.



End cap

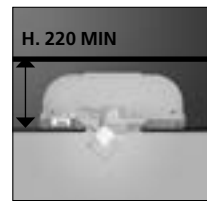

H. 220 MIN

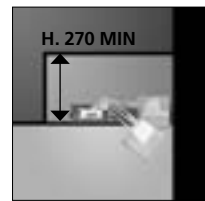

H. 270 MIN

Special application without Carter against the wall.

↳ ALUMINIUM TRIM PROFILES



**Linear aluminium trim profiles**  
500 mm long  
1000 mm long  
2000 mm long  
3000 mm long



**90° inner coupling**  
For joining two trim profiles on the same level.

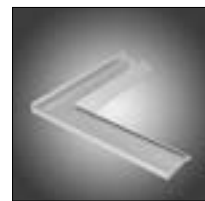

**90° outer coupling**  
For joining two trim profiles on the same level.



Closing end caps

# Caelum structural components

# Caelum configuration

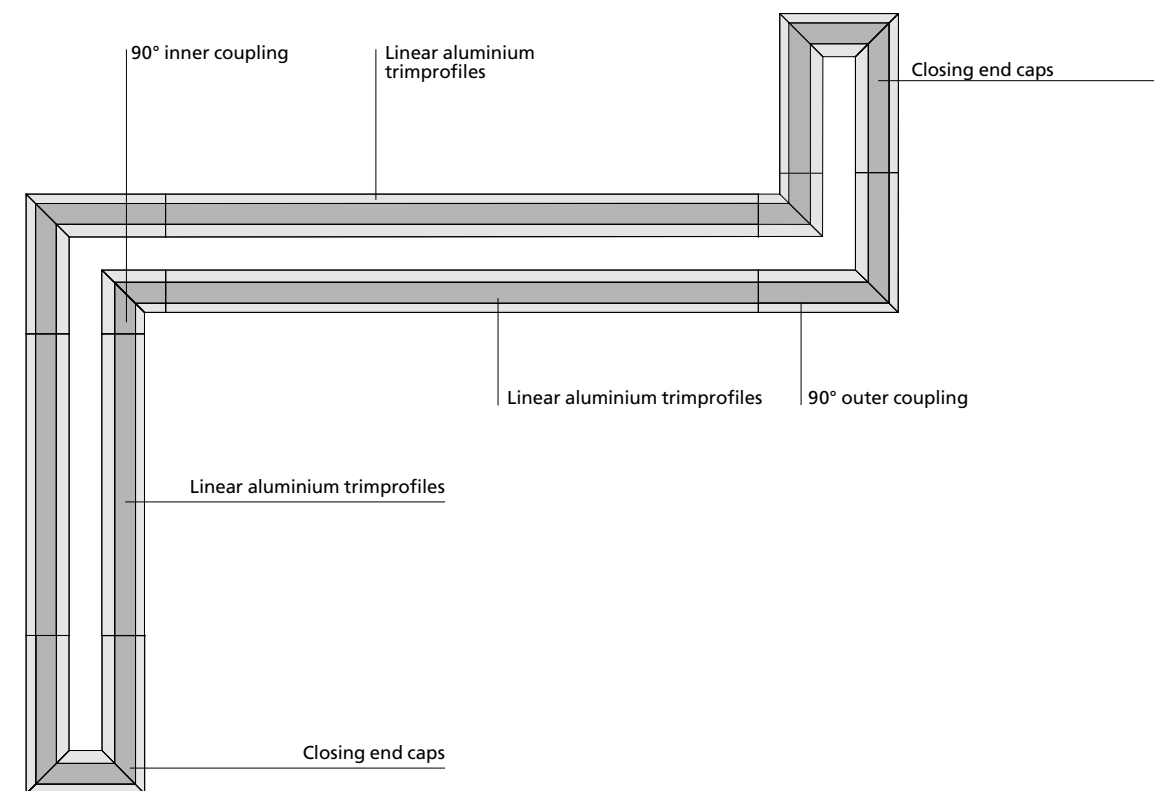
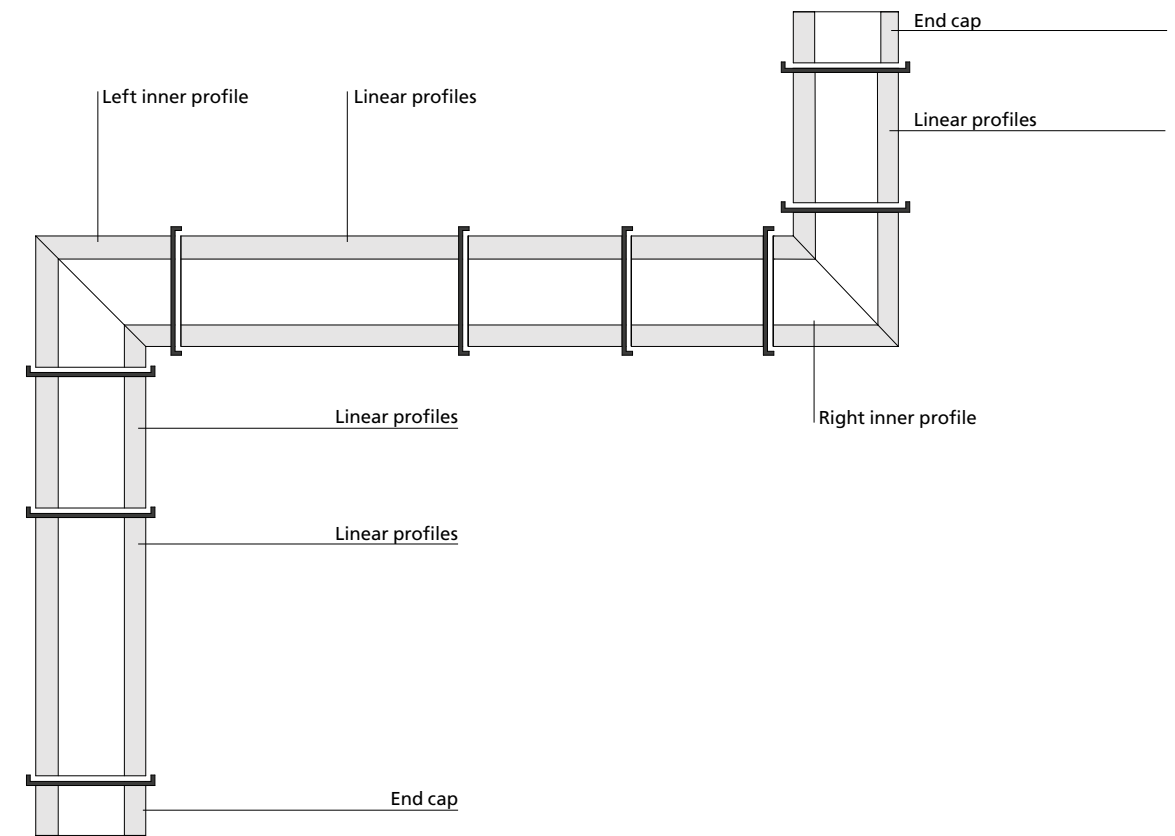

## ↪ CAELUM PROFILE

White Black Blue Bronze

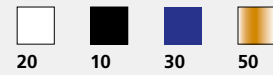

Profile		Code
Length	Weight	
500 mm	3,30 kg	<b>M2827.</b> 20/10/30/50
600 mm	3,90 kg	<b>M2828.</b> 20/10/30/50
700 mm	4,60 kg	<b>M2829.</b> 20/10/30/50

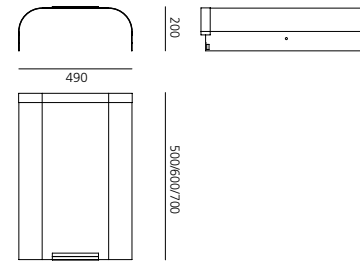

90° profile		Code
Angle	Weight	
left	4,80 kg	<b>M2832.</b> 20/10/30/50
right	4,80 kg	<b>M2833.</b> 20/10/30/50

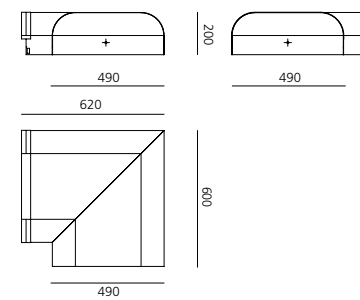
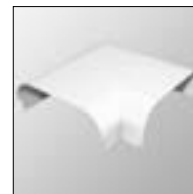

End cap		Code
Weight		
1,60 kg		<b>M2831.</b> 20/10/30/50

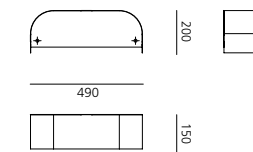

## ↪ CAELUM STRUCTURAL MODULES

White Black



Linear structural module (set of 2)		Code
Length	Weight	
500 mm	1,10 kg	<b>M2841.</b> 20/10
1000 mm	2,20 kg	<b>M2842.</b> 20/10
2000 mm	4,40 kg	<b>M2843.</b> 20/10
3000 mm	6,60 kg	<b>M2844.</b> 20/10

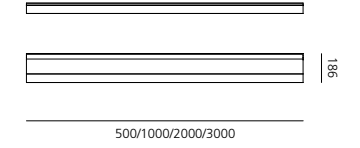

90° structural module		Code
Angle	Weight	
inner	0,30 kg	<b>M2845.</b> 20/10
outer	2,30 kg	<b>M2847.</b> 20/10

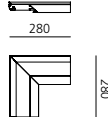
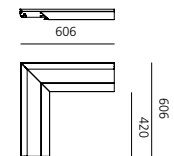
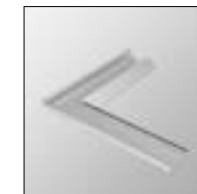

End caps structural module (set of 2)		Code
Weight		
3,30 kg		<b>M2846.</b> 20/10

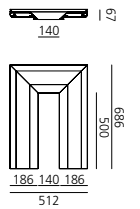

Connectors		Code
Kit power connectors (2pz)		<b>M280900</b>
Kit spacers connector (5pz)		<b>M281000</b>

## ↪ CAELUM 90 LED

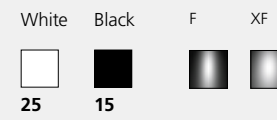

220/240Vac 50/60Hz electronic ballast included.

MacAdam 3SDCM  
Life L80 (9K)>50000h  
CRI<90 (typ.)

IP20  
850°  
-35° 35° 50° 30°  
60°

W	Weight	Beam	Flux	CCT	Code
28W	1,20 kg	F 20°	1873 lm	3000 K	<b>M2756.</b> 25/15
			1930 lm	4000 K	<b>M2757.</b> 25/15
		XF 50°	1758 lm	3000 K	<b>M2760.</b> 25/15
			1811 lm	4000 K	<b>M2761.</b> 25/15

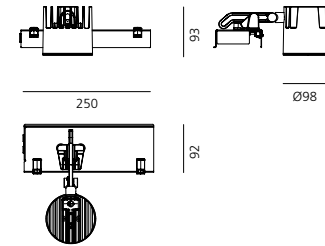

Accessoires		Color	Code
	Lens for elliptical emission		<b>M282007</b>
	Chromatic filter		<b>M281745</b>
			<b>M281755</b>
			<b>M281735</b>
	Anti-dazzle louvre		<b>M282100</b>
	IR filter		<b>M281807</b>
	UV filter		<b>M281907</b>
	Adapter ring		<b>M285007</b>
	Spacing ring		<b>M285107</b>

## ↪ CAELUM 120 LED

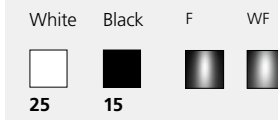

220/240Vac 50/60Hz electronic ballast included.

MacAdam 3SDCM  
Life L80 (9K)>50000h  
CRI<90 (typ.)

IP20  
850°  
-35° 35° 50° 30°  
60°

W	Weight	Beam	Flux	CCT	Code
35 W	1,70 kg	F 16°	2301 lm	3000 K	<b>M2762.</b> 25/15
			2448 lm	4000 K	<b>M2763.</b> 25/15
		WF 36°	2233 lm	3000 K	<b>M2764.</b> 25/15
			2376 lm	4000 K	<b>M2765.</b> 25/15

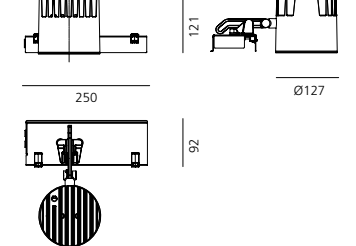

Accessoires		Color	Code
	Lens for elliptical emission		<b>M078700</b>
	Chromatic filter		<b>M078900</b>
			<b>M079000</b>
			<b>M282235</b>
	Anti-dazzle louvre		<b>M078400</b>
	Soft filter		<b>M078800</b>
	UV filter		<b>M282407</b>
	IR filter		<b>M282307</b>
	Spacing ring		<b>M285307</b>

# Una Pro

Carlotta de Bevilacqua  
↪ 2010







High-power LED lighting appliance mounted on a thin (3 mm) flat aluminium sheet with improved heat dissipation.

The patented dissipation system allows to touch the lighting body at all times for adjusting in space, thus establishing a new relation with light.

The heads can accommodate 9, 12, or 16-LED circuits. Available with three different emissions: 6°, 20°, 38°.

The junction allows 358° rotation on two axes and 180° rotation on the third one.



For further information on Una Pro  
→ visit [artemide.com](http://artemide.com)

→ Patent of invention



# Una Pro beam angles

↪ 6° - EXTRA SPOT

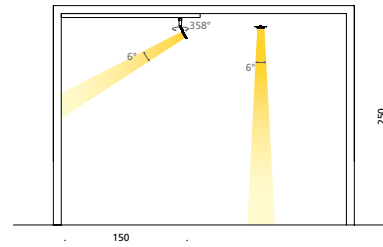
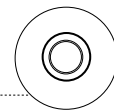

XS = extra spot (<math><8^\circ</math>)

↪ 20° - FLOOD

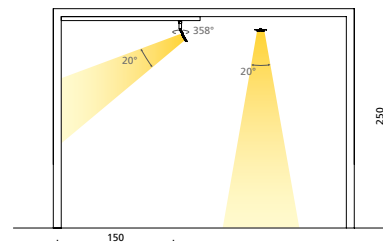
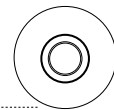

F = flood (15°-30°)

↪ 38° - WIDE FLOOD

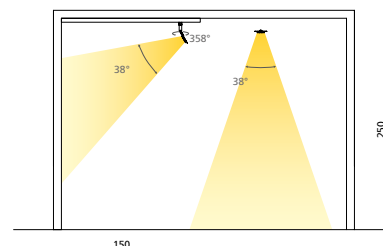
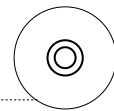

WF = wide flood (30°-45°)

# Una Pro colors



White  
White  
10



Aluminium  
Black  
00.



White



Black



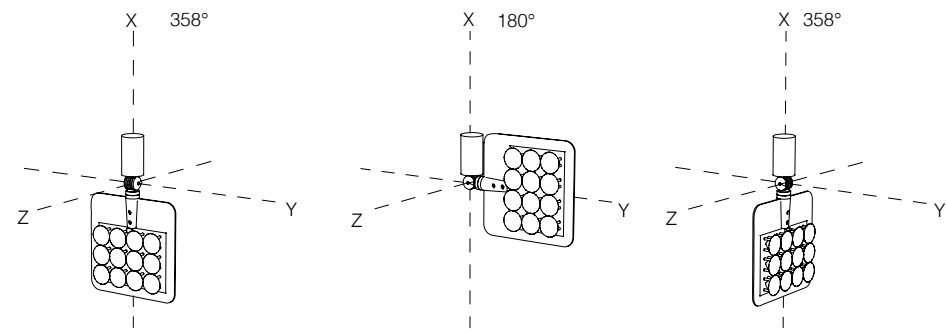

# Una Pro joints

The utmost flexibility of UNA PRO is ensured by a small junction that allows 358° rotation on two axes and 180° rotation on the third one, thus providing full freedom of movement of the three heads in space. Adjustment is easy; based on the study of heat dissipation, the sheet constituting the lamp's body can be freely touched for easy and intuitive adjustment of the light beam.

Flexibility also helps ensure perfect integration with any space and architectural approach. Una Pro can be an unobtrusive entity that stresses the importance of the emitted light, rather than of the appliance.



UNA PRO

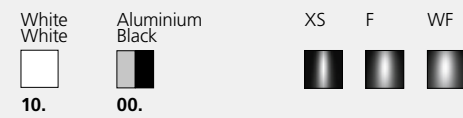

MacAdam 4SDCM  
Life L90 (9K)>54400h  
CRI = 80/85

IP20

UNA PRO WALL-CEILING

W	Weight	Beam	CRI	Flux	CCT
9 LED 10,5 W	0,70 kg	XS 6°	=85	536 lm	3000K
			=80	570 lm	3700K
		F 20°	=85	529 lm	3000K
			=80	563 lm	3700K
		WF 38°	=85	517 lm	3000K
			=80	550 lm	3700K
12 LED 13 W	0,70 kg	XS 6°	=85	726 lm	3000K
			=80	772 lm	3700K
		F 20°	=85	719 lm	3000K
			=80	765 lm	3700K
		WF 38°	=85	689 lm	3000K
			=80	733 lm	3700K
16 LED 20 W	0,70 kg	XS 6°	=85	982 lm	3000K
			=80	1045 lm	3700K
		F 20°	=85	929 lm	3000K
			=80	988 lm	3700K
		WF 38°	=85	915 lm	3000K
			=80	973 lm	3700K

Code
DD0014B. 00/10 A1W
DD0014B. 00/10 A1
DD0014B. 00/10 A2W
DD0014B. 00/10 A2
DD0014B. 00/10 A3W
DD0014B. 00/10 A3
DD0014B. 00/10 B1W
DD0014B. 00/10 B1
DD0014B. 00/10 B2W
DD0014B. 00/10 B2
DD0014B. 00/10 B3W
DD0014B. 00/10 B3
DD0014B. 00/10 C1W
DD0014B. 00/10 C1
DD0014B. 00/10 C2W
DD0014B. 00/10 C2
DD0014B. 00/10 C3W
DD0014B. 00/10 C3

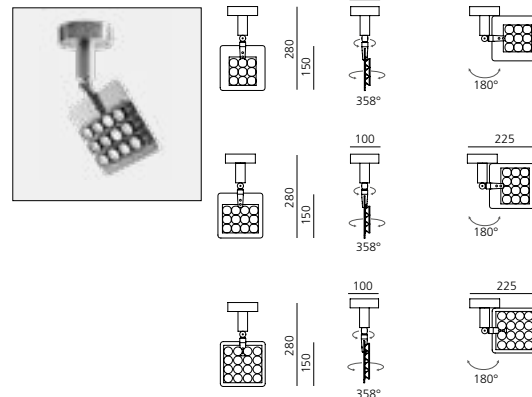

UNA PRO SEMI-RECESSED

W	Weight	Beam	CRI	Flux	CCT
9 LED 10,5 W	0,70 kg	XS 6°	=85	536 lm	3000K
			=80	570 lm	3700K
		F 20°	=85	529 lm	3000K
			=80	563 lm	3700K
		WF 38°	=85	517 lm	3000K
			=80	550 lm	3700K
12 LED 13 W	0,70 kg	XS 6°	=85	726 lm	3000K
			=80	772 lm	3700K
		F 20°	=85	719 lm	3000K
			=80	765 lm	3700K
		WF 38°	=85	689 lm	3000K
			=80	733 lm	3700K
16 LED 20 W	0,70 kg	XS 6°	=85	982 lm	3000K
			=80	1045 lm	3700K
		F 20°	=85	929 lm	3000K
			=80	988 lm	3700K
		WF 38°	=85	915 lm	3000K
			=80	973 lm	3700K

Code
DD0014G. 00/10 A1W
DD0014G. 00/10 A1
DD0014G. 00/10 A2W
DD0014G. 00/10 A2
DD0014G. 00/10 A3W
DD0014G. 00/10 A3
DD0014G. 00/10 B1W
DD0014G. 00/10 B1
DD0014G. 00/10 B2W
DD0014G. 00/10 B2
DD0014G. 00/10 B3W
DD0014G. 00/10 B3
DD0014G. 00/10 C1W
DD0014G. 00/10 C1
DD0014G. 00/10 C2W
DD0014G. 00/10 C2
DD0014G. 00/10 C3W
DD0014G. 00/10 C3

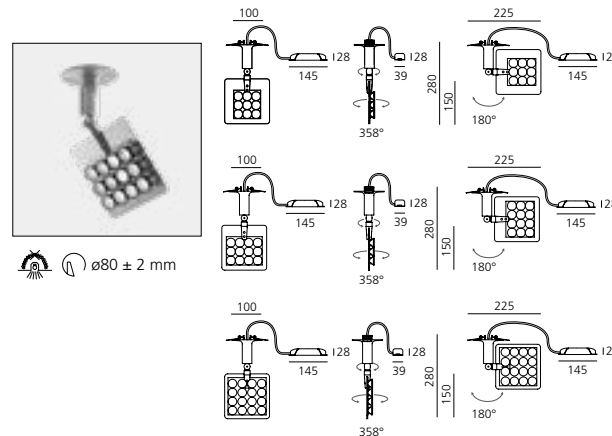

UNA PRO TRACK

W	Weight	Beam	CRI	Flux	CCT
9 LED 10,5 W	0,70 kg	XS 6°	=85	536 lm	3000K
			=80	570 lm	3700K
		F 20°	=85	529 lm	3000K
			=80	563 lm	3700K
		WF 38°	=85	517 lm	3000K
			=80	550 lm	3700K
12 LED 13 W	0,70 kg	XS 6°	=85	726 lm	3000K
			=80	772 lm	3700K
		F 20°	=85	719 lm	3000K
			=80	765 lm	3700K
		WF 38°	=85	689 lm	3000K
			=80	733 lm	3700K
16 LED 20 W	0,70 kg	XS 6°	=85	982 lm	3000K
			=80	1045 lm	3700K
		F 20°	=85	929 lm	3000K
			=80	988 lm	3700K
		WF 38°	=85	915 lm	3000K
			=80	973 lm	3700K

Code
DD0014R. 00/10 A1W
DD0014R. 00/10 A1
DD0014R. 00/10 A2W
DD0014R. 00/10 A2
DD0014R. 00/10 A3W
DD0014R. 00/10 A3
DD0014R. 00/10 B1W
DD0014R. 00/10 B1
DD0014R. 00/10 B2W
DD0014R. 00/10 B2
DD0014R. 00/10 B3W
DD0014R. 00/10 B3
DD0014R. 00/10 C1W
DD0014R. 00/10 C1
DD0014R. 00/10 C2W
DD0014R. 00/10 C2
DD0014R. 00/10 C3W
DD0014R. 00/10 C3

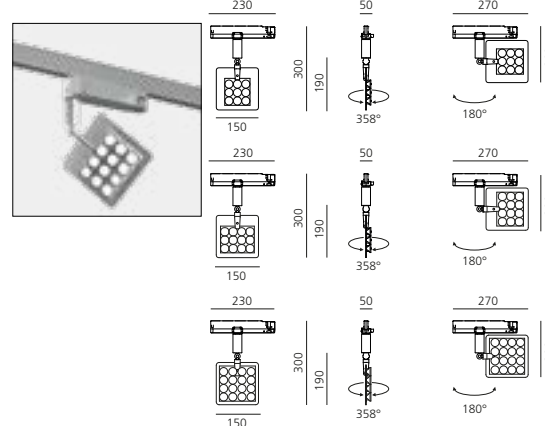

Florm - Showroom, NY | 2017

Florm Showroom, Milan | 2015



Larte, Milan | 2013





# 37 Cube

Carlotta de Bevilacqua  
Paola di Arianello  
↪ 2011

Minimal dimensions, material and energy consumption:  
37mmx37mmx37mm.

Effective and precise accent lighting with only 8W of total  
power consumption.

Maximum flexibility: rotation 360°,  
tilt angle +90°/-90°.

2 installation options available: with control gear for mounting  
within Algorithmo product range or base plate for semi-recessed  
installation.

Option of installation inside Algorithmo modules.

Materials: body in anodised aluminium, translucent cover in  
polycarbonate.

Complies with EN60598-1 standard and other specific standards.

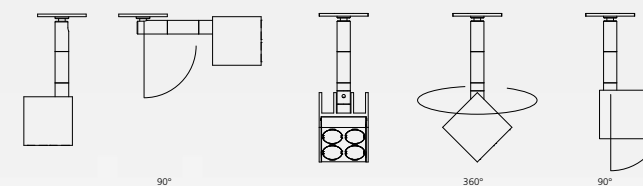

For further information on 37 Cube  
↪ visit [artemide.com](http://artemide.com)

## ↪ 37 CUBE

Anodised aluminium    S    F    WF    220/240Vac 50/60Hz  
 electronic ballast included.    MacAdam 4SDCM    IP20  
 Life L70 (6K) > 50000h    650°  
 CRI= 80 (min.)

04

90°    360°

### 37 CUBE SEMI-RECESSED

W	Weight	Beam	Flux	CCT	Undimmable Code
8 W	0,21 kg	S 14°	483 lm	3000 K	<b>M028504</b>
			517 lm	4000 K	<b>M028604</b>
		F 18°	463 lm	3000 K	<b>M028704</b>
			495 lm	4000 K	<b>M028804</b>
		WF 30°	468 lm	3000 K	<b>M028904</b>
			501 lm	4000 K	<b>M029004</b>

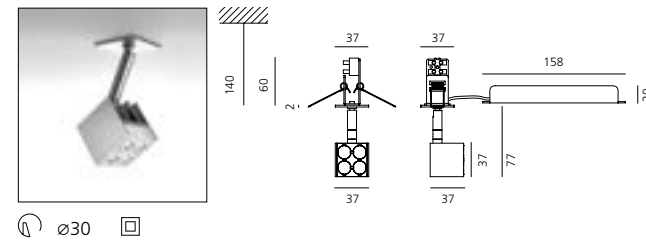

### KIT CONTAINING 3 PROJECTORS FOR ALGORITHM SYSTEM

W	Weight	Beam	Flux	CCT	Undimmable Code
3x8 W	0,47 kg	S 14°	3x483 lm	3000 K	<b>M029100</b>
			3x517 lm	4000 K	<b>M029400</b>
		F 18°	3x463 lm	3000 K	<b>M029200</b>
			3x495 lm	4000 K	<b>M029500</b>
		WF 30°	3x468 lm	3000 K	<b>M029300</b>
			3x501 lm	4000 K	<b>M029600</b>



For Algorithm, please see page 408

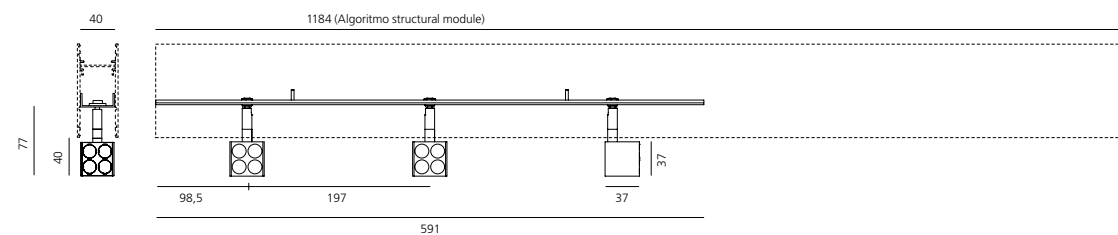

Art&Food, Triennale di Milano, Milano (It), 2015, Studio Italo Rota, ph. Federico Villa



For further information on Pad  
↳ visit [artemide.com](http://artemide.com)



# Pad / Pad Square

Carlotta de Bevilacqua

↳ 2010

Compact dimensions:

PAD, 85mm x 170mm x 16mm

PAD Square, 168mm x 170mm x 16mm

Ultra-flat power source (8mm height): high efficiency and extraordinary versatile power input from 100 to 240v, 50 and 60 Hz.

Optimized thermal management: passive cooling system based on the extension of aluminium surface and partition of the LED sources (PAD 12 LED-12W PAD SQUARE 24 LED-24W).

2 sizes and power:

PAD (12LED-14,5W total load, 85mm x 170mm x 16mm)

PAD Square (24LED-29W total load, 168mm x 170mm x 16mm).

4 installation options: with adaptor for 3-circuit track, with gear plate for mounting within Algoritmo product range, wall/ceiling mounted version, or base plate for semi-recessed mounting.

Wall/ceiling and semi-recessed versions available with SwitchDim.

Materials: body in extruded aluminium, transparent cover in polycarbonate, translucent cover in polycarbonate, joint in die-cast aluminium.

Complies with EN60598-1 standard and other specific standards.





# Pad / Pad Square thermal management

# Pad / Pad Square joints

**Thermal management**  
The uniform fragmentation of LED sources provides optimized heat dissipation.

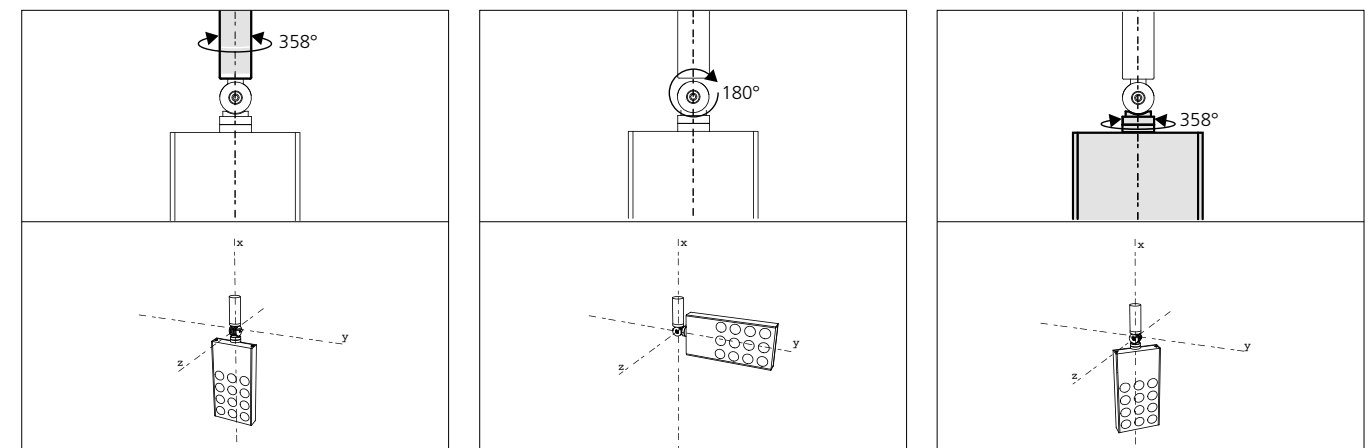

↳ PAD

Gloss anodised S F WF 220/240Vac 50/60Hz electronic ballast included. MacAdam 4SDCM Life L70 (14K) > 81600h CRI=80 (typ.) IP40 650° -90° 90° 358°

PAD TRACK

W	Weight	Beam	Flux	CCT	Undimmable Code
14,5 W	0,42 kg	S 12°	825 lm	3000 K	<b>M200003</b>
			880 lm	4000 K	<b>M200103</b>
		F 24°	825 lm	3000 K	<b>M200203</b>
			880 lm	4000 K	<b>M200303</b>
		WF 36°	805 lm	3000 K	<b>M200403</b>
			855 lm	4000 K	<b>M200503</b>

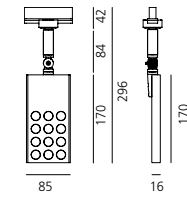

PAD KIT FOR ALGORITMO SYSTEM

W	Weight	Beam	Flux	CCT	Undimmable Code
14,5 W	0,42 kg	S 12°	825 lm	3000 K	<b>M200002</b>
			880 lm	4000 K	<b>M200102</b>
		F 24°	825 lm	3000 K	<b>M200202</b>
			880 lm	4000 K	<b>M200302</b>
		WF 36°	805 lm	3000 K	<b>M200402</b>
			855 lm	4000 K	<b>M200502</b>

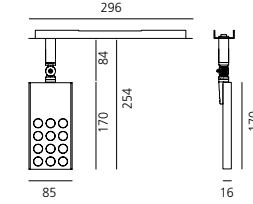

For Algoritmo, please see page 408

PAD CEILING

W	Weight	Beam	Flux	CCT	SwitchDim Code
14,5 W	0,74 kg	S 12°	825 lm	3000 K	<b>M200001</b>
			880 lm	4000 K	<b>M200101</b>
		F 24°	825 lm	3000 K	<b>M200201</b>
			880 lm	4000 K	<b>M200301</b>
		WF 36°	805 lm	3000 K	<b>M200401</b>
			855 lm	4000 K	<b>M200501</b>

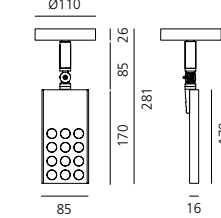

PAD SEMI-RECESSED

W	Weight	Beam	Flux	CCT	SwitchDim Code
14,5 W	0,73 kg	S 12°	825 lm	3000 K	<b>M200004</b>
			880 lm	4000 K	<b>M200104</b>
		F 24°	825 lm	3000 K	<b>M200204</b>
			880 lm	4000 K	<b>M200304</b>
		WF 36°	805 lm	3000 K	<b>M200404</b>
			855 lm	4000 K	<b>M200504</b>

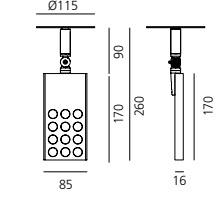

↳ PAD SQUARE

Gloss anodised S F WF 220/240Vac 50/60Hz electronic ballast included. MacAdam 4SDCM Life L70 (14K) > 81600h CRI=80 (typ.) IP40 650° -90° 90° 358°

PAD SQUARE TRACK

W	Weight	Beam	Flux	CCT	Undimmable Code
29 W	0,65 kg	S 12°	1650 lm	3000 K	<b>M201503</b>
			1760 lm	4000 K	<b>M201603</b>
		F 24°	1650 lm	3000 K	<b>M201703</b>
			1760 lm	4000 K	<b>M201803</b>
		WF 36°	1610 lm	3000 K	<b>M201903</b>
			1710 lm	4000 K	<b>M202003</b>

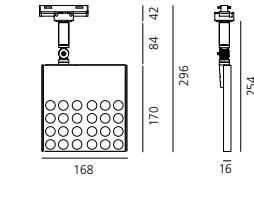

PAD SQUARE KIT FOR ALGORITMO SYSTEM

W	Weight	Beam	Flux	CCT	Undimmable Code
29 W	0,76 kg	S 12°	1650 lm	3000 K	<b>M201502</b>
			1760 lm	4000 K	<b>M201602</b>
		F 24°	1650 lm	3000 K	<b>M201702</b>
			1760 lm	4000 K	<b>M201802</b>
		WF 36°	1610 lm	3000 K	<b>M201902</b>
			1710 lm	4000 K	<b>M202002</b>

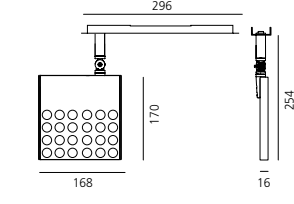

For Algoritmo, please see page 408

PAD SQUARE CEILING

W	Weight	Beam	Flux	CCT	Undimmable Code
29 W	0,98 kg	S 12°	1650 lm	3000 K	<b>M201501</b>
			1760 lm	4000 K	<b>M201601</b>
		F 24°	1650 lm	3000 K	<b>M201701</b>
			1760 lm	4000 K	<b>M201801</b>
		WF 36°	1610 lm	3000 K	<b>M201901</b>
			1710 lm	4000 K	<b>M202001</b>

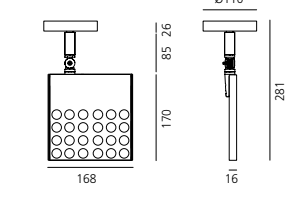

PAD SQUARE SEMI-RECESSED

W	Weight	Beam	Flux	CCT	Undimmable Code
29 W	0,97 kg	S 12°	1650 lm	3000 K	<b>M201504</b>
			1760 lm	4000 K	<b>M201604</b>
		F 24°	1650 lm	3000 K	<b>M201704</b>
			1760 lm	4000 K	<b>M201804</b>
		WF 36°	1610 lm	3000 K	<b>M201904</b>
			1710 lm	4000 K	<b>M202004</b>

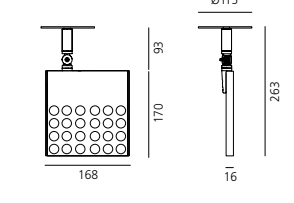



## ↪ EXTERNAL 3-PHASE TRACK 230V

White Black



### TRACK

#### Length

1000 mm  
2000 mm  
3000 mm  
4000 mm

#### Code

**TK001.** 01/04  
**TK002.** 01/04  
**TK003.** 01/04  
**TK004.** 01/04

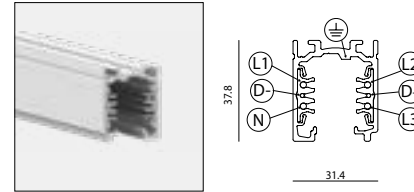

### Accessories

Image	Description	Code
	End cap	<b>TK005.</b> 01/04
	Power supply end cap Earth conductor on the left.	<b>TK006.</b> 01/04
	Power supply end cap Earth conductor on the right.	<b>TK007.</b> 01/04
	Universal hook Maximum load 10 kg	<b>TK200.</b> 01/04
	Kit suspension cables L. 1500 mm L. 3000 mm L. 5000 mm	<b>TK20100</b> <b>TK20200</b> <b>TK20300</b>
	Stem kit L. 1000 mm	<b>TK204.</b> 01/04
	Plastic cup for steel cable Ø 1,5 mm	<b>TK20501</b>
	T bracket for suspension	<b>TK20600</b>
	Universal adapter 6 conductors	<b>TK207.</b> 01/04
	4 conductors	<b>TK208.</b> 01/04
	Accessory for ceiling installation	<b>TK209.</b> 01/04

### Joint

Image	Description	Code
	Recessed joint	<b>TK008.</b> 01/04
	Linear joint	<b>TK009.</b> 01/04
	90° joint Internal earth conductor.	<b>TK011.</b> 01/04
	90° joint External earth conductor.	<b>TK010.</b> 01/04
	3-way joint Earth conductor on right.	<b>TK012.</b> 01/04
	3-way joint Earth conductor on left.	<b>TK013.</b> 01/04
	4-way joint	<b>TK014.</b> 01/04
	Flexible joint	<b>TK015.</b> 01/04

## ↪ RECESSED 3-PHASE TRACK 230V

White Black



### TRACK

#### Length

2000 mm  
3000 mm  
4000 mm

#### Code

**TK102** 01/04  
**TK103** 01/04  
**TK104** 01/04

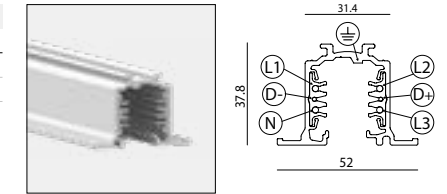

### Accessories

Image	Description	Code
	End cap	<b>TK105.</b> 01/04
	Power supply end cap Earth conductor on the left.	<b>TK108.</b> 01/04
	Power supply end cap Earth conductor on the right.	<b>TK107.</b> 01/04
	Universal adapter 6 conductors	<b>TK207.</b> 01/04
	4 conductors	<b>TK208.</b> 01/04

### Joint

Image	Description	Code
	Recessed joint	<b>TK106.</b> 01/04

The system is a 3 phase mixed system with two additional conductors intended to manage a general data signal (for example DALI, DMX, lon, eib, etc.).

The system is EN 60570 certified and its installation must be accomplished by highly qualified person.

There are four possible installation systems: directly on ceiling or on wall, using the needlepoints on the track, on ceiling or on wall using a metal clip, hanging by the suspension or recessed without exceeding the maximum loads.

## EXTERNAL 3-PHASE TRACK 230V - EUTRAC

White Black Aluminium



Three-circuit track for surface mounting.

Extruded aluminium profile in white, black or aluminium finish.

Supplied in lengths of up to 4m, cut to measure.

2 versions: standard version with 5 conductors (1 earth, 1 neutral, 3 phases) each with a 2.5mm<sup>2</sup> section, or DALI version with 2 additional conductors allowing dimming of lights fitted with DALI dimmable control gear.

Maximum intensity: 16a across the 3 circuits.

Track is pre-cut every 33cm for fixing.

Wide range of accessories, power supply components and electrical and mechanical connectors.



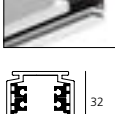
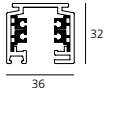
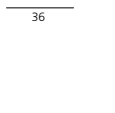
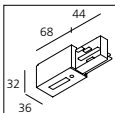
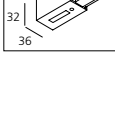
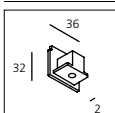
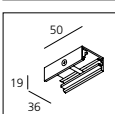
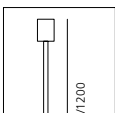
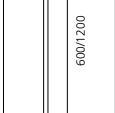
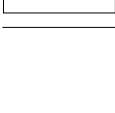

### EXTERNAL 3-PHASE TRACK 230V

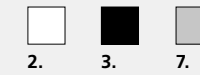
	Standard	DALI
 1000 mm 1,00 kg	<b>Code</b> <b>L1700.</b> 2/3/7 .0	<b>Code</b> <b>L1700.</b> 2/3/7 .1
 2000 mm 2,00 kg	<b>L1701.</b> 2/3/7 .0	<b>L1701.</b> 2/3/7 .1
 3000 mm 3,00 kg	<b>L1702.</b> 2/3/7 .0	<b>L1702.</b> 2/3/7 .1
 4000 mm 4,00 kg	<b>L1703.</b> 2/3/7 .0	<b>L1703.</b> 2/3/7 .1
 Power supply end cap Earth conductor on the left.	<b>L1706.</b> 2/3 .0 7 .0	<b>L1706.</b> 2/3 .1 7 .1
 Power supply end cap Earth conductor on the right.	<b>L1707.</b> 2/3 .0 7 .0	<b>L1707.</b> 2/3 .1 7 .1
 Closure end cap	<b>L1716.</b> 2/3 .0 7 .0	
 Clip for steel cables or pendant coupler	<b>L1717.</b> 2/3 .0 7 .0	
 Stem Ø13 mm / L=600mm	<b>L1704.</b> 2/3 .0	
 Stem Ø13 mm / L=1200mm	<b>L1705.</b> 2/3 .0	
 Can be cut to measure. For use with pendant clip or pendant coupler (on request).		
Suspension cables L. 1.500 mm Eutrac L. 3.000 mm Eutrac L. 6.200 mm Eutrac	<b>L176000</b> <b>L176100</b> <b>L176200</b>	

White Black Aluminium

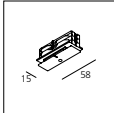
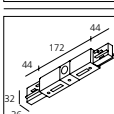
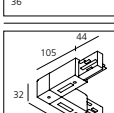
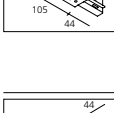
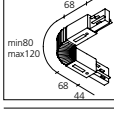
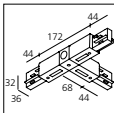
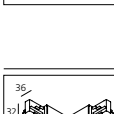
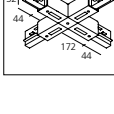

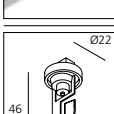



### JOINTS

	Standard	DALI
 Recessed joint	<b>Code</b> <b>L1709.</b> 2/3 .0 7 .0	<b>Code</b> <b>L1709.</b> 2/3 .1 7 .1
 Linear joint	<b>L1710.</b> 2/3 .0 7 .0	<b>L1710.</b> 2/3 .1 7 .1
 90° joint Internal earth conductor.	<b>L1711.</b> 2/3 .0 7 .0	<b>L1711.</b> 2/3 .1 7 .1
 90° joint External earth conductor.	<b>L1712.</b> 2/3 .0 7 .0	<b>L1712.</b> 2/3 .1 7 .1
 Flexible joint	<b>L1715.</b> 2/3 .0	<b>L1715.</b> 2/3 .1
 3-way joint Earth conductor on left.	<b>L1718.</b> 2/3 .0 7 .0	<b>L1718.</b> 2/3 .1 7 .1
 3-way joint Earth conductor on right.	<b>L1713.</b> 2/3 .0 7 .0	<b>L1713.</b> 2/3 .1 7 .1
 4-way joint	<b>L1714.</b> 2/3 .0 7 .0	<b>L1714.</b> 2/3 .1 7 .1
<b>Accessories</b>	<b>Standard</b>	<b>DALI</b>
 Universal adapter 230/240V - 16A	<b>Code</b> <b>L1720.</b> 2/3 .0	<b>Code</b> <b>L1720.</b> 2/3 .1
 Adapter with terminal resistance for DMX signal	<b>L1722.</b> 2/3 .1	
 Universal hook Maximum load 10 kg	<b>L1734.</b> 2/3 .0	
 Accessory for ceiling installation	<b>L1763.</b> 2/3 .0 7 .0	

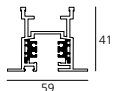
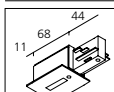
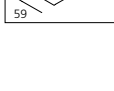
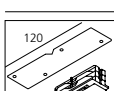
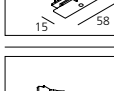
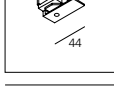
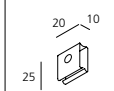

3-phase track for recess mounting.  
 Extruded aluminium profile in white, black or aluminium finish.  
 Supplied in lengths of up to 4m, cut to measure.  
 2 versions: standard version with 5 conductors (1 earth, 1 neutral, 3 phases) each with a 2.5mm<sup>2</sup> section, or DALI version with 2 additional conductors allowing dimming of lights fitted with DALI dimmable control gear.  
 Maximum intensity: 16a across the 3 circuits.  
 Track is pre-cut every 33cm for fixing.  
 Wide range of accessories, power supply components and electrical and mechanical connectors.

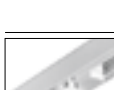
RECESSED 3-PHASE TRACK

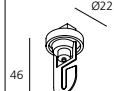
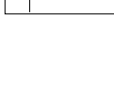
	Standard	DALI
 2000 mm 2,30 kg 3000 mm 3,50 kg 4000 mm 4,60 kg	<b>Code</b> L1726. 2.0	<b>Code</b> L1726. 2.1
 41 59	L1727. 2.0	L1727. 2.1
 44 11 59	L1728. 2.0	L1728. 2.1
 44 11 59	<b>Power supply end cap</b> Earth conductor on left.	L1764. 2.1
 44 11 59	<b>Power supply end cap</b> Earth conductor on right.	L1765. 2.1
 120 15 58	L1764. 2.0	L1764. 2.1
 44	L1765. 2.0	L1765. 2.1
 20 10 25	L1732. 2.0	L1732. 2.1
 20 10 25	L1733. 2.0	L1733. 2.1
 20 10 25	L173400	
 20 10 25	<b>Accessories</b>	
 20 10 25	<b>Standard</b> Code L1720. 2/3 .0	<b>DALI</b> Code L1720. 2/3 .1
 20 10 25	L1722. 2/3 .1	
 20 10 25	L1734. 2/3 .0	

LOAD OF TRACKS WITH SPOTLIGHTS IN RELATION TO FIXING POINTS (INCLUDES THE WEIGHT OF THE TRACK)

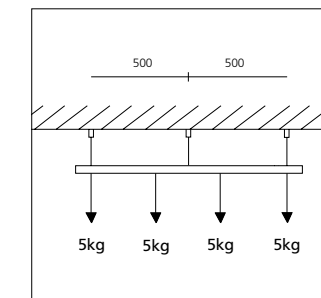

Three-circuit track for pendant mounting with fixing points every 0.5m.  
 (Can also be used for recessed installation).

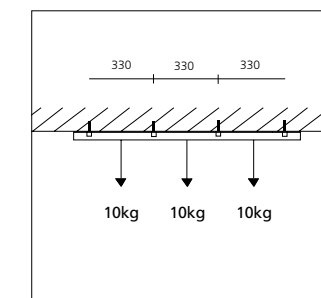

Three-circuit track for ceiling mounting with fixing points every 0.33m.

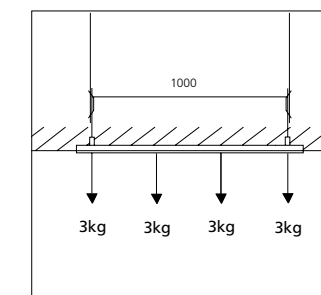

Three-circuit track for recessed installation with fixing points every metre.  
 (Can also be used for pendant mounting).

EARTH CONDUCTOR DIAGRAMS

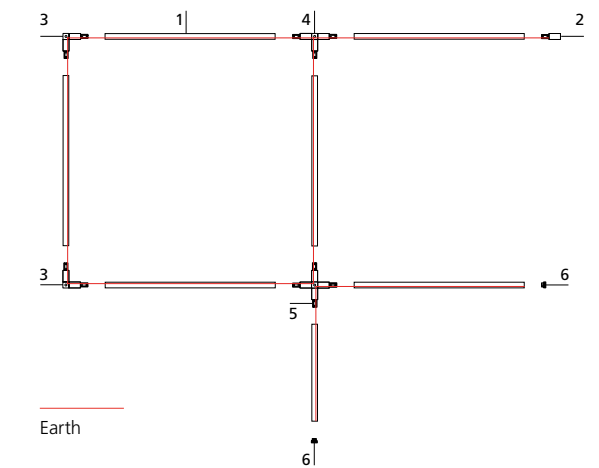

- 1 Standard three-circuit track.
- 2 Power supply end cap, earth conductor on left.
- 3 90° joint, internal earth conductor.
- 4 3-way joint, earth conductor on left.
- 5 4-way joint.
- 6 Closure end cap.

ELECTRICAL DIAGRAM FOR ALTERNATING CURRENT 230V (220-240V)

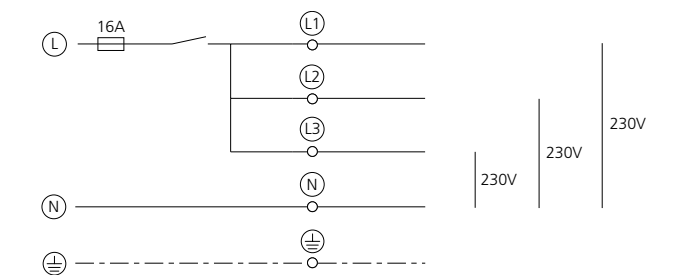

Maximum W allowed: 3600W (max 16A total).  
 The load can be distributed over the 3 circuits as required.  
 Protection fuse: 1x16A.  
 Power supply cable section: min 3x1.5mm<sup>2</sup> - max 3x2.5mm<sup>2</sup>.

# Downlighting

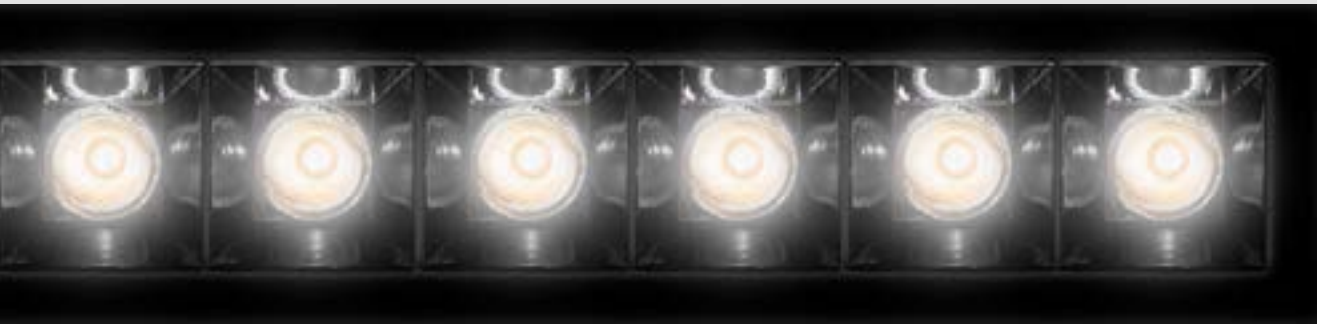
Sharp	202
Everything	226
Una Pro 75	240
Una Pro 150	250
PAD 80	256
Luceri	264
Picto Recessed	278
Parabola	280
Rastaf	286
Zeno Up	290
Zeno Up Frosted	294



# Sharp

Carlotta de Bevilacqua

↪ 2016



A patented high-efficiency optical system combining a polynomial optical unit with geometric screening of the beam's viewing angle.

Highly uniform lighting and full emission control.

Total absence of any lighting defects, such as spots or multiple shadows.

Recess depth 60 mm.

Suited for 1 to 25 mm ceilings.

Available in the trim, trimless and SMD versions.

→ PATENT PENDING



For further information on Sharp  
↪ visit [artemide.com](http://artemide.com)



**Artemide  
App**

↪ on request

Only for recessed version  
(4x, 6x, 12X, 16x)





# Sharp

↳ trim - trimless

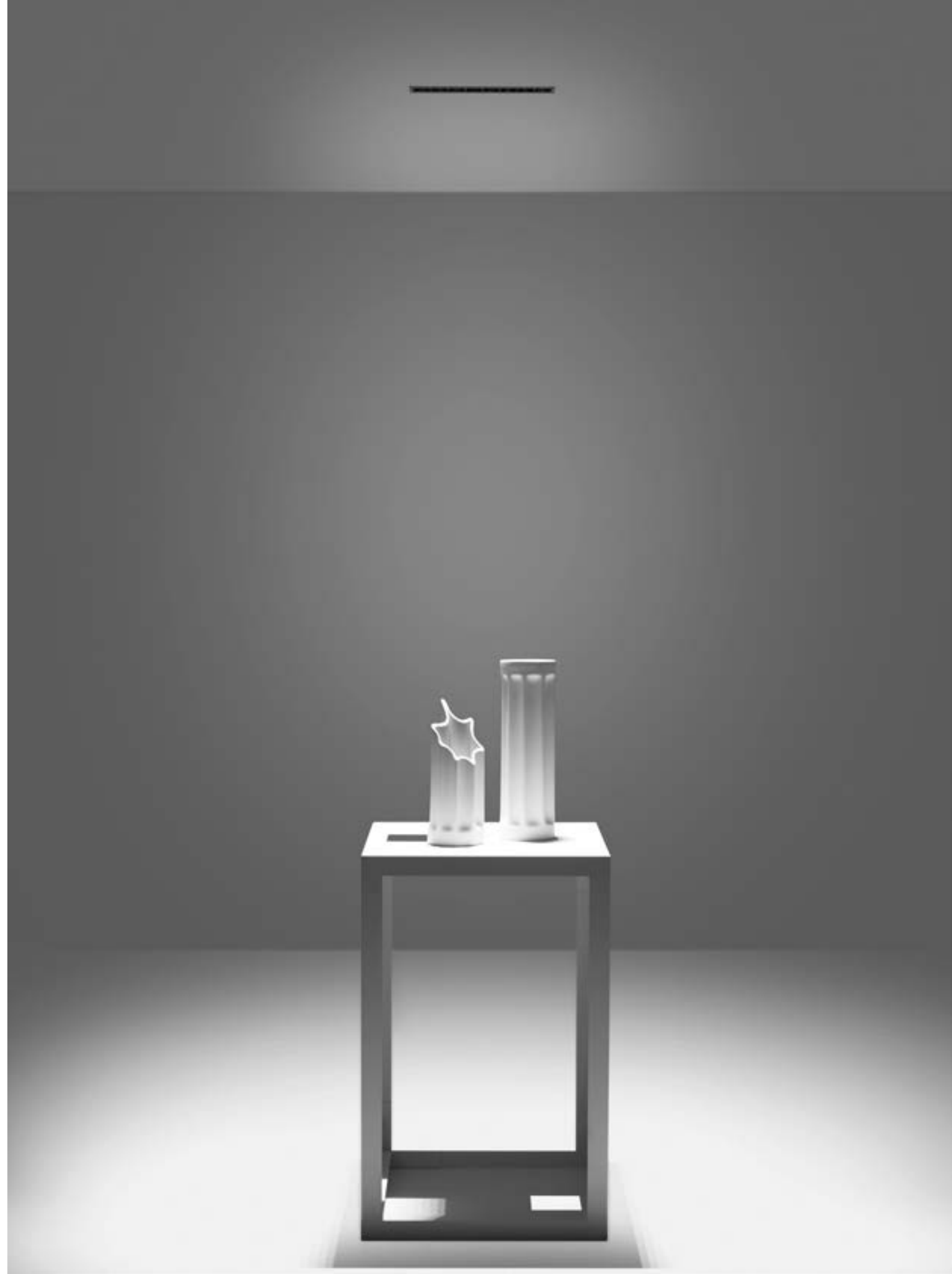
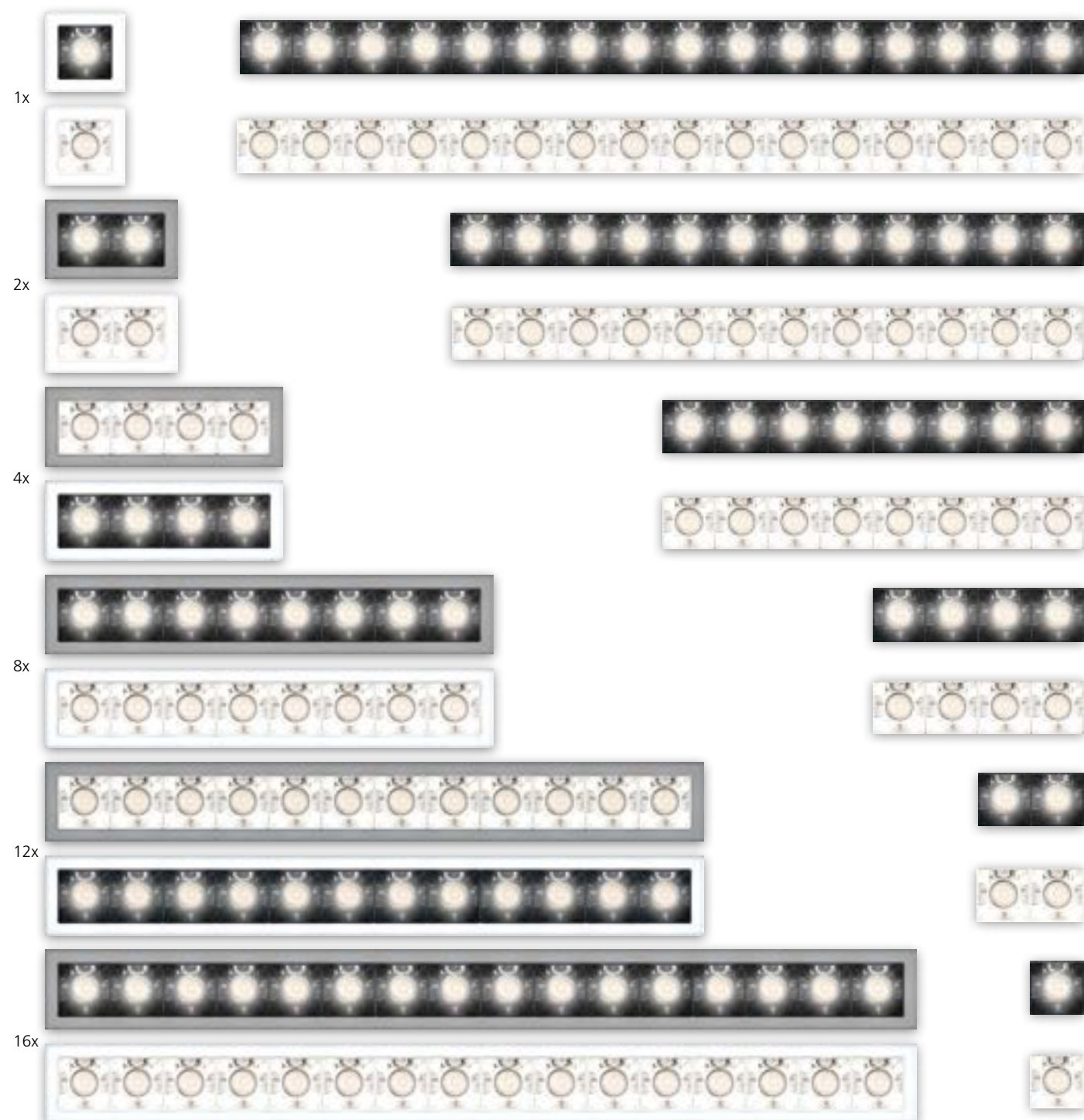

# Sharp trim - trimless typologies



→ Sharp trim

→ Sharp trimless

Minimum distance from  
the wall

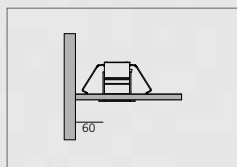

Minimum distance between the devices

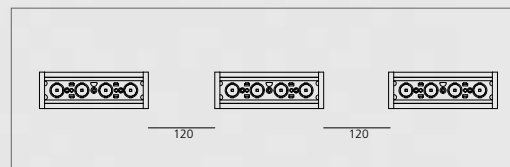

# Sharp trim

Optic unit

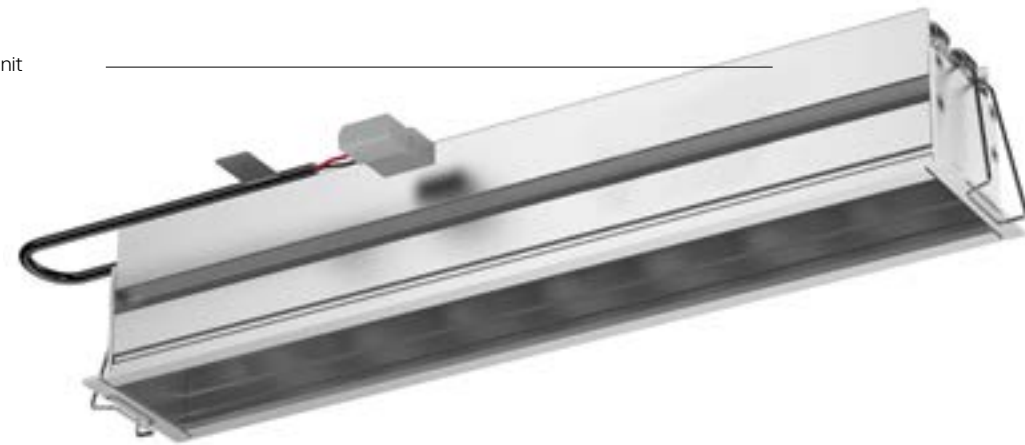

Louvres

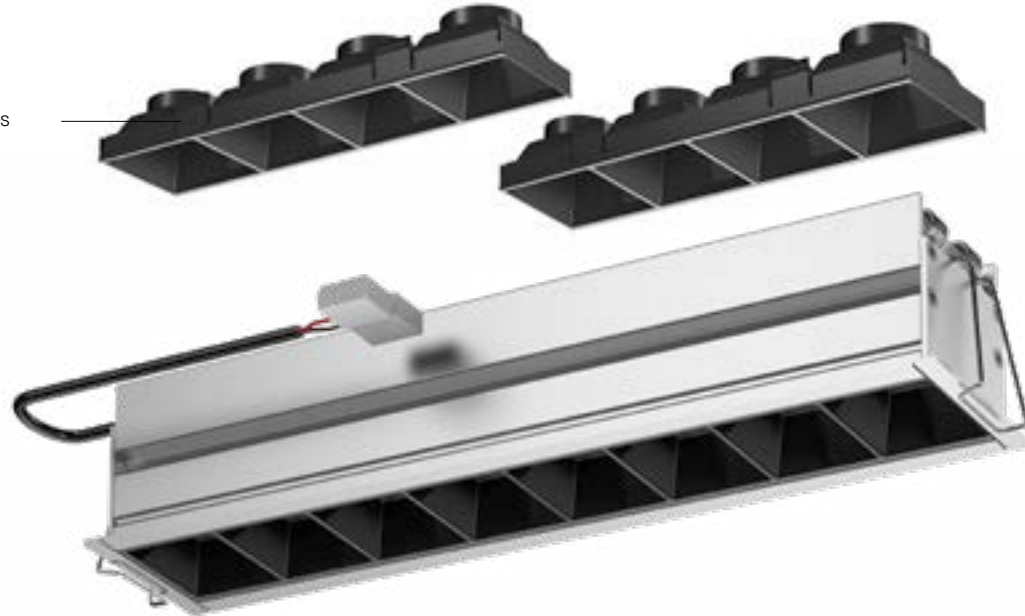

## ↪ SHARP TRIM

White 01    Black 04    Silver 05    S    F    WF    Driver 900mA SELV and louvres supplied separately.    MacAdam 2SDCM Life L90 (17K) 103000h CRI >90    IP20

	Watt	Beam	Flux	CCT	Code
1 optic unit	3 W	S 20°	189 lm	2700 K	<b>AF000.</b> 01/05/04
			201 lm	3000 K	<b>AF003.</b> 01/05/04
			215 lm	4000 K	<b>AF006.</b> 01/05/04
		F 36°	177 lm	2700 K	<b>AF001.</b> 01/05/04
			188 lm	3000 K	<b>AF004.</b> 01/05/04
			201 lm	4000 K	<b>AF007.</b> 01/05/04
		WF 52°	183 lm	2700 K	<b>AF002.</b> 01/05/04
			195 lm	3000 K	<b>AF005.</b> 01/05/04
			208 lm	4000 K	<b>AF008.</b> 01/05/04
2 optic units	5,5 W	S 20°	377 lm	2700 K	<b>AF050.</b> 01/05/04
			402 lm	3000 K	<b>AF053.</b> 01/05/04
			430 lm	4000 K	<b>AF056.</b> 01/05/04
		F 36°	353 lm	2700 K	<b>AF051.</b> 01/05/04
			376 lm	3000 K	<b>AF054.</b> 01/05/04
			403 lm	4000 K	<b>AF057.</b> 01/05/04
		WF 52°	366 lm	2700 K	<b>AF052.</b> 01/05/04
			389 lm	3000 K	<b>AF055.</b> 01/05/04
			417 lm	4000 K	<b>AF058.</b> 01/05/04
4 optic units	11 W	S 20°	755 lm	2700 K	<b>AF100.</b> 01/05/04
			804 lm	3000 K	<b>AF103.</b> 01/05/04
			860 lm	4000 K	<b>AF106.</b> 01/05/04
		F 36°	706 lm	2700 K	<b>AF101.</b> 01/05/04
			752 lm	3000 K	<b>AF104.</b> 01/05/04
			805 lm	4000 K	<b>AF107.</b> 01/05/04
		WF 52°	731 lm	2700 K	<b>AF102.</b> 01/05/04
			779 lm	3000 K	<b>AF105.</b> 01/05/04
			834 lm	4000 K	<b>AF108.</b> 01/05/04
8 optic units	22 W	S 20°	1509 lm	2700 K	<b>AF147.</b> 01/05/04
			1608 lm	3000 K	<b>AF150.</b> 01/05/04
			1721 lm	4000 K	<b>AF153.</b> 01/05/04
		F 36°	1412 lm	2700 K	<b>AF148.</b> 01/05/04
			1504 lm	3000 K	<b>AF151.</b> 01/05/04
			1610 lm	4000 K	<b>AF154.</b> 01/05/04
		WF 52°	1462 lm	2700 K	<b>AF149.</b> 01/05/04
			1558 lm	3000 K	<b>AF152.</b> 01/05/04
			1667 lm	4000 K	<b>AF155.</b> 01/05/04
12 optic units	33 W	S 20°	2263 lm	2700 K	<b>AF197.</b> 01/05/04
			2412 lm	3000 K	<b>AF200.</b> 01/05/04
			2581 lm	4000 K	<b>AF203.</b> 01/05/04
		F 36°	2118 lm	2700 K	<b>AF198.</b> 01/05/04
			2256 lm	3000 K	<b>AF201.</b> 01/05/04
			2415 lm	4000 K	<b>AF204.</b> 01/05/04
		WF 52°	2193 lm	2700 K	<b>AF199.</b> 01/05/04
			2337 lm	3000 K	<b>AF202.</b> 01/05/04
			2501 lm	4000 K	<b>AF205.</b> 01/05/04
16 optic units	44 W	S 20°	3019 lm	2700 K	<b>AF247.</b> 01/05/04
			3215 lm	3000 K	<b>AF250.</b> 01/05/04
			3442 lm	4000 K	<b>AF253.</b> 01/05/04
		F 36°	2824 lm	2700 K	<b>AF248.</b> 01/05/04
			3009 lm	3000 K	<b>AF251.</b> 01/05/04
			3220 lm	4000 K	<b>AF254.</b> 01/05/04
		WF 52°	2924 lm	2700 K	<b>AF249.</b> 01/05/04
			3316 lm	3000 K	<b>AF252.</b> 01/05/04
			3335 lm	4000 K	<b>AF255.</b> 01/05/04

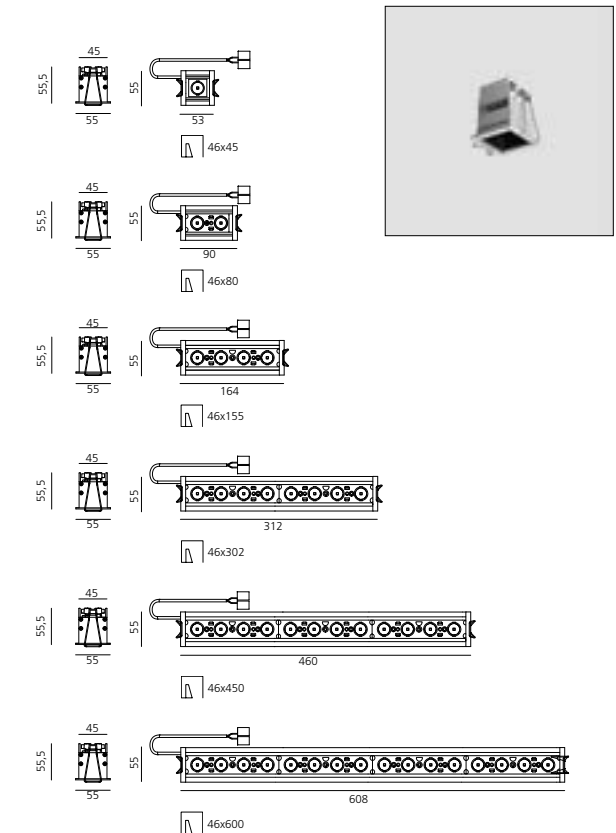

Driver								Code	
Vac	L <sub>mm</sub>	W <sub>mm</sub>	H <sub>mm</sub>	Optic units	Min. ceiling depth (mm)				
7,2 W 900mA	220-240	76	32	22	1x / 2x	80 / 60	Undimmable	<b>DV1001</b>	
19,8 W 900mA	220-240	125	38	23	4x	60	Undimmable	<b>DV1002</b>	
20 W 900mA	220-240	180	32	32	4x	80	DALI	<b>DV1008</b>	
32 W 1000mA	220-240	129,5	42	30	8x	80	Undimmable	<b>DV1004</b>	
50 W 1050mA	220-240	124	79	22	12x / 16x	80	Undimmable	<b>DV1005</b>	
40 W 900mA	220-240	97	43	30	8x / 16x	80	Undimmable	<b>DV1006</b>	
25 W 900mA	220-240	164	38	24,5	1x / 2x / 4x / 8x	150 / 130 / 80 / 60	DALI	<b>DV1003</b>	
48 W 900mA	220-240	110	75	25,7	12x / 16x	80 / 80	DALI	<b>DV1007</b>	

Louvres		Code
	1X	<b>AF950.</b> 01/04
	2X	<b>AF951.</b> 01/04
	4X	<b>AF952.</b> 01/04

Accessories		Code
	Sharpening wall grazer lens Kit (4pcs) 26°x70° elliptical lenses kit. It has to be used on top of S 20° reflectors to get an elliptical beam (greater axis along the module length). It contains 4 lenses.	<b>AF06000</b>

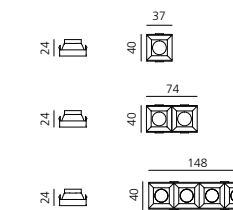

# Sharp trimless

## ↳ SHARP TRIMLESS

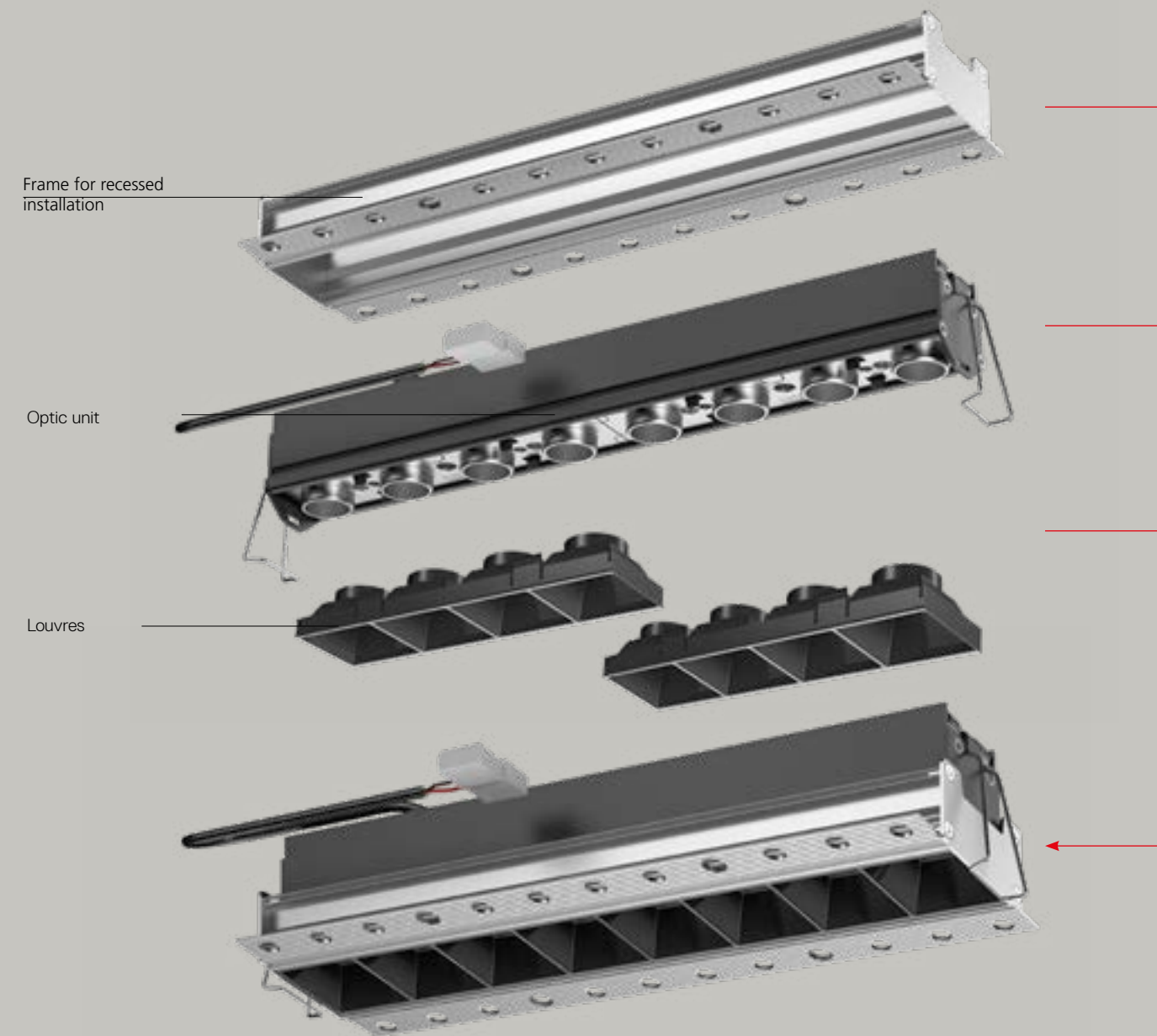

Frame for recessed installation

Optic unit

Louvres



Driver 900mA SELV and louvres supplied separately.

MacAdam 2SDCM  
Life L90 (17K) 103000h  
CRI >90

	Watt	Beam	Flux	CCT	Code		
1 optic unit	3 W	S 20°	189 lm	2700 K	<b>AF50000</b>		
			201 lm	3000 K	<b>AF50300</b>		
			215 lm	4000 K	<b>AF50600</b>		
		F 36°	177 lm	2700 K	<b>AF50100</b>		
			188 lm	3000 K	<b>AF50400</b>		
			201 lm	4000 K	<b>AF50700</b>		
		WF 52°	183 lm	2700 K	<b>AF50200</b>		
			195 lm	3000 K	<b>AF50500</b>		
			208 lm	4000 K	<b>AF50800</b>		
2 optic units	5,5 W	S 20°	371 lm	2700 K	<b>AF55000</b>		
			402 lm	3000 K	<b>AF55300</b>		
			430 lm	4000 K	<b>AF55600</b>		
		F 36°	353 lm	2700 K	<b>AF55100</b>		
			376 lm	3000 K	<b>AF55400</b>		
			403 lm	4000 K	<b>AF55700</b>		
	WF 52°	366 lm	2700 K	<b>AF55200</b>			
		389 lm	3000 K	<b>AF55500</b>			
		417 lm	4000 K	<b>AF55800</b>			
		4 optic units	11 W	S 20°	755 lm	2700 K	<b>AF60000</b>
					804 lm	3000 K	<b>AF60300</b>
					860 lm	4000 K	<b>AF60600</b>
F 36°	706 lm		2700 K	<b>AF60100</b>			
	752 lm		3000 K	<b>AF60400</b>			
	805 lm		4000 K	<b>AF60700</b>			
WF 52°	731 lm	2700 K	<b>AF60200</b>				
	779 lm	3000 K	<b>AF60500</b>				
	834 lm	4000 K	<b>AF60800</b>				
	8 optic units	22 W	S 20°	1509 lm	2700 K	<b>AF64700</b>	
				1608 lm	3000 K	<b>AF65000</b>	
				1721 lm	4000 K	<b>AF65300</b>	
F 36°			11412 lm	2700 K	<b>AF64800</b>		
			1504 lm	3000 K	<b>AF65100</b>		
			1610 lm	4000 K	<b>AF65400</b>		
WF 52°		1462 lm	2700 K	<b>AF64900</b>			
		1558 lm	3000 K	<b>AF65200</b>			
		1667 lm	4000 K	<b>AF65500</b>			
		12 optic units	33 W	S 20°	2263 lm	2700 K	<b>AF69700</b>
					2412 lm	3000 K	<b>AF70000</b>
					2581 lm	4000 K	<b>AF70300</b>
F 36°	2118 lm			2700 K	<b>AF69800</b>		
	2256 lm			3000 K	<b>AF70100</b>		
	2415 lm			4000 K	<b>AF70400</b>		
WF 52°	2193 lm		2700 K	<b>AF69900</b>			
	2337 lm		3000 K	<b>AF70200</b>			
	2501 lm		4000 K	<b>AF70500</b>			
	16 optic units		44 W	S 20°	3019 lm	2700 K	<b>AF74700</b>
					3215 lm	3000 K	<b>AF75000</b>
					3442 lm	4000 K	<b>AF75300</b>
F 36°		2824 lm		2700 K	<b>AF74800</b>		
		3009 lm		3000 K	<b>AF75100</b>		
		3220 lm		4000 K	<b>AF75400</b>		
WF 52°		2924 lm	2700 K	<b>AF74900</b>			
		3316 lm	3000 K	<b>AF75200</b>			
		3335 lm	4000 K	<b>AF75500</b>			

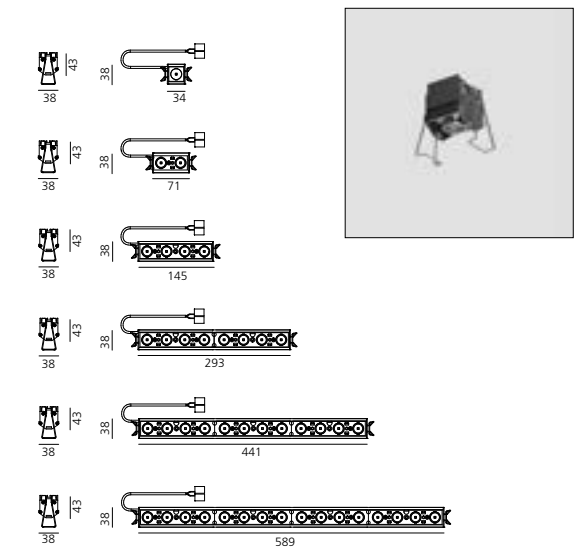

## ↳ SHARP TRIMLESS

White Black



Driver 900mA SELV and louvres supplied separately.

### Frame for recessed installation



1X  
2X  
4X  
8X  
12X  
16X

#### Code

**AF90000**  
**AF90100**  
**AF90200**  
**AF90300**  
**AF90400**  
**AF90500**

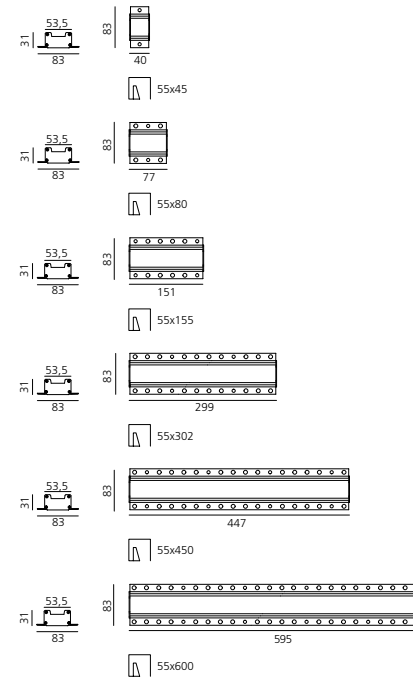

### Louvres



1X  
2X  
4X

#### Code

**AF950. 01/04**  
**AF951. 01/04**  
**AF952. 01/04**

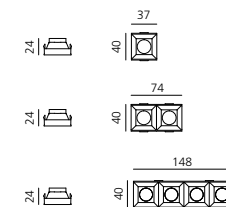

### Accessories



**Sharping wall grazer lens Kit (4pcs)**  
26°x70° elliptical lenses kit. It has to be used on top of S 20° reflectors to get an elliptical beam (greater axis along the module length). It contains 4 lenses.

#### Code

**AF06000**

### Driver

	Vac	L <sub>mm</sub>	W <sub>mm</sub>	H <sub>mm</sub>	Optic units	Min. ceiling depth (mm)		Code
7,2 W 900mA	220-240	76	32	22	1x / 2x	80 / 60	Undimmable	<b>DV1001</b>
19,8 W 900mA	220-240	125	38	23	4x	60	Undimmable	<b>DV1002</b>
20 W 900mA	220-240	180	32	32	4x	80	DALI	<b>DV1008</b>
32 W 1000mA	220-240	129,5	42	30	8x	80	Undimmable	<b>DV1004</b>
50 W 1050mA	220-240	124	79	22	12x / 16x	80	Undimmable	<b>DV1005</b>
40 W 900mA	220-240	97	43	30	8x / 16x	80	Undimmable	<b>DV1006</b>
25 W 900mA	220-240	164	38	24,5	1x / 2x / 4x / 8x	150 / 130 / 80 / 60	DALI	<b>DV1003</b>
48 W 900mA	220-240	110	75	25,7	12x / 16x	80 / 80	DALI	<b>DV1007</b>

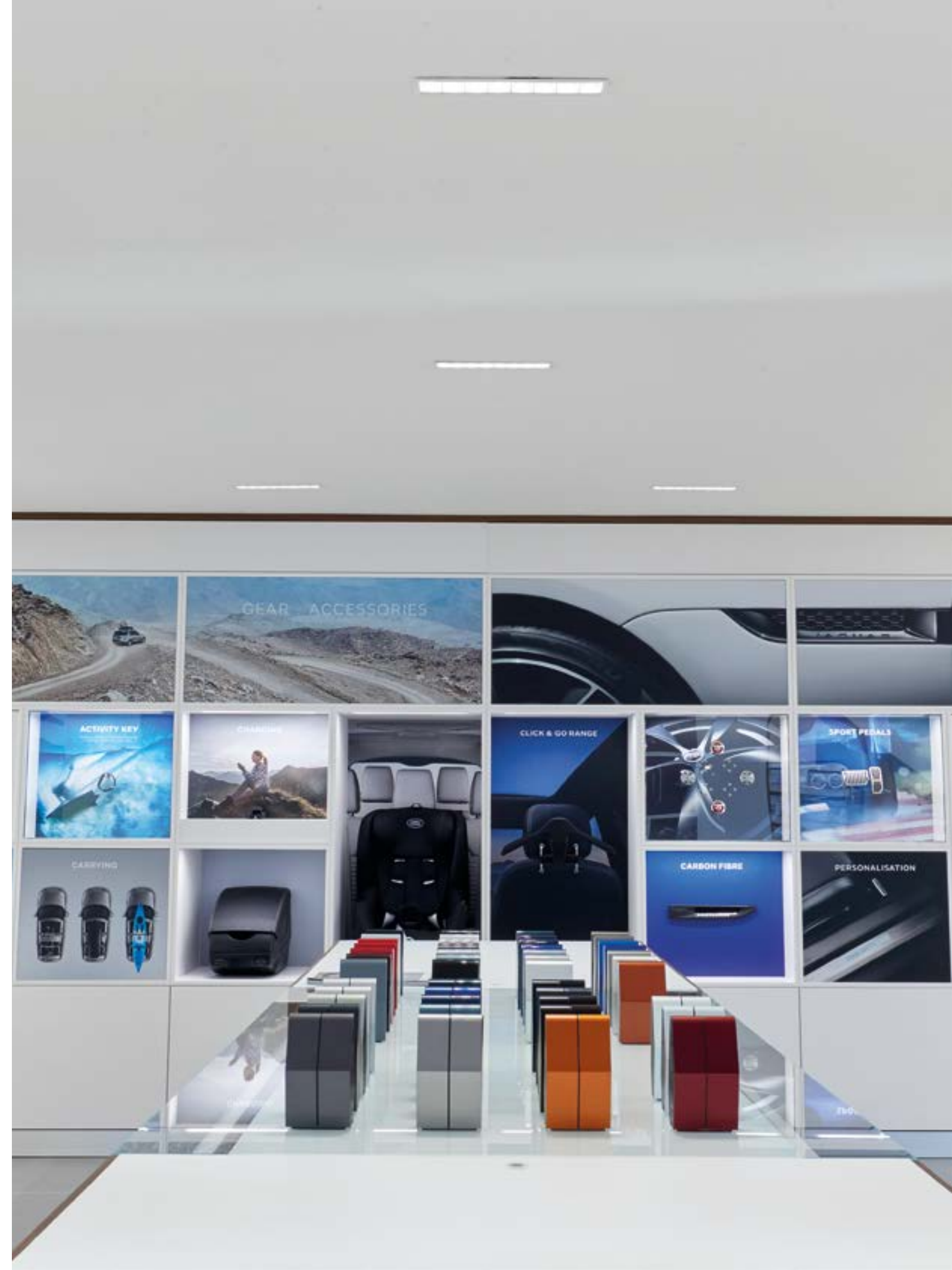

# Sharp wall washer

## SHARP TRIM WALL WASHER

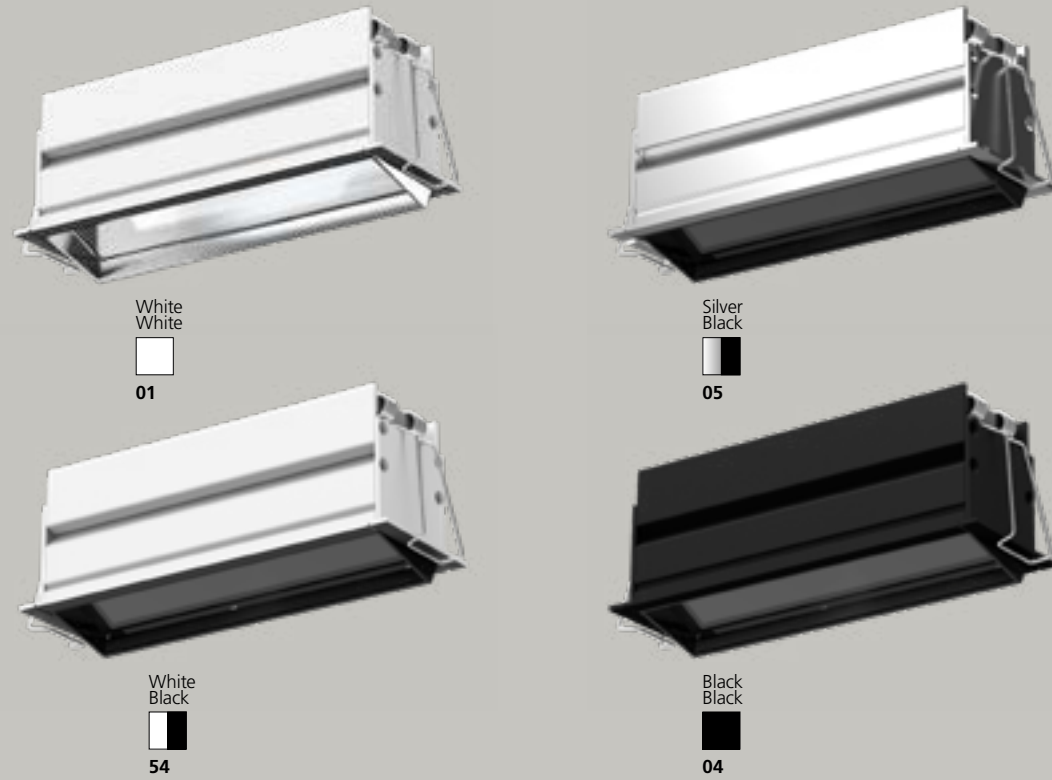

## SHARP TRIMLESS WALL WASHER

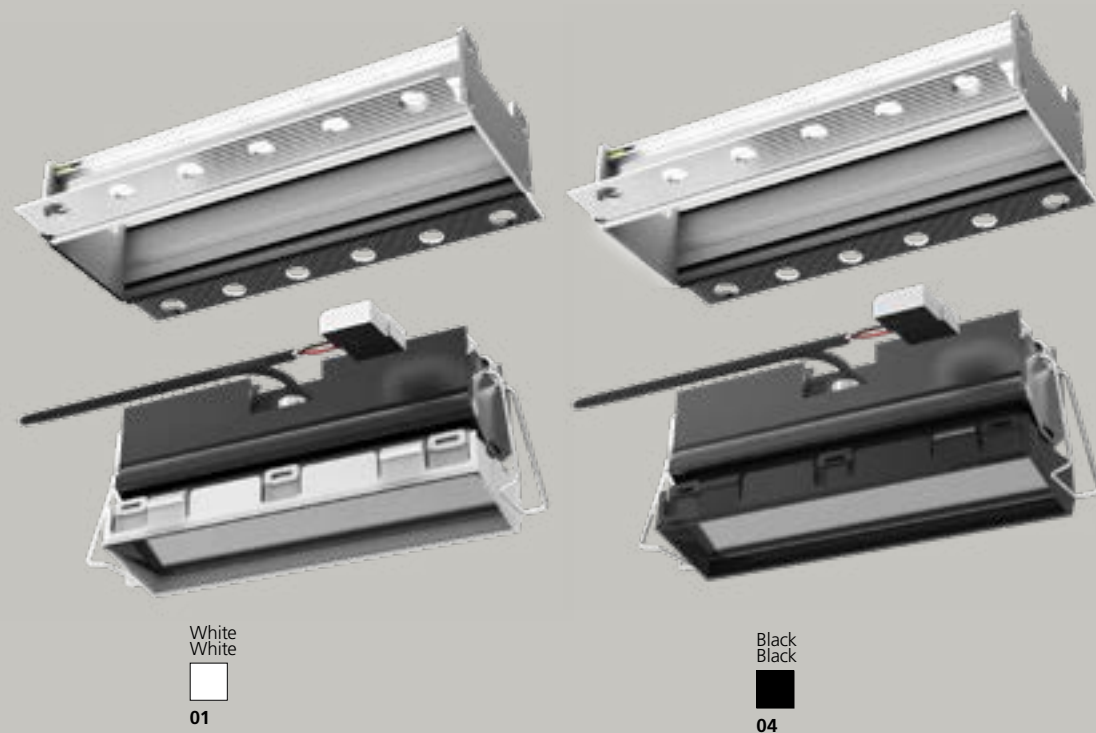

## SHARP TRIM - TRIMLESS WALL WASHER

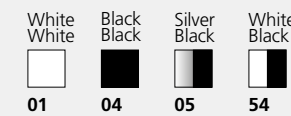

Driver 900mA SELV a supplied separately.  
Louvres included.

MacAdam 2SDCM  
Life L90 (17K) 103000h  
CRI >90

### TRIM

	W	Flux	CCT	Code
1 optic unit	12 W	657 lm	2700 K	<b>AF109.</b> 01/04/05/54
		657 lm	3000 K	<b>AF110.</b> 01/04/05/54
		657 lm	4000 K	<b>AF111.</b> 01/04/05/54
2 optic units	22 W	1314 lm	2700 K	<b>AF156.</b> 01/04/05/54
		1314 lm	3000 K	<b>AF157.</b> 01/04/05/54
		1314 lm	4000 K	<b>AF158.</b> 01/04/05/54
3 optic units	33 W	1971 lm	2700 K	<b>AF206.</b> 01/04/05/54
		1971 lm	3000 K	<b>AF207.</b> 01/04/05/54
		1971 lm	4000 K	<b>AF208.</b> 01/04/05/54
4 optic units	44 W	2628 lm	2700 K	<b>AF256.</b> 01/04/05/54
		2628 lm	3000 K	<b>AF257.</b> 01/04/05/54
		2628 lm	4000 K	<b>AF258.</b> 01/04/05/54

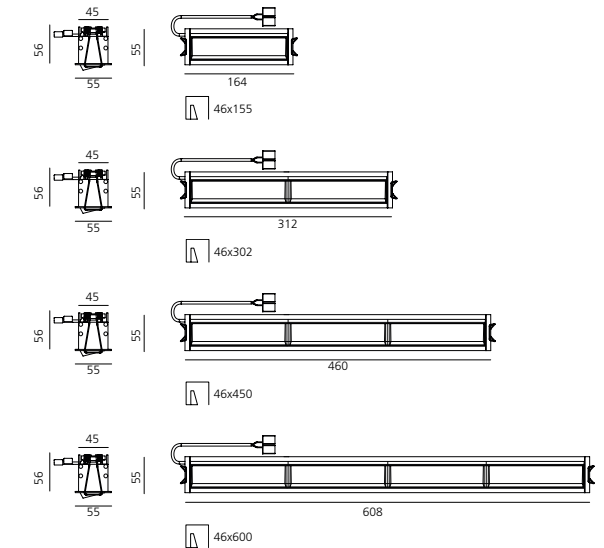

### TRIMLESS

	W	Flux	CCT	Code
1 optic unit	12 W	657 lm	2700 K	<b>AF609.</b> 01/04
		657 lm	3000 K	<b>AF610.</b> 01/04
		657 lm	4000 K	<b>AF611.</b> 01/04
2 optic units	22 W	1314 lm	2700 K	<b>AF656.</b> 01/04
		1314 lm	3000 K	<b>AF657.</b> 01/04
		1314 lm	4000 K	<b>AF658.</b> 01/04
3 optic units	33 W	1971 lm	2700 K	<b>AF706.</b> 01/04
		1971 lm	3000 K	<b>AF707.</b> 01/04
		1971 lm	4000 K	<b>AF708.</b> 01/04
4 optic units	44 W	2628 lm	2700 K	<b>AF756.</b> 01/04
		2628 lm	3000 K	<b>AF757.</b> 01/04
		2628 lm	4000 K	<b>AF758.</b> 01/04

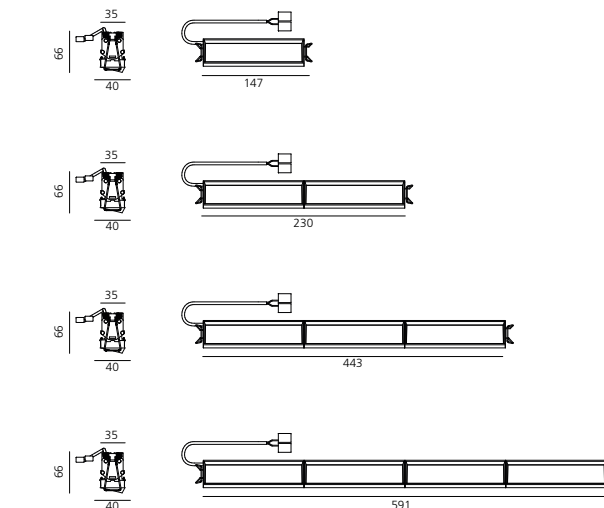

### Frame for recessed installation



	Code
1X	<b>AF90200</b>
2X	<b>AF90300</b>
3X	<b>AF90400</b>
4X	<b>AF90500</b>

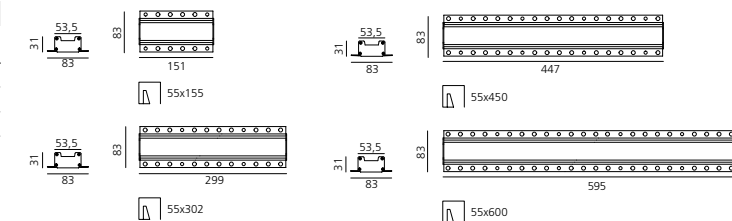

Driver	Vac	L <sub>mm</sub>	W <sub>mm</sub>	H <sub>mm</sub>	Optic units	Min. ceiling depth (mm)		Code
19,8 W 900mA	220-240	125	38	23	1x	60	Undimmable	<b>DV1002</b>
20 W 900mA	220-240	180	32	32	1x	80	DALI	<b>DV1008</b>
32 W 1000mA	220-240	129,5	42	30	2x	80	Undimmable	<b>DV1004</b>
50 W 1050mA	220-240	124	79	22	3x / 4x	80	Undimmable	<b>DV1005</b>
40 W 900mA	220-240	97	43	30	2x / 4x	80	Undimmable	<b>DV1006</b>
25 W 900mA	220-240	164	38	24,5	1x / 2x	80 / 60	DALI	<b>DV1003</b>
48 W 900mA	220-240	110	75	25,7	3x / 4x	80 / 80	DALI	<b>DV1007</b>

# Sharp ↪ SMD





# Sharp SMD

## 1x - 2x - 4x



### SHARP SMD

White 01    Black 04    Silver 05    S    F    WF    Driver 24Vdc Selv and louvres supplied separately.    MacAdam 2SDCM Life L90 (17K) 103000h CRI >90    IP20

	Watt	Beam	Flux	CCT	Code	
1 optic unit	3,5 W	S 20°	189 lm	2700 K	<b>AF310.</b> 01/04/05	
			201 lm	3000 K	<b>AF313.</b> 01/04/05	
			215 lm	4000 K	<b>AF316.</b> 01/04/05	
	F 36°		177 lm	2700 K	<b>AF311.</b> 01/04/05	
			188 lm	3000 K	<b>AF314.</b> 01/04/05	
			201 lm	4000 K	<b>AF317.</b> 01/04/05	
	WF 52°		183 lm	2700 K	<b>AF312.</b> 01/04/05	
			195 lm	3000 K	<b>AF315.</b> 01/04/05	
			208 lm	4000 K	<b>AF318.</b> 01/04/05	
2 optic units	6,5 W	S 20°	377 lm	2700 K	<b>AF360.</b> 01/04/05	
			402 lm	3000 K	<b>AF363.</b> 01/04/05	
			430 lm	4000 K	<b>AF366.</b> 01/04/05	
		F 36°	353 lm	2700 K	<b>AF361.</b> 01/04/05	
			376 lm	3000 K	<b>AF364.</b> 01/04/05	
			403 lm	4000 K	<b>AF367.</b> 01/04/05	
	WF 52°	366 lm	2700 K	<b>AF362.</b> 01/04/05		
		389 lm	3000 K	<b>AF365.</b> 01/04/05		
		417 lm	4000 K	<b>AF368.</b> 01/04/05		
	4 optic units	12 W	S 20°	755 lm	2700 K	<b>AF410.</b> 01/04/05
				804 lm	3000 K	<b>AF413.</b> 01/04/05
				860 lm	4000 K	<b>AF416.</b> 01/04/05
F 36°			706 lm	2700 K	<b>AF411.</b> 01/04/05	
			752 lm	3000 K	<b>AF414.</b> 01/04/05	
			805 lm	4000 K	<b>AF417.</b> 01/04/05	
WF 52°	731 lm	2700 K	<b>AF412.</b> 01/04/05			
	779 lm	3000 K	<b>AF415.</b> 01/04/05			
	834 lm	4000 K	<b>AF418.</b> 01/04/05			

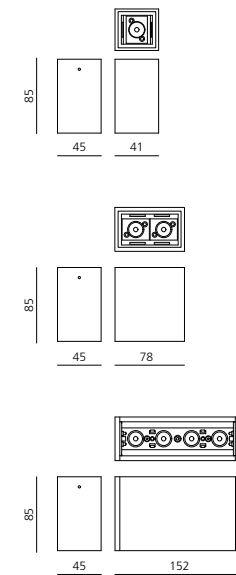
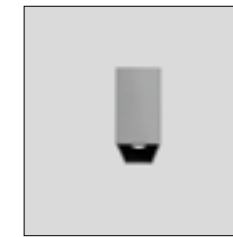

#### Louvres

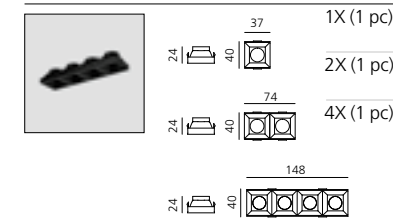

#### Code

**AF950.** 01/04  
**AF951.** 01/04  
**AF952.** 01/04

#### Accessories

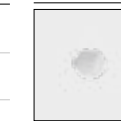

**Sharping wall grazer lens Kit (4pcs)**  
26°x70° elliptical lenses kit. It has to be used on top of S 20° reflectors to get an elliptical beam (greater axis along the module length). It contains 4 lenses.

#### Code

**AF06000**

Driver	W	Vin (V)	Vout (V)	L mm	W mm	H mm	W max	Min wire section mm <sup>2</sup>	Max wire length m	n°device			Dimming			Code
										1x	2x	4x	DALI	1-10V	PUSH	
CV Selv	30	220-240 Vac	24Vdc	153	41	32	25	1.5	30	7	4	2	no	no	no	<b>DV1032</b>
CV Selv	75	220-240 Vac	24Vdc	180	52	30	63	1.5	30	18	10	5	no	no	no	<b>DV1009</b>
CV Selv	120	220-240 Vac	24Vdc	300	40	30	102	1.5	30	29	16	8	no	no	no	<b>DV1033</b>
Dimmer	NA	24Vdc	24Vdc PWM	80	54	24	max 100	1.5	30	see above			yes	yes	yes	<b>DV1048</b>

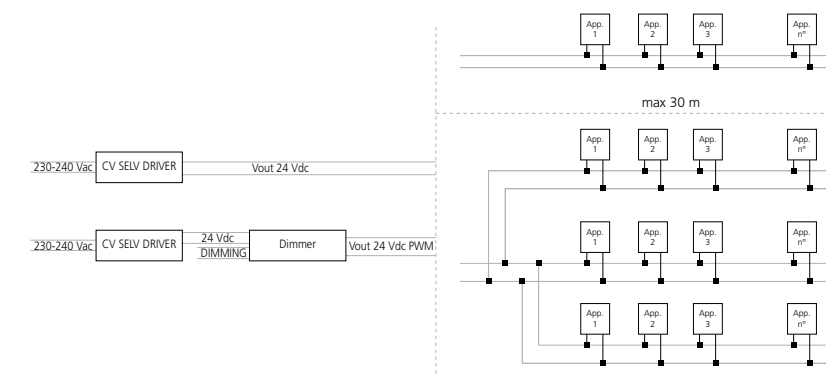

appliances number: see table

# Sharp SMD

## 8x - 12x - 16x

White	Black	Silver	S	F	WF	MacAdam 2SDCM	IP20
01	04	05				Life L90 (17K) 103000h	
						CRI >90	

	Watt	Beam	Flux	CCT	Undimmable		Dimmable DALI	
					Code	Code		
8 optic units	24 W	S 20°	1509 lm	2700 K	<b>AF457.</b>	01/04/05	<b>AF476.</b>	01/04/05
			1608 lm	3000 K	<b>AF460.</b>	01/04/05	<b>AF470.</b>	01/04/05
			1721 lm	4000 K	<b>AF463.</b>	01/04/05	<b>AF473.</b>	01/04/05
		F 36°	1412 lm	2700 K	<b>AF458.</b>	01/04/05	<b>AF477.</b>	01/04/05
			1504 lm	3000 K	<b>AF461.</b>	01/04/05	<b>AF471.</b>	01/04/05
			1610 lm	4000 K	<b>AF464.</b>	01/04/05	<b>AF474.</b>	01/04/05
		WF 52°	1462 lm	2700 K	<b>AF459.</b>	01/04/05	<b>AF478.</b>	01/04/05
			1558 lm	3000 K	<b>AF462.</b>	01/04/05	<b>AF472.</b>	01/04/05
			1667 lm	4000 K	<b>AF465.</b>	01/04/05	<b>AF475.</b>	01/04/05
12 optic units	37 W	S 20°	2263 lm	2700 K	<b>AF807.</b>	01/04/05	<b>AF826.</b>	01/04/05
			2412 lm	3000 K	<b>AF810.</b>	01/04/05	<b>AF820.</b>	01/04/05
			2581 lm	4000 K	<b>AF813.</b>	01/04/05	<b>AF823.</b>	01/04/05
		F 36°	2118 lm	2700 K	<b>AF808.</b>	01/04/05	<b>AF827.</b>	01/04/05
			2256 lm	3000 K	<b>AF811.</b>	01/04/05	<b>AF821.</b>	01/04/05
			2415 lm	4000 K	<b>AF814.</b>	01/04/05	<b>AF824.</b>	01/04/05
		WF 52°	2193 lm	2700 K	<b>AF809.</b>	01/04/05	<b>AF828.</b>	01/04/05
			2337 lm	3000 K	<b>AF812.</b>	01/04/05	<b>AF822.</b>	01/04/05
			2501 lm	4000 K	<b>AF815.</b>	01/04/05	<b>AF825.</b>	01/04/05
16 optic units	47 W	S 20°	3018 lm	2700 K	<b>AF857.</b>	01/04/05	<b>AF876.</b>	01/04/05
			3215 lm	3000 K	<b>AF860.</b>	01/04/05	<b>AF870.</b>	01/04/05
			3442 lm	4000 K	<b>AF863.</b>	01/04/05	<b>AF873.</b>	01/04/05
		F 36°	2824 lm	2700 K	<b>AF858.</b>	01/04/05	<b>AF877.</b>	01/04/05
			3009 lm	3000 K	<b>AF861.</b>	01/04/05	<b>AF871.</b>	01/04/05
			3220 lm	4000 K	<b>AF864.</b>	01/04/05	<b>AF874.</b>	01/04/05
		WF 52°	2924 lm	2700 K	<b>AF859.</b>	01/04/05	<b>AF878.</b>	01/04/05
			3316 lm	3000 K	<b>AF862.</b>	01/04/05	<b>AF872.</b>	01/04/05
			3335 lm	4000 K	<b>AF865.</b>	01/04/05	<b>AF875.</b>	01/04/05

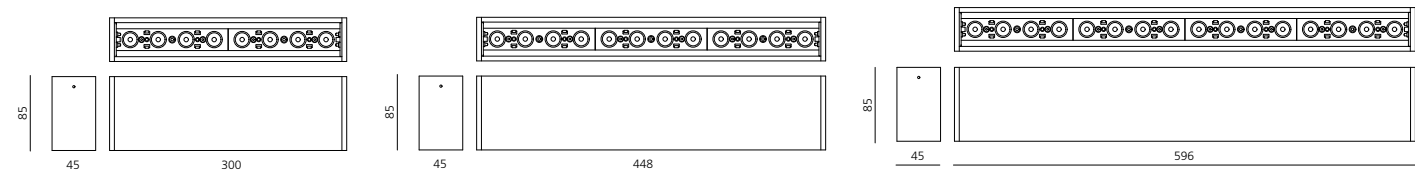
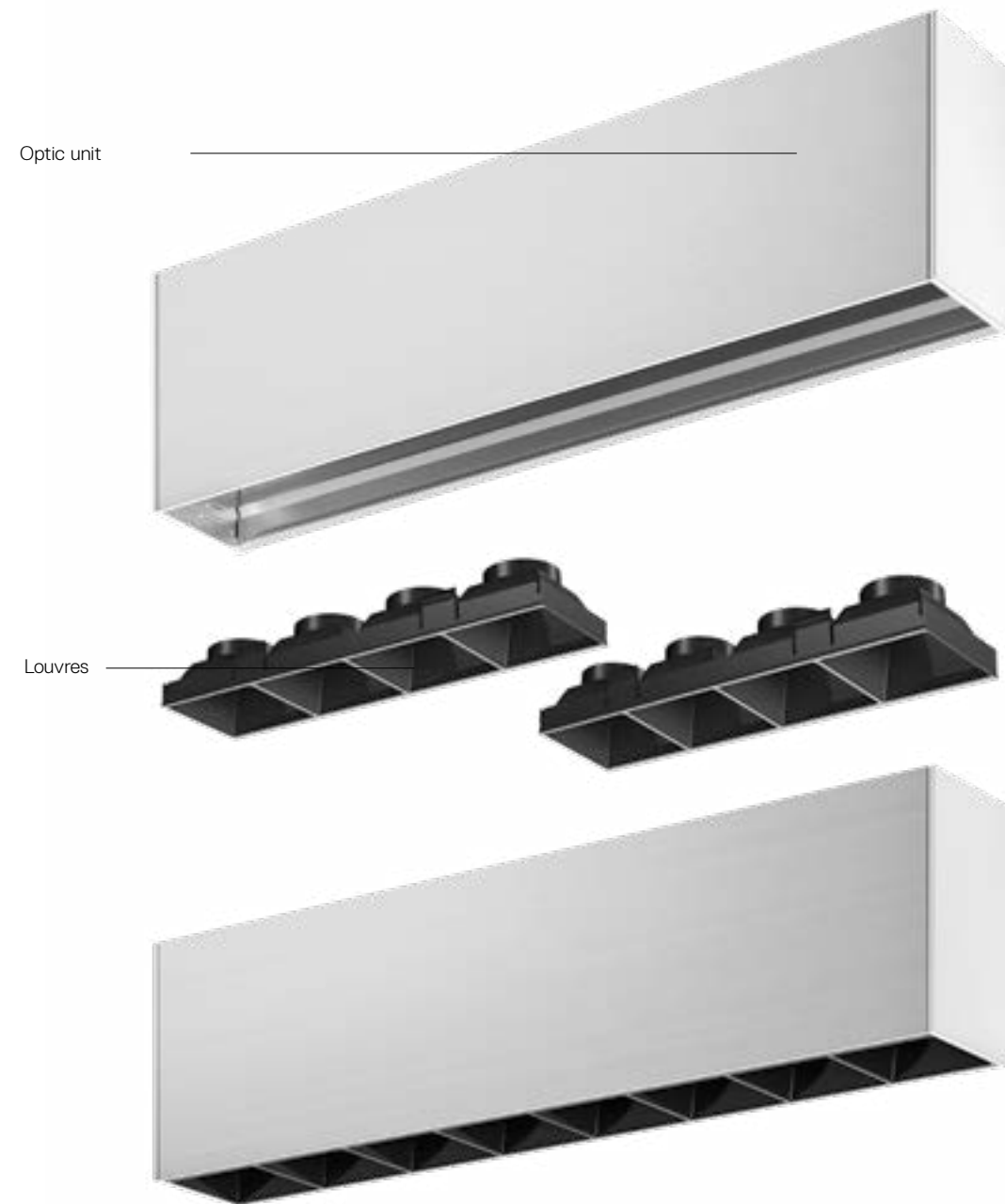
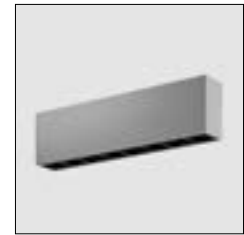

**Louvres**

148

4X (1pc)

Code

**AF952.** 01/04

**Accessories**

Sharpening wall grazer lens Kit (4pcs)

26°x70° elliptical lenses kit. It has to be used on top of S 20° reflectors to get an elliptical beam (greater axis along the module length). It contains 4 lenses.

Code

**AF06000**

# Sharp SMD wall washer



White White  
01



Silver Black  
05



White Black  
54



Black Black  
04

## ↳ SHARP SMD WALL WASHER

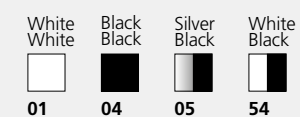

MacAdam 2SDCM IP20  
Life L90 (17K) 103000h  
CRI >90

Driver 24Vdc Selv a supplied separately.

1 optic unit	W	Flux	CCT	Code
	12 W	657 lm	2700 K	<b>AF419.</b> 01/04/05/54
		657 lm	3000 K	<b>AF420.</b> 01/04/05/54
		657 lm	4000 K	<b>AF421.</b> 01/04/05/54

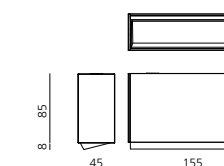

Driver	W	Vin (V)	Vout (V)	L mm	W mm	H mm	W max	Min Wire section mm <sup>2</sup>	Max wire lenght m	n°device	Dimming	Code
CV Selv	30	220-240 Vac	24Vdc	153	41	32	25	1.5	30	2	DALI 1-10V PUSH 0-10V potentiom.	<b>DV1032</b>
CV Selv	75	220-240 Vac	24Vdc	180	52	30	63	1.5	30	3	no no no	<b>DV1009</b>
CV Selv	120	220-240 Vac	24Vdc	300	40	30	102	1.5	30	4	no no no	<b>DV1033</b>
Dimmer	NA	24Vdc	24Vdc PWM	80	54	24	max 100	1.5	30	see above	yes yes yes	<b>DV1048</b>

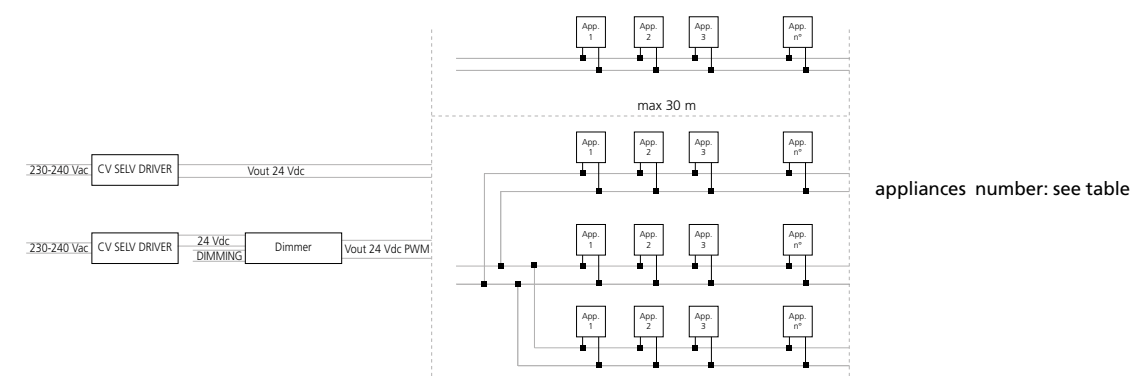

Electronic ballast included.				Undimmable	Dimmable DALI
2 optic units	W	Flux	CCT	Code	Code
	22 W	1314 lm	2700 K	<b>AF466.</b> 01/04/05/54	<b>AF479.</b> 01/04/05/54
		1314 lm	3000 K	<b>AF467.</b> 01/04/05/54	<b>AF480.</b> 01/04/05/54
		1314 lm	4000 K	<b>AF468.</b> 01/04/05/54	<b>AF481.</b> 01/04/05/54
3 optic units	33 W	1971 lm	2700 K	<b>AF816.</b> 01/04/05/54	<b>AF829.</b> 01/04/05/54
		1971 lm	3000 K	<b>AF817.</b> 01/04/05/54	<b>AF830.</b> 01/04/05/54
		1971 lm	4000 K	<b>AF818.</b> 01/04/05/54	<b>AF831.</b> 01/04/05/54
4 optic units	44 W	2628 lm	2700 K	<b>AF866.</b> 01/04/05/54	<b>AF880.</b> 01/04/05/54
		2628 lm	3000 K	<b>AF867.</b> 01/04/05/54	<b>AF881.</b> 01/04/05/54
		2628 lm	4000 K	<b>AF868.</b> 01/04/05/54	<b>AF882.</b> 01/04/05/54

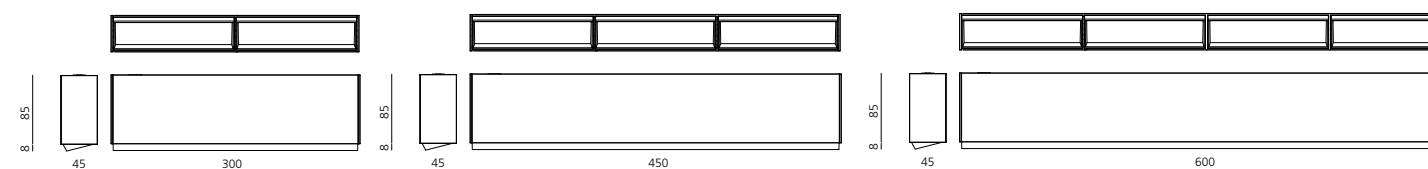



EVERYTHING 35  
ROUND-SQUARE

EVERYTHING 55  
ROUND-SQUARE

EVERYTHING 80  
ROUND-SQUARE

EVERYTHING 105  
ROUND-SQUARE

EVERYTHING 150  
ROUND-SQUARE

# Everything

Ernesto Gismondi  
↪ 2013

EVERYTHING 35  
ROUND-SQUARE

EVERYTHING 55  
ROUND-SQUARE

EVERYTHING 80  
ROUND-SQUARE

EVERYTHING 105  
ROUND-SQUARE

EVERYTHING 150  
ROUND-SQUARE



# Everything typologies



For further information on Everything  
 ↪ visit [artemide.com](http://artemide.com)



**Artemide  
App**

↪ on request  
 Only for 105/150 version

5 dimensions: 35 mm, 55 mm, 80 mm,  
 105 mm, 150 mm.

Different options available: fixed or adjustable  
 (excluding Everything 35), round or square, trim or  
 trimless.

LED versions use an optical system based on a hybrid  
 technology (lens and reflector) producing defined  
 beams with high-power LEDs.

The extruded aluminium heat sink guarantees great  
 thermal management, long life and high efficiency,  
 while providing maximum luminous flux.

Adjustable versions (excluding Everything 80 option)  
 are equipped with a blocking system to guarantee  
 perfect framing.

Rotation up to 360°, beam angle +30°/-30°.

Separate electronic driver: non-dimmable or DALI  
 dimmable options for LED products.

Compliant with standard EN60598-1 and other  
 specific regulations.



↪ EVERYTHING 35

White Black Silver S F Driver 500 mA SELV supplied separately. MacAdam 3SDCM Life L80 (13K) 78600h CRI=90 IP20

Round						Code
W	Weight	Beam	Flux	CCT	Color	
1,4 W	0,10 kg	S 14°	70 lm	2700 K	○	NL4203010Y006
				3000 K	●	NL4203010Y004
				3000 K	●	NL4203010Y002
			98 lm	2700 K	○	NL4203010K006
				3000 K	●	NL4203010K004
				3000 K	●	NL4203010K002
		F 24°	70 lm	2700 K	○	NL4203025Y006
				3000 K	●	NL4203025Y004
				3000 K	●	NL4203025Y002
			98 lm	2700 K	○	NL4203025K006
				3000 K	●	NL4203025K004
				3000 K	●	NL4203025K002

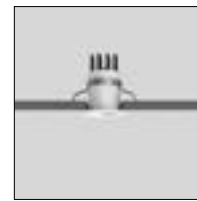

∅ 29 mm

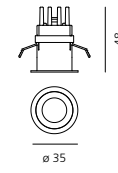

Square						Code
W	Weight	Beam	Flux	CCT	Color	
1,4 W	0,10 kg	S 14°	70 lm	2700 K	○	NL4203110Y006
				3000 K	●	NL4203110Y004
				3000 K	●	NL4203110Y002
			98 lm	2700 K	○	NL4203110K006
				3000 K	●	NL4203110K004
				3000 K	●	NL4203110K002
		F 24°	70 lm	2700 K	○	NL4203125Y006
				3000 K	●	NL4203125Y004
				3000 K	●	NL4203125Y002
			98 lm	2700 K	○	NL4203125K006
				3000 K	●	NL4203125K004
				3000 K	●	NL4203125K002

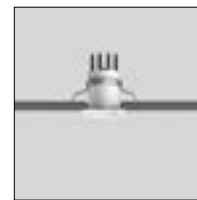

29 x 29 mm

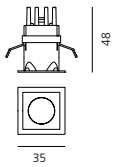

Driver	Vac	L <sub>mm</sub>	W <sub>mm</sub>	H <sub>mm</sub>	Code
cc 8W 500mA slim	220-240	22	110	19	NL19041
*cc 23W 500mA	220-240	156	52	26	M077401*

\*For use only on accessible ceiling

↪ EVERYTHING 55

White Black Silver F WF Driver 500 mA SELV supplied separately. MacAdam 3SDCM Life L80 (13K) 78600h CRI=80 IP20

Round						Code		
W	Weight	Beam	Flux	CCT	Color			
6,4 W	0,20 kg	F 20°	476 lm	2700 K	○	NL4203518Y006		
				3000 K	●	NL4203518Y004		
				3000 K	●	NL4203518Y002		
				476 lm	3000 K	○	NL4203518K006	
					3000 K	●	NL4203518K004	
					3000 K	●	NL4203518K002	
			WF 34°	442 lm	2700 K	○	NL4203534Y006	
					3000 K	●	NL4203534Y004	
					3000 K	●	NL4203534Y002	
				442 lm	3000 K	○	NL4203534K006	
					3000 K	●	NL4203534K004	
					3000 K	●	NL4203534K002	
		8,5 W	0,30 kg	F 20°	634 lm	2700 K	○	NL4204118Y006
						3000 K	●	NL4204118Y004
						3000 K	●	NL4204118Y002
					634 lm	3000 K	○	NL4204118K006
						3000 K	●	NL4204118K004
						3000 K	●	NL4204118K002
				WF 34°	589 lm	2700 K	○	NL4204134Y006
						3000 K	●	NL4204134Y004
						3000 K	●	NL4204134Y002
					589 lm	3000 K	○	NL4204134K006
						3000 K	●	NL4204134K004
						3000 K	●	NL4204134K002

Adjustable		Code
6,4 W	30°	NL4203318Y006
		NL4203318Y004
		NL4203318Y002
		NL4203318K006
		NL4203318K004
		NL4203318K002
		NL4203334Y006
		NL4203334Y004
		NL4203334Y002
		NL4203334K006
		NL4203334K004
		NL4203334K002

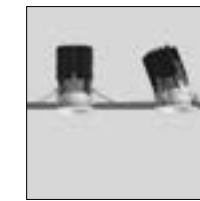

∅ 50 mm

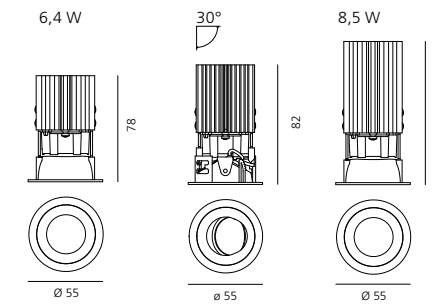

Square						Code		
W	Weight	Beam	Flux	CCT	Color			
6,4 W	0,20 kg	F 20°	476 lm	2700 K	○	NL4203418Y006		
				3000 K	●	NL4203418Y004		
				3000 K	●	NL4203418Y002		
				476 lm	3000 K	○	NL4203418K006	
					3000 K	●	NL4203418K004	
					3000 K	●	NL4203418K002	
			WF 34°	442 lm	2700 K	○	NL4203434Y006	
					3000 K	●	NL4203434Y004	
					3000 K	●	NL4203434Y002	
				442 lm	3000 K	○	NL4203434K006	
					3000 K	●	NL4203434K004	
					3000 K	●	NL4203434K002	
		8,5 W	0,30 kg	F 20°	634 lm	2700 K	○	NL4204218Y006
						3000 K	●	NL4204218Y004
						3000 K	●	NL4204218Y002
					634 lm	3000 K	○	NL4204218K006
						3000 K	●	NL4204218K004
						3000 K	●	NL4204218K002
				WF 34°	589 lm	2700 K	○	NL4204234Y006
						3000 K	●	NL4204234Y004
						3000 K	●	NL4204234Y002
					589 lm	3000 K	○	NL4204234K006
						3000 K	●	NL4204234K004
						3000 K	●	NL4204234K002

Adjustable		Code
6,4 W	30°	NL4203218Y006
		NL4203218Y004
		NL4203218Y002
		NL4203218K006
		NL4203218K004
		NL4203218K002
		NL4203234Y006
		NL4203234Y004
		NL4203234Y002
		NL4203234K006
		NL4203234K004
		NL4203234K002

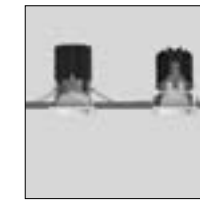

50 x 50 mm

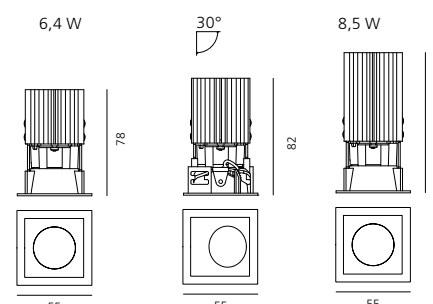

Driver	Vac	L <sub>mm</sub>	W <sub>mm</sub>	H <sub>mm</sub>	Code
cc 15W 500mA	220-240	150	22	19	Everything 55 - 6,4W
cc 25W 500mA	220-240	164	38	25	Everything 55 - 6,4W
*cc 23W 500mA	220-240	156	52	26	Everything 55 - 6,4W
cc 20W 700mA	220-240	125	38	23	Everything 55 - 8,5W
*cc 32W 700mA	220-240	103	67	21	Everything 55 - 8,5W
*cc 32W 700mA	220-240	103	67	21	Everything 55 - 8,5W
cc 25W 700mA	220-240	164	38	25	Everything 55 - 8,5W
*cc 28W 700mA	220-240	156	53	26	Everything 55 - 8,5W

\*For use only on accessible ceiling

⇨ EVERYTHING 80 ROUND

Black White Silver Black White Polished metal F WF Driver 350mA SELV supplied separately. MacAdam 3SDCM Life L80 (9K) 50000h CRI=90 ▼ IP20 / ▲ IP44  
Trim Deflector 850° 30°

Trim						Fixed		Adjustable	
W	Weight	Beam	Flux	CCT	Trim	Deflector	Code	Code	Code
13 W	0,24 kg	F 23°	993 lm	2700 K	<input type="checkbox"/>	<input type="checkbox"/>	M325720	M325725	
					<input type="checkbox"/>	<input type="checkbox"/>	M331110	M331115	
					<input type="checkbox"/>	<input type="checkbox"/>	M331120	M331125	
					<input type="checkbox"/>	<input type="checkbox"/>	M326020	M326025	
					<input type="checkbox"/>	<input type="checkbox"/>	M326010	M326015	
					<input type="checkbox"/>	<input type="checkbox"/>	M326060	M326065	
					<input type="checkbox"/>	<input type="checkbox"/>	M251020	M251025	
					<input type="checkbox"/>	<input type="checkbox"/>	M278610	M278615	
					<input type="checkbox"/>	<input type="checkbox"/>	M278620	M278625	
					<input type="checkbox"/>	<input type="checkbox"/>	M251620	M251625	
					<input type="checkbox"/>	<input type="checkbox"/>	M251610	M251615	
					<input type="checkbox"/>	<input type="checkbox"/>	M251660	M251665	
		F 28°	1007 lm	2700 K	<input type="checkbox"/>	<input type="checkbox"/>	M325820	M325825	
					<input type="checkbox"/>	<input type="checkbox"/>	M331210	M331215	
					<input type="checkbox"/>	<input type="checkbox"/>	M331220	M331225	
					<input type="checkbox"/>	<input type="checkbox"/>	M326120	M326125	
					<input type="checkbox"/>	<input type="checkbox"/>	M326110	M326115	
					<input type="checkbox"/>	<input type="checkbox"/>	M326160	M326165	
					<input type="checkbox"/>	<input type="checkbox"/>	M251220	M251225	
					<input type="checkbox"/>	<input type="checkbox"/>	M278810	M278815	
					<input type="checkbox"/>	<input type="checkbox"/>	M278820	M278825	
					<input type="checkbox"/>	<input type="checkbox"/>	M251820	M251825	
					<input type="checkbox"/>	<input type="checkbox"/>	M251810	M251815	
					<input type="checkbox"/>	<input type="checkbox"/>	M251860	M251865	
WF 46°	986 lm	2700 K	<input type="checkbox"/>	<input type="checkbox"/>	M325920	M325925			
			<input type="checkbox"/>	<input type="checkbox"/>	M331310	M331315			
			<input type="checkbox"/>	<input type="checkbox"/>	M331320	M331325			
			<input type="checkbox"/>	<input type="checkbox"/>	M326220	M326225			
			<input type="checkbox"/>	<input type="checkbox"/>	M326210	M326215			
			<input type="checkbox"/>	<input type="checkbox"/>	M326260	M326265			
			<input type="checkbox"/>	<input type="checkbox"/>	M251420	M251425			
			<input type="checkbox"/>	<input type="checkbox"/>	M279010	M279015			
			<input type="checkbox"/>	<input type="checkbox"/>	M279020	M279025			
			<input type="checkbox"/>	<input type="checkbox"/>	M252020	M252025			
			<input type="checkbox"/>	<input type="checkbox"/>	M252010	M252015			
			<input type="checkbox"/>	<input type="checkbox"/>	M252060	M252065			

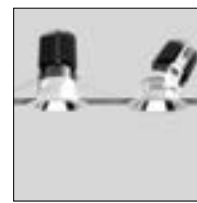

ø 67 mm

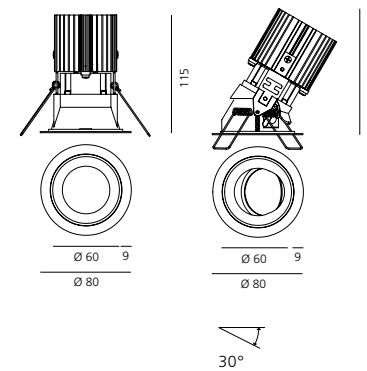

Trimless						Fixed		Adjustable	
W	Weight	Beam	Flux	CCT	Deflector	Code	Code	Code	Code
13 W	0,24 kg	F 23°	993 lm	2700 K	<input type="checkbox"/>	M326300	M326305		
					<input type="checkbox"/>	M326600	M326605		
					<input type="checkbox"/>	M331400	M331405		
					<input type="checkbox"/>	M252200	M252205		
					<input type="checkbox"/>	M252800	M252805		
					<input type="checkbox"/>	M279200	M279205		
					<input type="checkbox"/>	M326400	M326405		
					<input type="checkbox"/>	M326700	M326705		
					<input type="checkbox"/>	M331500	M331505		
					<input type="checkbox"/>	M252400	M252405		
					<input type="checkbox"/>	M253000	M253005		
					<input type="checkbox"/>	M279400	M279405		
		F 28°	1007 lm	2700 K	<input type="checkbox"/>	M326500	M326505		
					<input type="checkbox"/>	M326800	M326805		
					<input type="checkbox"/>	M331600	M331605		
					<input type="checkbox"/>	M252600	M252605		
					<input type="checkbox"/>	M253200	M253205		
					<input type="checkbox"/>	M279600	M279605		

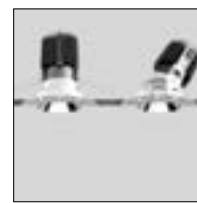

ø 67 mm

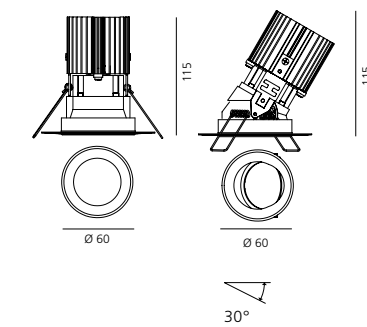

Driver	Vac	L <sub>mm</sub>	W <sub>mm</sub>	H <sub>mm</sub>	Code
cc 15W 350mA	220-240	125	38	23	1max Undimmable M077500
cc 16W 350mA	220-240	156	52	26	1max DALI/PUSH/0-10V dimmable M077401

⇨ EVERYTHING 80 SQUARE

Black White Silver Black White Polished metal F WF Driver 350mA SELV supplied separately. MacAdam 3SDCM Life L80 (9K) 50000h CRI=90 ▼ IP20 / ▲ IP44  
Trim Deflector 850° 30°

Trim						Fixed		Adjustable	
W	Weight	Beam	Flux	CCT	Trim	Deflector	Code	Code	Code
13 W	0,24 kg	F 23°	992 lm	2700 K	<input type="checkbox"/>	<input type="checkbox"/>	M326920	M326925	
					<input type="checkbox"/>	<input type="checkbox"/>	M330510	M330515	
					<input type="checkbox"/>	<input type="checkbox"/>	M330520	M330525	
					<input type="checkbox"/>	<input type="checkbox"/>	M327220	M327225	
					<input type="checkbox"/>	<input type="checkbox"/>	M327210	M327215	
					<input type="checkbox"/>	<input type="checkbox"/>	M327260	M327265	
					<input type="checkbox"/>	<input type="checkbox"/>	M253420	M253425	
					<input type="checkbox"/>	<input type="checkbox"/>	M273610	M273615	
					<input type="checkbox"/>	<input type="checkbox"/>	M273620	M273625	
					<input type="checkbox"/>	<input type="checkbox"/>	M254020	M254025	
					<input type="checkbox"/>	<input type="checkbox"/>	M254010	M254015	
					<input type="checkbox"/>	<input type="checkbox"/>	M254060	M254065	
		F 28°	1003 lm	2700 K	<input type="checkbox"/>	<input type="checkbox"/>	M327020	M327025	
					<input type="checkbox"/>	<input type="checkbox"/>	M330610	M330615	
					<input type="checkbox"/>	<input type="checkbox"/>	M330620	M330625	
					<input type="checkbox"/>	<input type="checkbox"/>	M327320	M327325	
					<input type="checkbox"/>	<input type="checkbox"/>	M327310	M327315	
					<input type="checkbox"/>	<input type="checkbox"/>	M327360	M327365	
					<input type="checkbox"/>	<input type="checkbox"/>	M253620	M253625	
					<input type="checkbox"/>	<input type="checkbox"/>	M273810	M273815	
					<input type="checkbox"/>	<input type="checkbox"/>	M273820	M273825	
					<input type="checkbox"/>	<input type="checkbox"/>	M254220	M254225	
					<input type="checkbox"/>	<input type="checkbox"/>	M254210	M254215	
					<input type="checkbox"/>	<input type="checkbox"/>	M254260	M254265	
WF 46°	986 lm	2700 K	<input type="checkbox"/>	<input type="checkbox"/>	M327120	M327125			
			<input type="checkbox"/>	<input type="checkbox"/>	M330710	M330715			
			<input type="checkbox"/>	<input type="checkbox"/>	M330720	M330725			
			<input type="checkbox"/>	<input type="checkbox"/>	M327420	M327425			
			<input type="checkbox"/>	<input type="checkbox"/>	M327410	M327415			
			<input type="checkbox"/>	<input type="checkbox"/>	M327460	M327465			
			<input type="checkbox"/>	<input type="checkbox"/>	M253820	M253825			
			<input type="checkbox"/>	<input type="checkbox"/>	M274010	M274015			
			<input type="checkbox"/>	<input type="checkbox"/>	M274020	M274025			
			<input type="checkbox"/>	<input type="checkbox"/>	M254420	M254425			
			<input type="checkbox"/>	<input type="checkbox"/>	M254410	M254415			
			<input type="checkbox"/>	<input type="checkbox"/>	M254460	M254465			

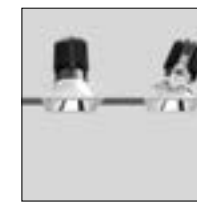

67 x 67 mm

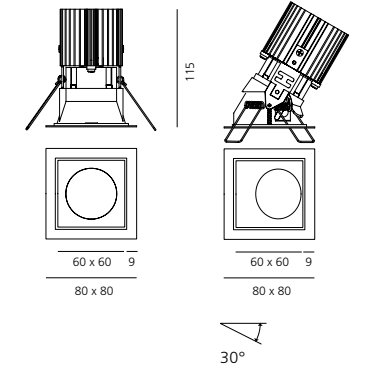

Trimless						Fixed		Adjustable	
W	Weight	Beam	Flux	CCT	Deflector	Code	Code	Code	Code
13 W	0,24 kg	F 23°	992 lm	2700 K	<input type="checkbox"/>	M327500	M327505		
					<input type="checkbox"/>	M327800	M327805		
					<input type="checkbox"/>	M330800	M330805		
					<input type="checkbox"/>	M254600	M254605		
					<input type="checkbox"/>	M255200	M255205		
					<input type="checkbox"/>	M274200	M274205		
					<input type="checkbox"/>	M327600	M327605		
					<input type="checkbox"/>	M327900	M327905		
					<input type="checkbox"/>	M330900	M330905		
					<input type="checkbox"/>	M254800	M254805		
					<input type="checkbox"/>	M255400	M255405		
					<input type="checkbox"/>	M274400	M274405		
		F 28°	1003 lm	2700 K	<input type="checkbox"/>	M327700	M327705		
					<input type="checkbox"/>	M328000	M328005		
					<input type="checkbox"/>	M331000	M331005		
					<input type="checkbox"/>	M255000	M255005		
					<input type="checkbox"/>	M255600	M255605		
					<input type="checkbox"/>	M274600	M274605		



67 x 67 mm

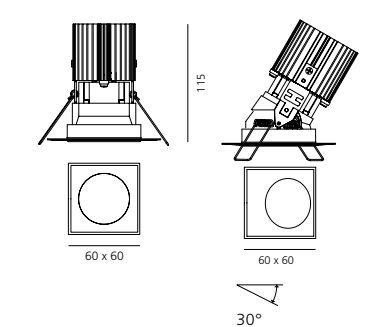

Driver	Vac	L <sub>mm</sub>	W <sub>mm</sub>	H <sub>mm</sub>	Code
cc 15W 350mA	220-240	125	38	23	1max Undimmable M077500
cc 16W 350mA	220-240	156	52	26	1max DALI/PUSH/0-10V dimmable M077401

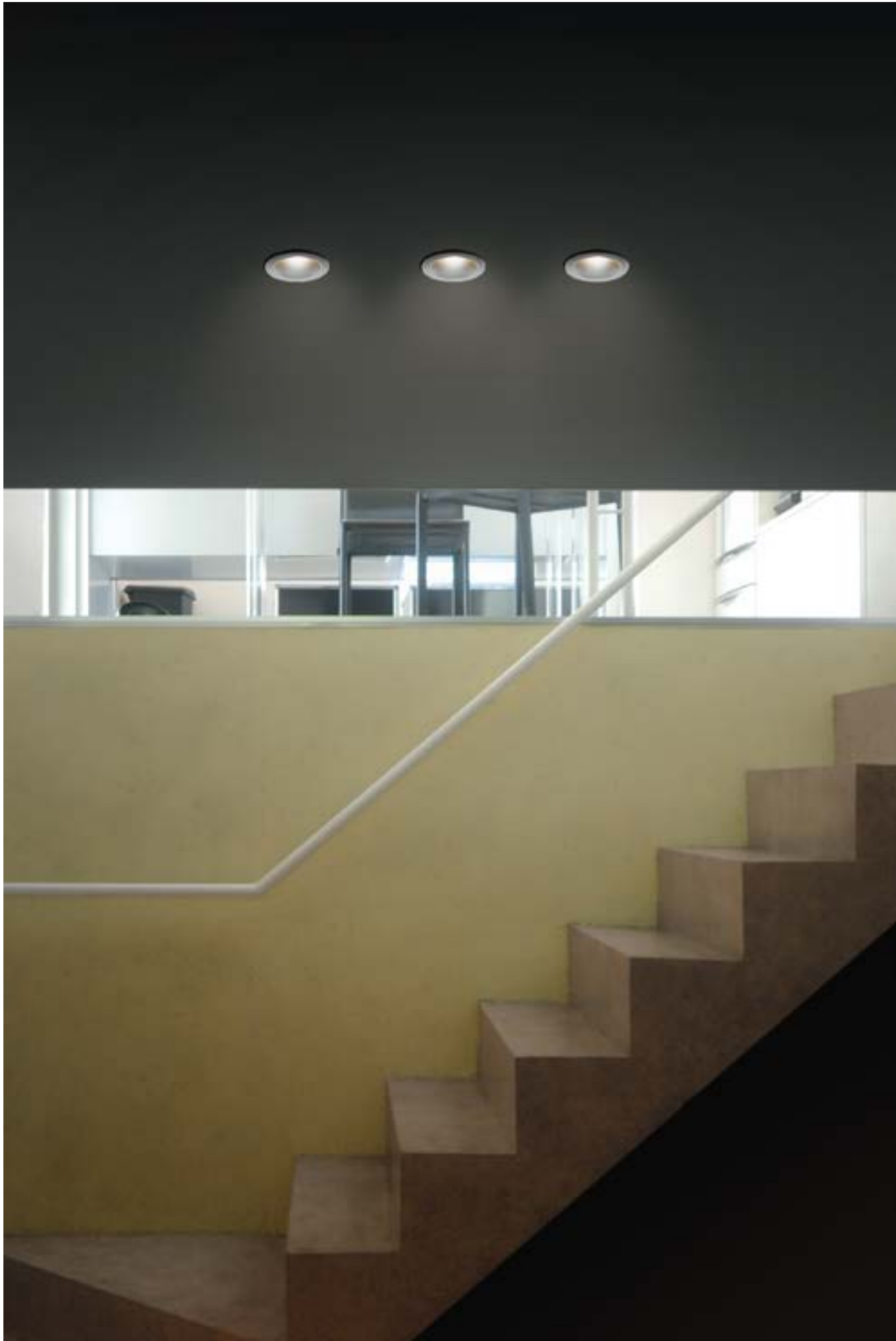



↳ EVERYTHING 105 TRIM

Black White Silver Black Polished metal  
Trim Deflector

F WF

Driver 350mA SELV supplied separately.

MacAdam 3SDCM Life L80 (9K) 50000h CRI=90

▼ IP20 / ▲ IP44  
 850°  
 30° 360°

Round						Fixed	Adjustable
W	Weight	Beam	Flux	CCT	Trim	Code	Code
13 W	0,30 kg	F 25°	821 lm	2700 K	○	M328120	M328125
					●	M328160	M328165
					○	M328140	M328145
					●	M328420	M328425
					○	M328460	M328465
					●	M328440	M328445
			858 lm	3000 K	○	M255820	M255825
					●	M255860	M255865
					○	M255840	M255845
					●	M256420	M256425
					○	M256460	M256465
					●	M256440	M256445
		F 28°	818 lm	2700 K	○	M328220	M328225
					●	M328260	M328265
					○	M328240	M328245
					●	M328520	M328525
					○	M328560	M328565
					●	M328540	M328545
			855 lm	3000 K	○	M256020	M256025
					●	M256060	M256065
					○	M256040	M256045
					●	M256620	M256625
					○	M256660	M256665
					●	M256640	M256645
		WF 46°	696 lm	2700 K	○	M328320	M328325
					●	M328360	M328365
					○	M328340	M328345
					●	M256220	M256225
			727 lm	3000 K	○	M256260	M256265
					●	M256240	M256245

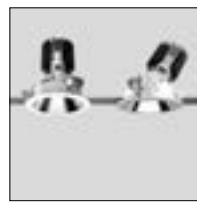

ø 92 mm

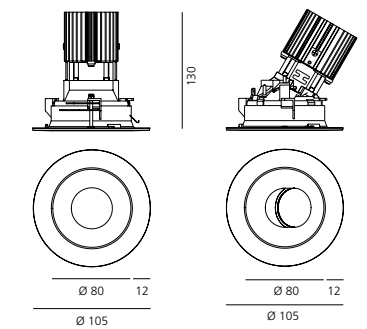

Square						Fixed	Adjustable
W	Weight	Beam	Flux	CCT	Trim	Code	Code
13 W	0,30 kg	F 25°	850 lm	2700 K	○	M329320	M329325
					●	M329360	M329365
					○	M329340	M329345
					●	M329620	M329625
					○	M329660	M329665
					●	M329640	M329645
			888 lm	3000 K	○	M258220	M258225
					●	M258260	M258265
					○	M258240	M258245
					●	M258820	M258825
					○	M258860	M258865
					●	M258840	M258845
		F 28°	866 lm	2700 K	○	M329420	M329425
					●	M329460	M329465
					○	M329440	M329445
					●	M329720	M329725
					○	M329760	M329765
					●	M329740	M329745
			905 lm	3000 K	○	M258420	M258425
					●	M258460	M258465
					○	M258440	M258445
					●	M259020	M259025
					○	M259060	M259065
					●	M259040	M259045
		WF 46°	708 lm	2700 K	○	M329520	M329525
					●	M329560	M329565
					○	M329540	M329545
					●	M258620	M258625
			739 lm	3000 K	○	M258660	M258665
					●	M258640	M258645

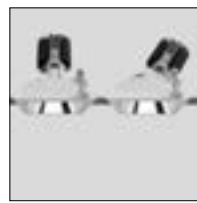

92 x 92 mm

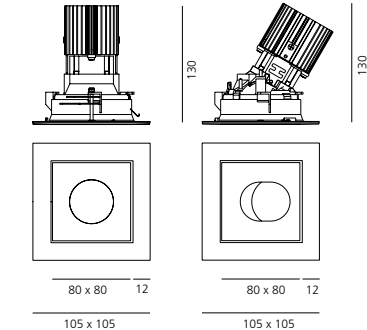

Driver	Vac	L <sub>mm</sub>	W <sub>mm</sub>	H <sub>mm</sub>	Code
cc 15W 350mA	220-240	125	38	23	1max Undimmable
cc 16W 350mA	220-240	156	52	26	1max DALI/PUSH/0-10V dimmable

↳ EVERYTHING 105 KIT TRIMLESS

Black Polished metal

F WF

Driver 350mA SELV supplied separately.

MacAdam 3SDCM Life L80 (9K) 50000h CRI=90

▼ IP20 / ▲ IP44  
 850°  
 30° 360°

Fitting to be completed with installation frame for recessing into ceiling.

Round optical unit: trimless						Fixed	Adjustable
W	Weight	Beam	Flux	CCT	Deflector	Code	Code
13 W	0,30 kg	F 25°	821 lm	2700 K	●	M328700	M328705
					○	M329000	M329005
					●	M257000	M257005
					○	M257600	M257605
		F 28°	818 lm	2700 K	●	M328800	M328805
					○	M329100	M329105
					●	M257200	M257205
			855 lm	3000 K	○	M257800	M257805
					●	M328900	M328905
		WF 46°	696 lm	2700 K	●	M257400	M257405
					○		
			727 lm	3000 K	●		

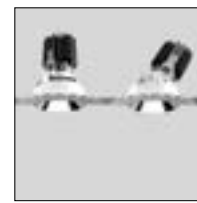

ø 92 mm

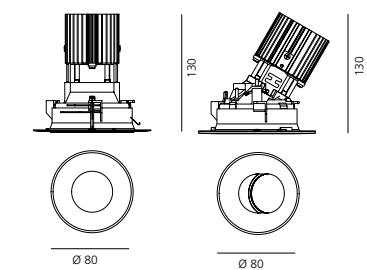

**Frame**

Round frame for recessed installation

Code M273400

ø 92 mm

Square optical unit: trimless						Fixed	Adjustable
W	Weight	Beam	Flux	CCT	Deflector	Code	Code
13 W	0,30 kg	F 25°	850 lm	2700 K	●	M329900	M329905
					○	M330200	M330205
					●	M259400	M259405
					○	M260000	M260005
		F 28°	866 lm	2700 K	●	M330000	M330005
					○	M330300	M330305
					●	M259600	M259605
					○	M260200	M260205
		WF 46°	708 lm	2700 K	●	M330100	M330105
					○	M259800	M259805
			739 lm	3000 K	●		



92 x 92 mm

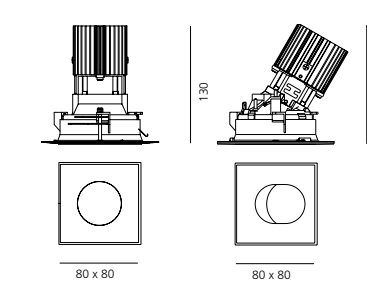

**Frame**

Square frame for recessed installation

Code M273500

92 x 92 mm

Driver	Vac	L <sub>mm</sub>	W <sub>mm</sub>	H <sub>mm</sub>	Code
cc 15W 350mA	220-240	125	38	23	1max Undimmable
cc 16W 350mA	220-240	156	52	26	1max DALI/PUSH/0-10V dimmable

↳ EVERYTHING 150 TRIM

Black White Silver Black Polished metal

Trim Deflector

F WF

Driver 700mA SELV supplied separately.

MacAdam 3SDCM Life L80 (9K) 50000h CRI=90

▼ IP20 / ▲ IP44  
 ⌀ 850°  
 30° 360°

Round						Fixed	Adjustable			
W	Weight	Beam	Flux	CCT	Trim	Deflector	Code	Code		
24 W	0,30 kg	F 18°	1957 lm	2700 K	○	●	M323320	M323325		
					●	●	M323360	M323365		
					○	●	M323340	M323345		
					●	●	M323620	M323625		
					○	●	M323660	M323665		
					●	●	M323640	M323645		
					2045 lm	3000 K	○	●	M260620	M260625
							●	●	M260660	M260665
							○	●	M260640	M260645
							●	●	M261220	M261225
							○	●	M261260	M261265
							●	●	M261240	M261245
F 28°	1727 lm	2700 K	○	●	M323420	M323425				
			●	●	M323460	M323465				
			○	●	M323440	M323445				
			○	●	M323820	M323825				
			○	●	M323860	M323865				
			●	●	M323840	M323845				
1804 lm	3000 K	○	●	M260820	M260825					
		●	●	M260860	M260865					
		○	●	M260840	M260845					
		○	●	M261620	M261625					
		○	●	M261660	M261665					
		●	●	M261640	M261645					
WF 46°	1606 lm	2700 K	○	●	M323520	M323525				
			○	●	M323560	M323565				
			○	●	M323540	M323545				
			○	●	M261020	M261025				
			○	●	M261060	M261065				
			●	●	M261040	M261045				

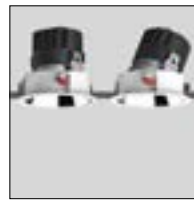

⌀ 136 mm

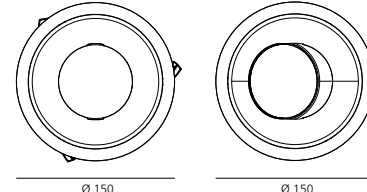
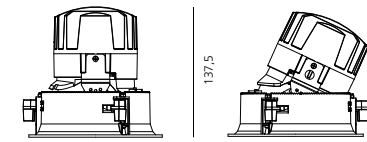

Square						Fixed	Adjustable			
W	Weight	Beam	Flux	CCT	Trim	Deflector	Code	Code		
24 W	0,30 kg	F 18°	1957 lm	2700 K	○	●	M324520	M324525		
					●	●	M324560	M324565		
					○	●	M324540	M324545		
					○	●	M324820	M324825		
					○	●	M324860	M324865		
					●	●	M324840	M324845		
					2045 lm	3000 K	○	●	M263020	M263025
							○	●	M263060	M263065
							○	●	M263040	M263045
							○	●	M263620	M263625
							○	●	M263660	M263665
							●	●	M263640	M263645
F 28°	1727 lm	2700 K	○	●	M324620	M324625				
			○	●	M324660	M324665				
			○	●	M324640	M324645				
			○	●	M325020	M325025				
			○	●	M325060	M325065				
			●	●	M325040	M325045				
1804 lm	3000 K	○	●	M263220	M263225					
		○	●	M263260	M263265					
		○	●	M263240	M263245					
		○	●	M264020	M264025					
		○	●	M264060	M264065					
		●	●	M264040	M264045					
WF 46°	1606 lm	2700 K	○	●	M324720	M324725				
			○	●	M324760	M324765				
			○	●	M324740	M324745				
			○	●	M263420	M263425				
			○	●	M263460	M263465				
			●	●	M263440	M263445				



136 x 136 mm

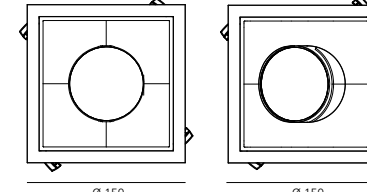
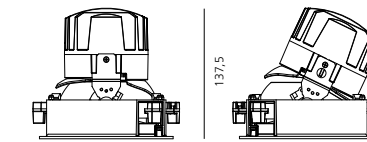

Driver	Vac	L <sub>mm</sub>	W <sub>mm</sub>	H <sub>mm</sub>	Code
cc 30W 700mA	220-240	165	43	30	1max Undimmable <b>M076800</b>
cc 36W 700mA	220-240	103	67	21	1max DALI dimmable <b>M079200</b>
cc 32W 700mA	220-240	103	67	21	1max PUSH/0-10V dimmable <b>M079300</b>

↳ EVERYTHING 150 KIT TRIMLESS

Black Polished metal

F WF

Driver 700mA SELV supplied separately.

MacAdam 3SDCM Life L80 (9K) 50000h CRI=90

▼ IP20 / ▲ IP44  
 ⌀ 850°  
 30° 360°

Fitting to be completed with installation frame for recessing into ceiling.

Round optical unit: trimless						Fixed	Adjustable					
W	Weight	Beam	Flux	CCT	Deflector	Code	Code					
24 W	0,30 kg	F 18°	1957 lm	2700 K	●	M323900	M323905					
					○	M324200	M324205					
					○	M261800	M261805					
					○	M262400	M262405					
					○	M324000	M324005					
					○	M324300	M324305					
					2045 lm	3000 K	○	M262000	M262005			
							○	M262600	M262605			
							○	M324100	M324105			
							○	M262200	M262205			
							F 28°	1727 lm	2700 K	○	M262000	M262005
										○	M262600	M262605
○	M324100	M324105										
○	M262200	M262205										
1804 lm	3000 K	○	M262000	M262005								
		○	M262600	M262605								
		○	M324100	M324105								
		○	M262200	M262205								
		WF 46°	1606 lm	2700 K	○	M262000	M262005					
					○	M262600	M262605					
○	M324100				M324105							
○	M262200				M262205							
1677 lm	3000 K				○	M262000	M262005					
					○	M262600	M262605					
		○	M324100	M324105								
		○	M262200	M262205								

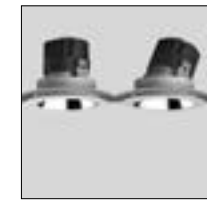

⌀ 136 mm

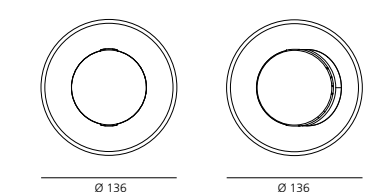
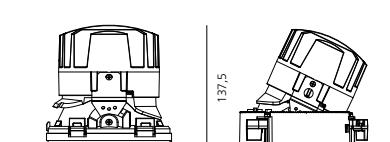

**Frame**

Round frame for recessed installation

⌀ 136 mm

Code **M274800**

Square optical unit: trimless						Fixed	Adjustable					
W	Weight	Beam	Flux	CCT	Deflector	Code	Code					
24 W	0,30 kg	F 18°	1957 lm	2700 K	●	M325100	M325105					
					○	M325400	M325405					
					○	M264200	M264205					
					○	M264800	M264805					
					○	M325200	M325205					
					○	M325500	M325505					
					2045 lm	3000 K	○	M264400	M264405			
							○	M265000	M265005			
							○	M325300	M325305			
							○	M264600	M264605			
							F 28°	1727 lm	2700 K	○	M264400	M264405
										○	M265000	M265005
○	M325300	M325305										
○	M264600	M264605										
1804 lm	3000 K	○	M264400	M264405								
		○	M265000	M265005								
		○	M325300	M325305								
		○	M264600	M264605								
		WF 46°	1606 lm	2700 K	○	M264400	M264405					
					○	M265000	M265005					
○	M325300				M325305							
○	M264600				M264605							

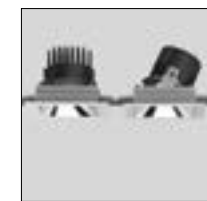

136 x 136 mm

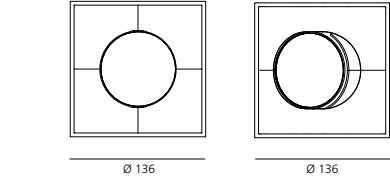
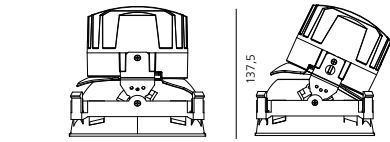

**Frame**

Square frame for recessed installation

136 x 136 mm

Code **M274900**

Driver	Vac	L <sub>mm</sub>	W <sub>mm</sub>	H <sub>mm</sub>	Code
cc 30W 700mA	220-240	165	43	30	1max Undimmable <b>M076800</b>
cc 36W 700mA	220-240	103	67	21	1max DALI dimmable <b>M079200</b>
cc 32W 700mA	220-240	103	67	21	1max PUSH/0-10V dimmable <b>M079300</b>



# Una Pro 75

Carlotta de Bevilacqua

↪ 2010



High-power LED lighting appliance mounted on a thin (3 mm) flat aluminium sheet with improved heat dissipation.

Each head accommodates 4-LED circuits.

Available with three different emissions: 6°, 20°, 38°.

The different versions feature 1 or 2 heads.

The junction allows 360° rotation and 30° tilting in all directions.

The addition of a clear cap with magnetic joint allows to reach protection rating IP44.



For further information on Una Pro 75  
↪ visit [artemide.com](http://artemide.com)



**Artemide  
App**

↪ on request

Only for recessed version



# Una Pro 75 beam angles

↪ 6° - EXTRA SPOT

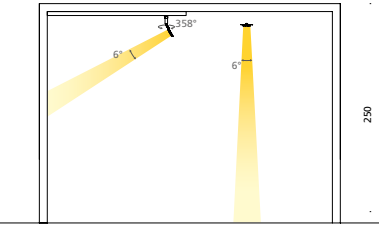
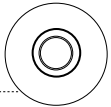
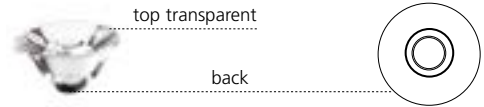

XS = extra spot (<math><8^\circ</math>)

↪ 20° - FLOOD

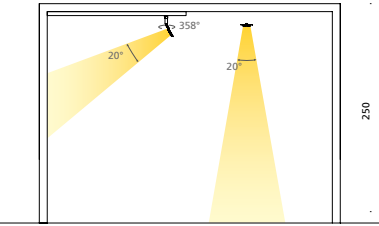
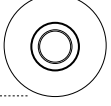
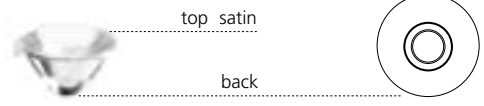

F = flood (15°-30°)

↪ 38° - WIDE FLOOD

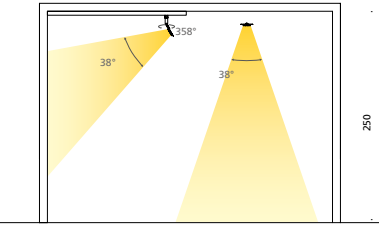
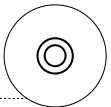
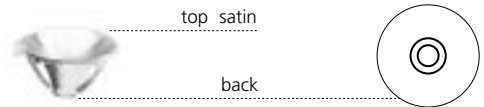

WF = wide flood (30°-45°)

# Una Pro 75 colors



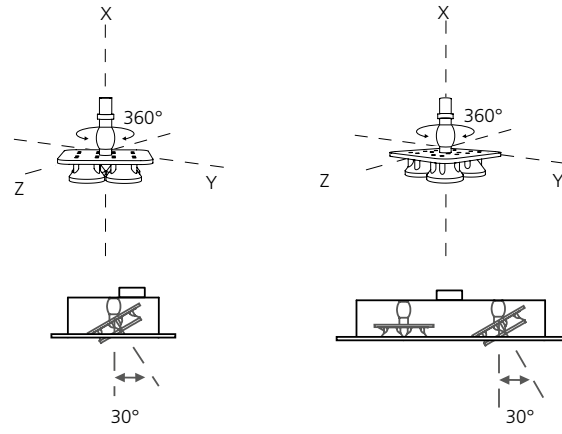

# Una Pro 75 joint

The junction allows 360° rotation and 30° tilting in all directions. This movement is suited either to reach any individual points on horizontal or vertical surfaces requiring accent light or to evenly distribute the emitted light through space.

Each 4-LED head in the multiple compositions can be adjusted individually, so that each light beam can be directed independently of the others to stress different points in space by installing one appliance.

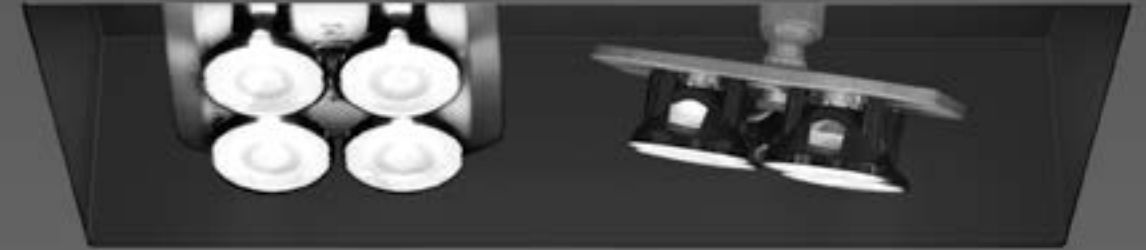

## UNA PRO 75 RECESSED

White Aluminium Black
XS F WF
Electronic ballast included not dimmable
MacAdam 4SDCM Life L70 (7K) 42300h CRI =80/85
IP20

Undimmable									
W	Weight	Beam	CRI	Flux	CCT	Box	Head	Holder	Code
4 LED 6 W	0,40 kg	6°	=85	320 lm	3000K	●	○	●	DD0014I00D1W
			=80	340 lm	3700K	○	○	○	DD0014I10D1BW
		20°	=85	313 lm	3000K	●	○	●	DD0014I00D1
			=80	333 lm	3700K	○	○	○	DD0014I10D1B
		38°	=85	297 lm	3000K	●	○	●	DD0014I00D2W
			=80	316 lm	3700K	○	○	○	DD0014I10D2BW
2x4 LED 14 W	0,90 kg	6°	=85	640 lm	3000K	●	○	●	DD0014L00D1W
			=80	680 lm	3700K	○	○	○	DD0014L10D1BW
		20°	=85	626 lm	3000K	●	○	●	DD0014L00D1
			=80	666 lm	3700K	○	○	○	DD0014L10D1B
		38°	=85	594 lm	3000K	●	○	●	DD0014L00D2W
			=80	632 lm	3700K	○	○	○	DD0014L10D2BW

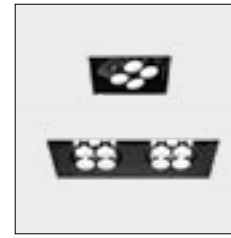

4 LED: 110x110 mm  
2x 4 LED: 110x210 mm

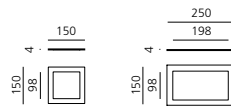
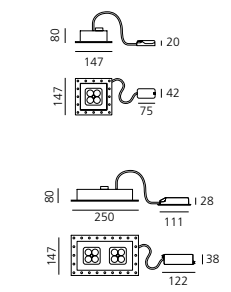

### Accessories

	Color	Code
	○	DD0014IFR10
	●	DD0014IFR09
	○	DD0014LFR10
	●	DD0014LFR09
		DD0014ICLT44



## UNA PRO 75 SMD

White Aluminium Black
XS F WF
Electronic ballast included not dimmable
MacAdam 4SDCM Life L70 (7K) 42300h CRI =80/85
IP20

Undimmable									
W	Weight	Beam	CRI	Flux	CCT	Box	Head	Holder	Code
4 LED 6 W	0,50 kg	6°	=85	320 lm	3000K	●	○	●	DD0014I09D1SW
			=80	340 lm	3700K	○	○	○	DD0014I10D1SW
		20°	=85	313 lm	3000K	●	○	●	DD0014I00D1SW
			=80	333 lm	3700K	○	○	○	DD0014I09D1S
		38°	=85	297 lm	3000K	●	○	●	DD0014I10D1S
			=80	316 lm	3700K	○	○	○	DD0014I00D1S
2x4 LED 14 W	0,90 kg	6°	=85	640 lm	3000K	●	○	●	DD0014I09D2SW
			=80	680 lm	3700K	○	○	○	DD0014I10D2SW
		20°	=85	626 lm	3000K	●	○	●	DD0014I00D2S
			=80	666 lm	3700K	○	○	○	DD0014I09D2S
		38°	=85	594 lm	3000K	●	○	●	DD0014I10D2S
			=80	632 lm	3700K	○	○	○	DD0014I00D3SW

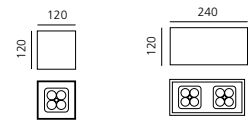
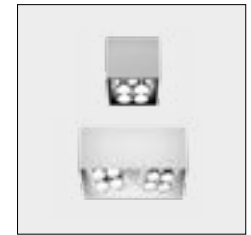

### Accessories

	Code
	DD0014ICLT44





# Una Pro 150

Carlotta de Bevilacqua

↪ 2010

High-power LED lighting appliance mounted on a thin (3 mm) flat aluminium sheet with improved heat dissipation

The head accommodates a 9-LED circuit

Available with three different emissions: 6°, 20°, 38°

Available in two different heights (15 cm or 30 cm)



For further information on Una Pro 150  
↪ visit [artemide.com](http://artemide.com)





# Una Pro 150 beam angles

↪ 6° - EXTRA SPOT

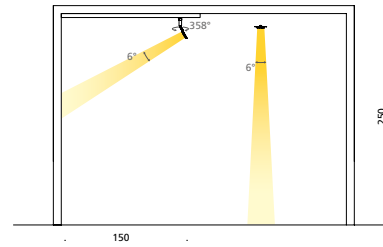
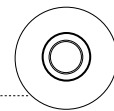

XS = extra spot (<math><8^\circ</math>)

↪ 20° - FLOOD

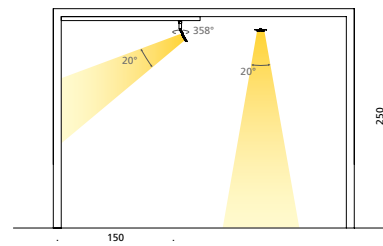
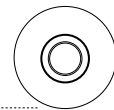

F = flood (15°-30°)

↪ 38° - WIDE FLOOD

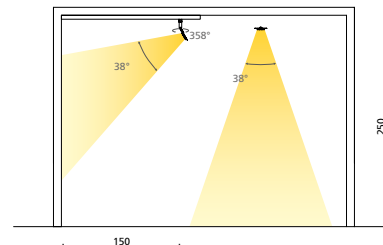
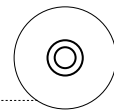

WF = wide flood (30°-45°)

# Una Pro 150 colors

White



Black



White



Aluminium



Black



Black



Black





↪ UNA PRO 150

White	Aluminium	Black	XS	F	WF	Electronic ballast included not dimmable	MacAdam 4SDCM Life L70 (7K) 42300h CRI = 80/85	IP20

**H 15**

W	Weight	Beam	CRI	Flux	CCT	Box	Head	Holder	Code
9 LED 10,5 W	1,10 kg	6°	85	536 lm	3000K	●	●	●	DD0016A09A1CW
						○	○	○	DD0016A10A1CW
			80	570 lm	3700K	○	○	●	DD0016A00A1CW
						●	●	●	DD0016A09A1C
		20°	85	529 lm	3000K	○	○	○	DD0016A10A1C
						○	○	●	DD0016A00A1C
		80	563 lm	3700K	●	●	●	DD0016A09A2CW	
					○	○	○	DD0016A10A2CW	
		38°	85	517 lm	3000K	○	○	●	DD0016A00A2CW
						●	●	●	DD0016A09A2C
		80	550 lm	3700K	○	○	○	DD0016A10A2C	
					○	○	○	DD0016A00A2C	
80	550 lm	3700K	●	●	●	DD0016A09A3CW			
			○	○	○	DD0016A10A3CW			
80	550 lm	3700K	○	○	○	DD0016A00A3CW			
			○	○	○	DD0016A09A3C			
80	550 lm	3700K	○	○	○	DD0016A10A3C			
			○	○	●	DD0016A00A3C			

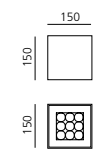

**H 30**

W	Weight	Beam	CRI	Flux	CCT	Box	Head	Holder	Code
9 LED 10,5 W	1,80 kg	6°	85	536 lm	3000K	●	●	●	DD0016A09A1LW
						○	○	○	DD0016A10A1LW
			80	570 lm	3700K	○	○	●	DD0016A00A1LW
						●	●	●	DD0016A09A1L
		20°	85	529 lm	3000K	○	○	○	DD0016A10A1L
						○	○	●	DD0016A00A1L
		80	563 lm	3700K	●	●	●	DD0016A09A2LW	
					○	○	○	DD0016A10A2LW	
		38°	85	517 lm	3000K	○	○	●	DD0016A00A2LW
						●	●	●	DD0016A09A2L
		80	550 lm	3700K	○	○	○	DD0016A10A2L	
					○	○	○	DD0016A00A2L	
80	550 lm	3700K	●	●	●	DD0016A09A3LW			
			○	○	○	DD0016A10A3LW			
80	550 lm	3700K	○	○	○	DD0016A00A3LW			
			○	○	○	DD0016A09A3L			
80	550 lm	3700K	○	○	○	DD0016A10A3L			
			○	○	●	DD0016A00A3L			

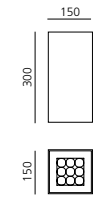
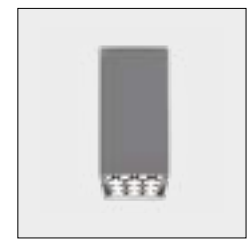



# Pad 80

Carlotta de Bevilacqua

↪ 2012



# Pad 80 typologies



Efficient, clear accent lighting,  
fixed and adjustable.

Excellent lighting efficiency > 70lm/W.

High adjustability: 360° rotation,  
+90°/-90° tilt angle.

Fixed version available as IP44.

Easy installation of light modules,  
no tools required.

Lighting units available in 3 finishes:  
gloss aluminium, painted white, painted black.

Structural elements of recessed-mounted version  
available in 3 sizes, for use with 1, 2, 3 and 2x2  
modules. 3 compatible finishes (polished  
aluminium, white, and black).

Housing of ceiling-mounted version available  
in 3 sizes (1, 2, 3 lighting units), and 3 compatible  
finishes (polished aluminium, white and black).

Recessed-mounted version available as trimless  
or framed.

Materials: body in anodised extruded aluminium,  
diffuser in opal polycarbonate.

Complies with standard EN60598-1  
and other specific standards.



For further information on Pad 80  
↪ visit [artemide.com](http://artemide.com)



Artemide  
App

↪ on request

Only for recessed version

## ↳ PAD80 STRUCTURE

White Black Gloss anodised



### PAD 80 RECESSED

#### Frame for recessed installation

for 1 optic unit	103x103
for 2 optic units	103x186
for 3 optic units	103x271
for 4 optic units	189x189

#### Trim

Code
<b>M2468.</b> 20/10
<b>M2469.</b> 20/10
<b>M2470.</b> 20/10
<b>M2471.</b> 20/10

#### Trimless

Code
<b>M2464.</b> 20/10
<b>M2465.</b> 20/10
<b>M2466.</b> 20/10
<b>M2467.</b> 20/10



Independent power supply and optic units, to be ordered separately.  
Plasterboard thickness from 1mm to 40mm

#### Trimless

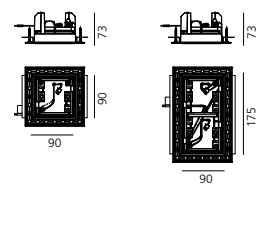

#### Trim

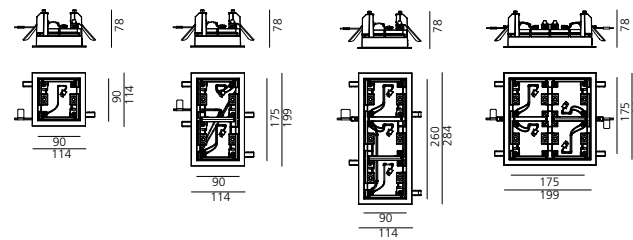

### PAD 80 CEILING

#### Frame for ceiling version

for 1 optic unit	11 W	96x96x109 h
for 2 optics units	21 W	96x181x109 h
for 3 optics units	32 W	96x266x109 h

#### Code

<b>M2472.</b> 20/10
60
<b>M2473.</b> 20/10
60
<b>M2474.</b> 20/10
60



Optic units, to be ordered separately.

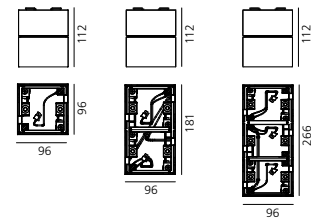

## ↳ PAD80 LIGHT UNIT

White Black Gloss anodised S F WF XF

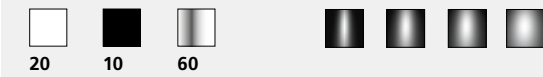

MacAdam4SDCM  
Life L90 (10K) 60500h  
CRI=80

▼ IP20 / ▲ IP44



### PAD 80 LED WITH FIXED LENSES

#### LED optic unit

W	Weight	Beam	Flux	CCT
9,5 W	0,35 kg	S 15°	710 lm	3000 K
			810 lm	4000 K
		F 24°	610 lm	3000 K
			695 lm	4000 K
		WF 36°	645 lm	3000 K
			735 lm	4000 K

#### Code

<b>M2450.</b> 20/10
60
<b>M2454.</b> 20/10
60
<b>M2451.</b> 20/10
60
<b>M2455.</b> 20/10
60
<b>M2452.</b> 20/10
60
<b>M2456.</b> 20/10
60

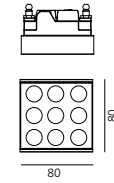

### PAD 80 LED WITH ADJUSTABLE LENSES

#### LED optic unit

W	Weight	Beam	Flux	CCT
9,5 W	0,36 kg	S 15°	710 lm	3000 K
			810 lm	4000 K
		F 24°	610 lm	3000 K
			695 lm	4000 K
		WF 36°	645 lm	3000 K
			735 lm	4000 K

#### Code

<b>M2458.</b> 20/10
60
<b>M2461.</b> 20/10
60
<b>M2459.</b> 20/10
60
<b>M2462.</b> 20/10
60
<b>M2460.</b> 20/10
60
<b>M2463.</b> 20/10
60

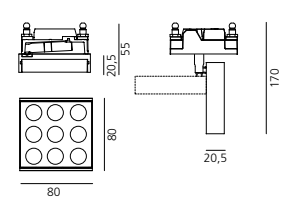

### PAD 80 FIXED DIFFUSER

#### LED optic unit

W (LED)	Weight	Beam	Flux	CCT
9,5 W	0,35 kg	XF 98°	620 lm	3000 K
			704 lm	4000 K

#### Code

<b>M2453.</b> 20/10
60
<b>M2457.</b> 20/10
60

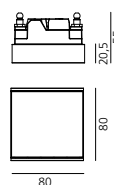

#### Driver Vac optc unit

19W 350mA SELV. 220-240	1	Undimmable
20W 350mA SELV. 220-240	2	Undimmable
2x20W 350mA SELV. 220-240	2x2	Undimmable
35W 350mA SELV.120 220-240	3	Undimmable
20W 350mA SELV. 220-240	1 / 2	DALI
35W 350mA SELV.120 220-240	3	DALI
2x20W 350mA SELV. 220-240	2x2	DALI

#### Code

<b>M074600</b>
<b>DV1058</b>
<b>DV1058 (x2)</b>
<b>M076400</b>
<b>DV1003</b>
<b>M076600</b>
<b>DV1003 (x2)</b>



Private residence, Milan (Italy)



Arts&Foods, Triennale di Milano, Milano (It), 2015, Studio Italo Rota, ph. Federico Villa

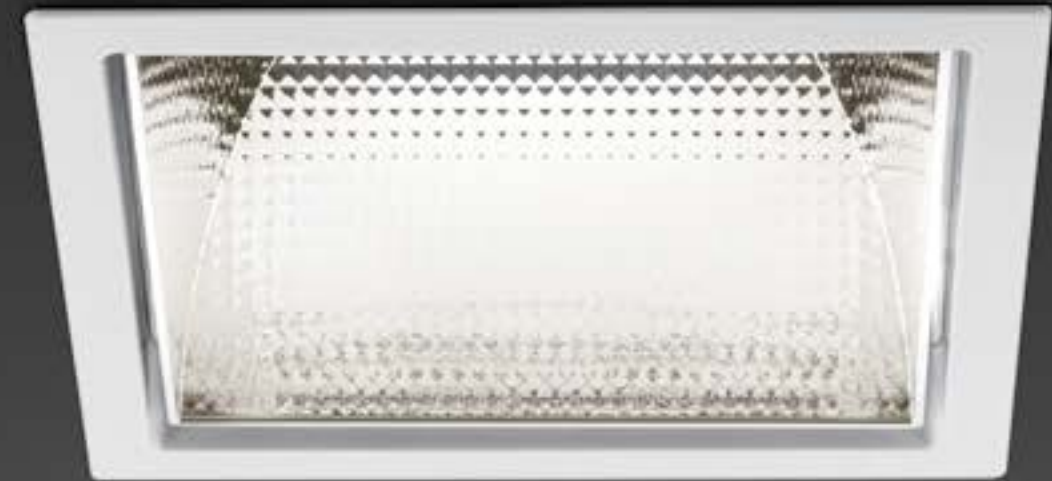

# Luceri

Studio Artemide  
↪ 2011



For further information on Luceri  
↪ visit [artemide.com](http://artemide.com)



LUCERI LED TRIM



LUCERI LED TRIMLESS

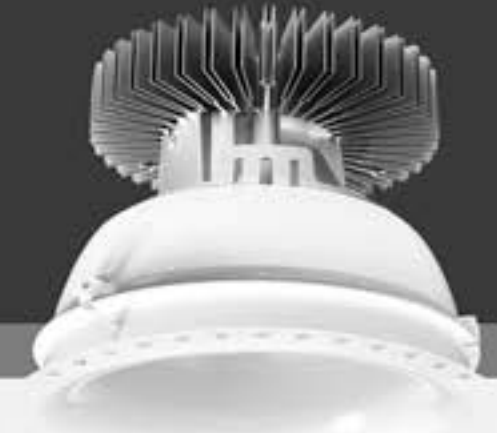

- White frame
- Grey frame
- Black frame



Sharp edge trim



Rounded edge trim

# Luceri

## ↪ Round

Recessed fixed downlighters using high-output LEDs.

Two versions: trim (with bezel) and Trimless (recessed ceiling mounted without bezel)

Materials: bezel, white reflector and screens in polycarbonate, reflectors in vacuum-metalled polycarbonate with anti-scratch surface treatment.

Standard version IP44.  
IP54 with the addition of an optional screen.

Compliant to standard EN60598-1, EN62471 and other specific standards.

### Luceri trim

Complete with optic housing and trim.  
Trim available in white, black or grey.

Professional mirror optic with UGR Luminance Control <19 for office spaces with computer screens.

Installation brackets for an easy, tool-free installation on false ceilings of thicknesses between 1 and 25 mm.

Optional screens in transparent polycarbonate, easy to install, opal and prismoptic diffuser, with a 90 degree turn.

Wide beam symmetrical distribution.

### Luceri trimless

2 available trims:  
Sharp edge  
Rounded edge

2 available optic housings.

Professional mirror optic with UGR Luminance Control <19 for office spaces with computer screens.

Comfort white optics.

Optics housings and trim to be ordered separately.

Optional screens in transparent polycarbonate, easy to install, opal and prismoptic diffuser, with a 90 degree turn.  
Wide beam symmetrical distribution.



## ↳ LUCERI ROUND TRIMLESS

White XF 220/240Vac 50/60Hz supplied separately. MacAdam 1SDCM Life L80 (10K) 55000h CRI= 90

White XF

Fitting to be completed with installation frame.

▼ IP20 / ▲ IP44 screenless.  
▼ IP20 / ▲ IP54 with screen.

### COMFORT WHITE OPTICS

Fixed white						Code
W	Weight	Beam	CCT	Driver Flux		
max 54 W	1,70 kg	69°	3000 K	50 W	4420 lm	<b>BB00300</b>
				35 W	2538 lm	
				50 W	4712 lm	<b>BB00400</b>
				35 W	2714 lm	

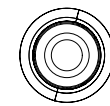
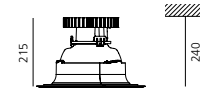
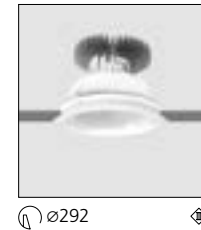

**TW**<sup>®</sup>  
Artemide Tunable White

Tunable white						DALI 8 Code
W	CRI	Weight	Beam	CCT	Flux	
17 W	=80	1,70 kg	70°	2700 K-	1559 lm	<b>BB00500</b>
				6500 K	1804 lm	

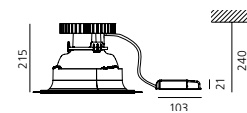
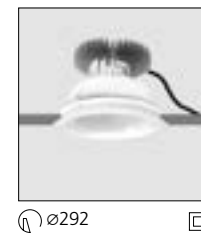

220/240Vac 50/60Hz electronic ballast included

### FACETED MIRROR OPTICS

Fixed white						Code
W	Weight	Beam	CCT	Driver Flux		
max 54 W	1,70 kg	72°	3000 K	50 W	4528 lm	<b>BB01000</b>
				35 W	2600 lm	
				50 W	4828 lm	<b>BB01100</b>
				35 W	2781 lm	

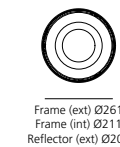
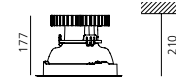
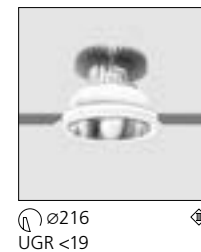

**TW**<sup>®</sup>  
Artemide Tunable White

Tunable white						DALI 8 Code
W	CRI	Weight	Beam	CCT	Flux	
16 W	=80	1,70 kg	71°	2700 K-	1583 lm	<b>BB01200</b>
				6500 K	1830 lm	

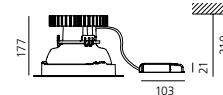

220/240Vac 50/60Hz electronic ballast included

### Installation frame

		Code
	Sharp edge trim	<b>M240500</b>
	Support with rounded edge trim	<b>M240600</b>
	Accessory for ceiling installation	<b>M239820</b>

## ↳ LUCERI ROUND TRIM

White Black Grey XF 220/240Vac 50/60Hz supplied separately. MacAdam 1SDCM Life L80 (10K) 55000h CRI= 90

White Black Grey XF

Fitting to be completed with installation frame.

▼ IP20 / ▲ IP44 screenless.  
▼ IP20 / ▲ IP54 with screen.

### FACETED MIRROR OPTICS

Fixed white						Code
W	Weight	Beam	CCT	Driver Flux		
max 54 W	1,70 kg	72°	3000 K	50 W	4528 lm	<b>BB020.</b> 01/04
				35 W	2600 lm	
				50 W	4828 lm	<b>BB021.</b> 01/04
				35 W	2781 lm	

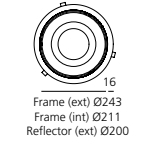
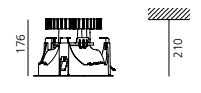
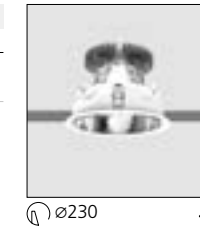

**TW**<sup>®</sup>  
Artemide Tunable White

Tunable white						DALI 8 Code
W	CRI	Weight	Beam	CCT	Flux	
17 W	=80	1,70 kg	71°	2700 K-	1583 lm	<b>BB022.</b> 01/04
				6500 K	1830 lm	

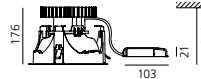
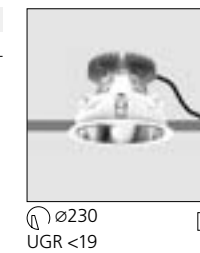

220/240Vac 50/60Hz electronic ballast included

### Accessories

		Code
	Transparent screen in polycarbonate	<b>M239200</b>
	Opal screen in PMMA	<b>M239700</b>
	Prismoptic screen in polycarbonate	<b>M239600</b>

### With screen



### Screenless



Driver	Vac	L <sub>mm</sub>	W <sub>mm</sub>	H <sub>mm</sub>		Code
cc 50W 1400mA	220-240	165	43	30	1max	Undimmable <b>DV1015</b>
cc 50W 1400mA	220-240	153	41	32	1max	DALI 1-10 Push <b>DV1034</b>
cc 35W 700mA	220-240	103	67	21	1max	Undimmable <b>DV1017</b>
cc 35W 700mA	220-240	103	67	21	1max	DALI dimmable <b>M079200</b>
cc 35W 700mA	220-240	103	67	21	1max	1-10 Push <b>M079300</b>



Banca di Caraglio - Credito Cooperativo Caraglio (CN) - Italy  
Arch: Studio Kudra, Photo: Federico Villa



Centro Studi dello Studentato Universitario di Trento, Trento (Italy)  
Studio Palerm & Tabares de Nava S.L. Arquitectos, Photo: Federico Villa



Luceri LED trim



- White frame
- Grey frame
- Black frame

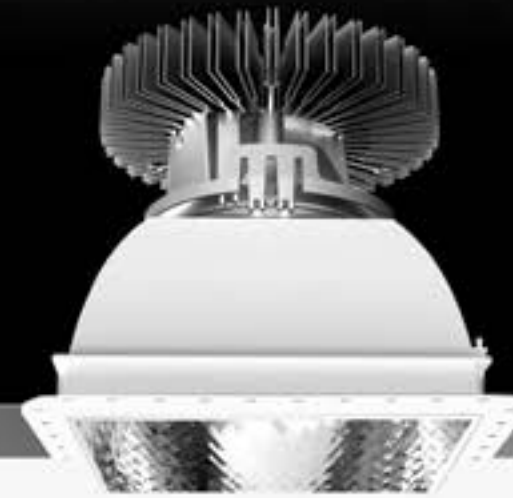

Luceri LED trimless

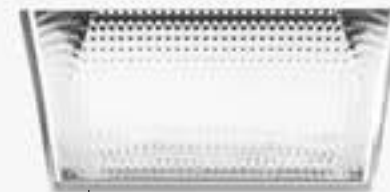

Sharp edge trim



Rounded edge trim

# Luceri

# ↪ Kadro

Recessed fixed downlighters using high-output LEDs.

Two versions: trim (with bezel) and Trimless (recessed ceiling mounted without bezel)

Materials: bezel, white reflector and screens in polycarbonate, reflectors in vacuum-metalled polycarbonate with anti-scratch surface treatment.

Standard version IP44.  
IP54 with the addition of an optional screen.

Compliant to standard EN60598-1, EN62471 and other specific standards.

## Luceri trim

Complete with optic housing and trim.  
Trim available in white, black or grey.

Professional mirror optic with UGR Luminance Control <19 for office spaces with computer screens.

Installation brackets for an easy, tool-free installation on false ceilings of thicknesses between 1 and 25 mm.

Optional screens in transparent polycarbonate, easy to install, opal and prismoptic diffuser, with a 90 degree turn.

Wide beam symmetrical distribution.

## Luceri trimless

2 available trims:  
Sharp edge  
Rounded edge

2 available optic housings.

Professional mirror optic with UGR Luminance Control <19 for office spaces with computer screens.

Comfort white optics.

Optics housings and trim to be ordered separately.

Optional screens in transparent polycarbonate, easy to install, opal and prismoptic diffuser, with a 90 degree turn.  
Wide beam symmetrical distribution.

## ↳ LUCERI KADRO TRIMLESS

White XF 220/240Vac 50/60Hz supplied separately. MacAdam 1SDCM Life L80 (10K) 55000h CRI= 90

▼ IP20 / ▲ IP44 screenless.  
▼ IP20 / ▲ IP54 with screen.

Fitting to be completed with installation frame.

### COMFORT WHITE OPTICS

Fixed white							Code
W	Weight	Beam	CCT	Driver Flux			
max 54 W	1,70 kg	69°	3000 K	50 W	3969 lm	<b>BB10300</b>	
				35 W	2279 lm		
				50 W	4232 lm		
				35 W	2438 lm		
Tunable white							<b>BB10400</b>
W	CRI	Weight	Beam	CCT	Flux		
17 W	=80	1,70 kg	60°	2700 K-	1381 lm	<b>BB10500</b>	
				6500 K	1596 lm		

**TW®**  
Artemide Tunable White

Tunable white							Code
W	CRI	Weight	Beam	CCT	Flux		
17 W	=80	1,70 kg	60°	2700 K-	1381 lm	<b>BB10500</b>	
				6500 K	1596 lm		

220/240Vac 50/60Hz electronic ballast included

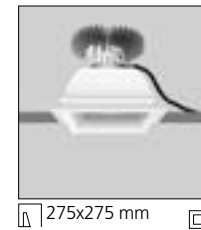
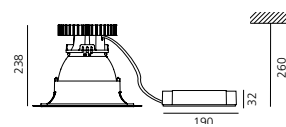
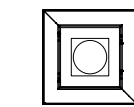
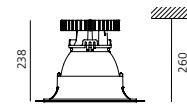
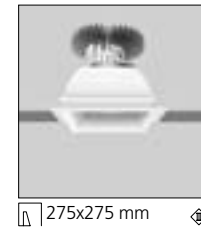

### FACETED MIRROR OPTICS

Fixed white							Code
W	Weight	Beam	CCT	Driver Flux			
max 54 W	1,70 kg	72°	3000 K	50 W	4388 lm	<b>BB11000</b>	
				35 W	2520 lm		
				50 W	4679 lm		
				35 W	2695 lm		

**TW®**  
Artemide Tunable White

Tunable white							Code
W	CRI	Weight	Beam	CCT	Flux		
16 W	=80	1,70 kg	56°	2700 K-	1530 lm	<b>BB11200</b>	
				6500 K	1770 lm		

220/240Vac 50/60Hz electronic ballast included

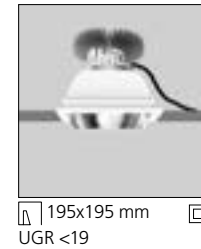
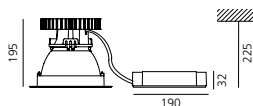
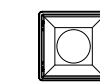
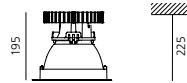
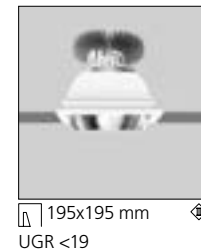

### Installation frame

		Code
	Sharp edge trim	<b>M240700</b>
	Support with rounded edge trim	<b>M240800</b>
	Accessory for ceiling installation	<b>M239920</b>

## ↳ LUCERI KADRO TRIM

White Black Grey XF 220/240Vac 50/60Hz supplied separately. MacAdam 1SDCM Life L80 (10K) 55000h CRI= 90

▼ IP20 / ▲ IP44 screenless.  
▼ IP20 / ▲ IP54 with screen.

### FACETED MIRROR OPTICS

Fixed white							Code
W	Weight	Beam	CCT	Driver Flux			
max 54 W	1,70 kg	72°	3000 K	50 W	4388 lm	<b>BB120.</b>	01/04 05
				35 W	2519 lm		
				50 W	4679 lm		
				35 W	2695 lm		
Tunable white							<b>BB121.</b>
W	CRI	Weight	Beam	CCT	Flux		
17 W	=80	1,70 kg	56°	2700 K-	1530 lm	<b>BB121.</b>	01/04 05
				6500 K	1770 lm		

**TW®**  
Artemide Tunable White

Tunable white							Code
W	CRI	Weight	Beam	CCT	Flux		
17 W	=80	1,70 kg	56°	2700 K-	1530 lm	<b>BB121.</b>	01/04 05
				6500 K	1770 lm		

220/240Vac 50/60Hz electronic ballast included

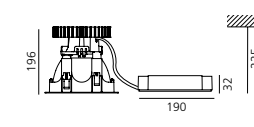
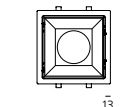
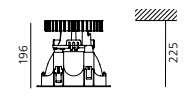

### Accessories

		Code
	Transparent screen in polycarbonate	<b>M239300</b>
	Opal screen in PMMA	<b>M239400</b>
	Prismoptic screen in polycarbonate	<b>M239500</b>

### With screen

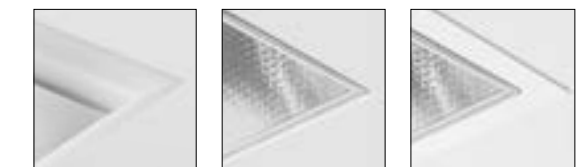

### Screenless

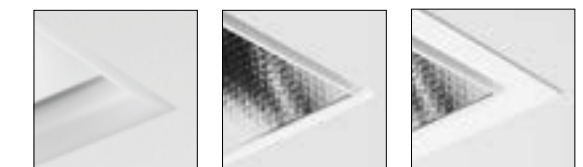

Driver	Vac	L <sub>mm</sub>	W <sub>mm</sub>	H <sub>mm</sub>			Code
cc 50W 1400mA	220-240	165	43	30	1max	Undimmable	<b>DV1015</b>
cc 50W 1400mA	220-240	153	41	32	1max	DALI 1-10 Push	<b>DV1034</b>
cc 35W 700mA	220-240	103	67	21	1max	Undimmable	<b>DV1017</b>
cc 35W 700mA	220-240	103	67	21	1max	DALI dimmable	<b>M079200</b>
cc 35W 700mA	220-240	103	67	21	1max	1-10 Push	<b>M079300</b>



## ↪ PICTO RECESSED

White 01	Silver 05	F	WF	Driver 1200mA SELV supplied separately.	MacAdam 3SDCM Life L70 (6K) 50000h CRI =90	IP20
-------------	--------------	---	----	--	--	------



Picto Recessed				Code
W	Beam	Flux	CCT	
41 W	F 18°	3773 lm	3000K	<b>AD601.</b> 01/05
		3851 lm	4000K	<b>AD641.</b> 01/05
	WF 40°	3757 lm	3000K	<b>AD602.</b> 01/05
		3835 lm	4000K	<b>AD642.</b> 01/05



∅ 165 mm

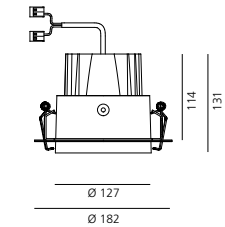

Picto Recessed High Flux				Code
W	Beam	Flux	CCT	
60 W	F 17°	5507 lm	3000K	<b>AD603.</b> 01/05
		5672 lm	4000K	<b>AD643.</b> 01/05
	WF 41°	5515 lm	3000K	<b>AD604.</b> 01/05
		5680 lm	4000K	<b>AD644.</b> 01/05

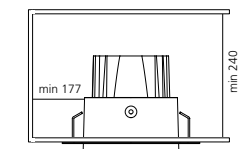
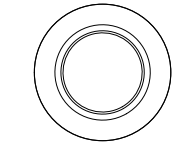

Driver	Vac	L <sub>mm</sub>	W <sub>mm</sub>	H <sub>mm</sub>		Code
cc 50W 1200mA	220-240	152	81	30	1max	Undimmable <b>DV1012</b>
cc 50W 1200mA	220-240	152	81	30	1max	DALI dimmable <b>DV1011</b>
cc 70W 1200mA	220-240	171	81	30	1max	Undimmable <b>DV1014</b>
cc 70W 1200mA	220-240	171	81	30	1max	DALI dimmable <b>DV1013</b>

# Picto Recessed

Studio Artemide

↪ 2018

Set of fixed recessed downlight equipment using high efficiency LEDs

Available in one dimension with two different power ratings, each with two opening angles of the light beam (flood and wide flood).

Dali dimmable or non dimmable driver not included.

Available in two finishes: painted white or silver.

Technical features of the equipment compliant with EN60598-1.

ENEC certification.



For further information on Picto recessed  
↪ visit [artemide.com](http://artemide.com)



# Parabola

↪ 2010

Light fixture with high-performance LED light sources.  
Consists of: frame, body, lens, fixing springs.  
Frame in injection mould of aluminium.  
Heat sink body in extruded aluminium.  
Lens in polycarbonate with 3 different versions of beam.

Fixing springs in harmonic steel.  
Electrical connection to the driver by means of a FEP-FEP cable and a terminal board.  
Technical features of light fixtures in compliance with EN60598-1.



For further information on Parabola  
↪ visit [artemide.com](http://artemide.com)

## ↳ PARABOLA 80

White Black Silver XF

06 04 02

Driver 350 mA SELV supplied separately.

MacAdam 3SDCM  
 Life L70 (6K) > 60000h  
 CRI = 90

IP40

Round					Fixed	
W	Weight	Beam	Flux	CCT	Code	
12 W	0,28 kg	XF 52°	1095 lm	2700 K	<b>NL1906340Y0.06/04/02</b>	
			1145 lm	3000 K	<b>NL1906340K0.06/04/02</b>	
			1139 lm	3000 K	<b>NL1906360K0.06/04/02</b>	
		XF 64°	1090 lm	2700 K	<b>NL1906360Y0.06/04/02</b>	
			1139 lm	3000 K	<b>NL1906380Y0.06/04/02</b>	
			1181 lm	3000 K	<b>NL1906380K0.06/04/02</b>	

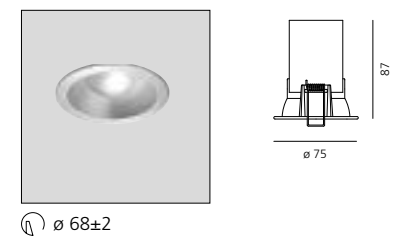

Round					Adjustable	
W	Weight	Beam	Flux	CCT	Code	
12 W	0,28 kg	XF 52°	1095 lm	2700 K	<b>NL1906440Y0.06/04/02</b>	
			1145 lm	3000 K	<b>NL1906440K0.06/04/02</b>	
			1139 lm	3000 K	<b>NL1906460K0.06/04/02</b>	
		XF 64°	1090 lm	2700 K	<b>NL1906460Y0.06/04/02</b>	
			1139 lm	3000 K	<b>NL1906480Y0.06/04/02</b>	
			1181 lm	3000 K	<b>NL1906480K0.06/04/02</b>	

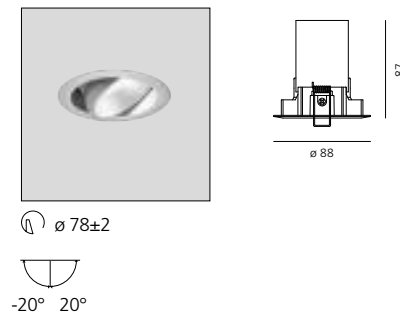

Square					Fixed	
W	Weight	Beam	Flux	CCT	Code	
12 W	0,28 kg	XF 52°	1095 lm	2700 K	<b>NL1907140Y0.06/04/02</b>	
			1145 lm	3000 K	<b>NL1907140K0.06/04/02</b>	
			1139 lm	3000 K	<b>NL1907160K0.06/04/02</b>	
		XF 64°	1090 lm	2700 K	<b>NL1907160Y0.06/04/02</b>	
			1139 lm	3000 K	<b>NL1907180Y0.06/04/02</b>	
			1181 lm	3000 K	<b>NL1907180K0.06/04/02</b>	

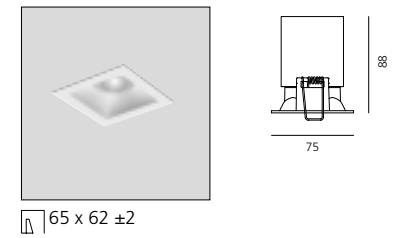

Driver	Vac	L <sub>mm</sub>	W <sub>mm</sub>	H <sub>mm</sub>	n°device	Code
cc 15W 350mA	220-240	156	52	26	1 max	Undimmable <b>M077500</b>
cc 16W 350mA	220-240	156	52	26	1 max	DALI/PUSH/0-10V dimmable <b>M077401</b>
cc 19W 350mA	220-240	164	38	25	1 max	DALI/PUSH dimmable <b>DV1003</b>

## ↳ PARABOLA 100

White Black Silver XF

06 04 02

Driver 500 mA SELV supplied separately.

MacAdam 3SDCM  
 Life L70 (6K) > 60000h  
 CRI = 90

IP40

Round					Fixed	
W	Weight	Beam	Flux	CCT	Code	
17 W	0,50 kg	XF 50°	1493 lm	2700 K	<b>NL1907240Y0.06/04/02</b>	
			1560 lm	3000 K	<b>NL1907240K0.06/04/02</b>	
			1533 lm	3000 K	<b>NL1907260K0.06/04/02</b>	
		XF 64°	1467 lm	2700 K	<b>NL1907260Y0.06/04/02</b>	
			1477 lm	2700 K	<b>NL1907280Y0.06/04/02</b>	
			1544 lm	3000 K	<b>NL1907280K0.06/04/02</b>	

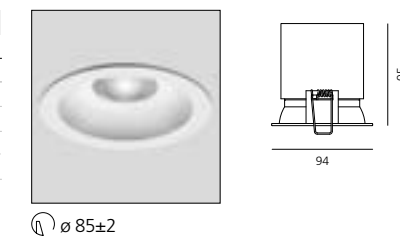

Round					Adjustable	
W	Weight	Beam	Flux	CCT	Code	
17 W	0,50 kg	XF 50°	1493 lm	2700 K	<b>NL1907440Y0.06/04/02</b>	
			1560 lm	3000 K	<b>NL1907440K0.06/04/02</b>	
			1533 lm	3000 K	<b>NL1907460K0.06/04/02</b>	
		XF 64°	1467 lm	2700 K	<b>NL1907460Y0.06/04/02</b>	
			1477 lm	2700 K	<b>NL1907480Y0.06/04/02</b>	
			1544 lm	3000 K	<b>NL1907480K0.06/04/02</b>	

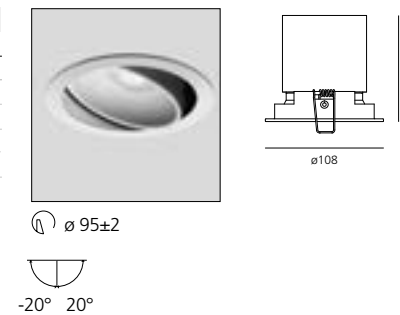

Square					Fixed	
W	Weight	Beam	Flux	CCT	Code	
17 W	0,50 kg	XF 50°	1493 lm	2700 K	<b>NL1907340Y0.06/04/02</b>	
			1560 lm	3000 K	<b>NL1907340K0.06/04/02</b>	
			1533 lm	3000 K	<b>NL1907360K0.06/04/02</b>	
		XF 64°	1467 lm	2700 K	<b>NL1907360Y0.06/04/02</b>	
			1477 lm	2700 K	<b>NL1907380Y0.06/04/02</b>	
			1544 lm	3000 K	<b>NL1907380K0.06/04/02</b>	

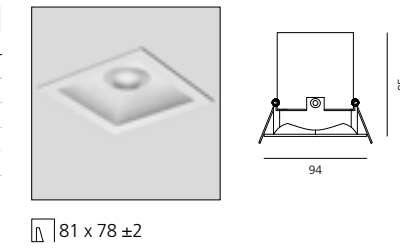

Driver	Vac	L <sub>mm</sub>	W <sub>mm</sub>	H <sub>mm</sub>	n°device	Code
cc 20W 500mA	220-240	125	38	23	1 max	Undimmable <b>M077600</b>
cc 25W 500mA	220-240	156	52	26	1 max	DALI/PUSH/0-10V dimmable <b>M077401</b>
cc 25W 500mA	220-240	164	38	25	1 max	DALI/PUSH dimmable <b>DV1003</b>





Le Roland Garros Restaurant, Paris - FR



Ibis Hotel, Heilbronn - DE



For further information on Rastaf  
↳ visit [artemide.com](http://artemide.com)



# Rastaf



Studio Artemide

↳ 2000



Series of LED recessed luminaires.  
Fixed and adjustable versions available.  
No accessories needed in the IP44 fixed version (IP44 from below)  
Tilt angle up to 45°.  
White steel recessing plate available separately, for 2 or 3 downlighters.  
Range of recessing accessories available.  
Separate power supply.  
Compliant with EN60598-1 standard and other specific standards.

↪ RASTAF

White 	F 	WF 	Driver 350 mA SELV supplied separately.	MacAdam 3SDCM Life L70 (6K) 50000h CRI =90	▼ IP20 / ▲ IP44 ⌀ 72 mm
--	--	---	--	--	-------------------------------

Fixed optic					Code
W	Weight	Beam	Flux	CCT	
12 W	0,32 kg	F 20°	391 lm	2700 K	<b>M038200</b>
			408 lm	3000 K	<b>M038500</b>
		WF 32°	311 lm	2700 K	<b>M038300</b>
			324 lm	3000 K	<b>M038700</b>

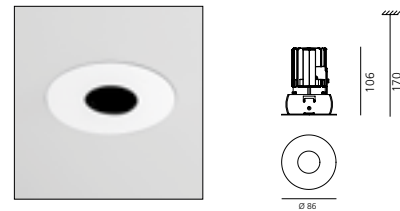

Adjustable optic					Code
W	Weight	Beam	Flux	CCT	
12 W	0,32 kg	F 20°	391 lm	2700 K	<b>M038205</b>
			408 lm	3000 K	<b>M038505</b>
		WF 32°	311 lm	2700 K	<b>M038305</b>
			324 lm	3000 K	<b>M038705</b>

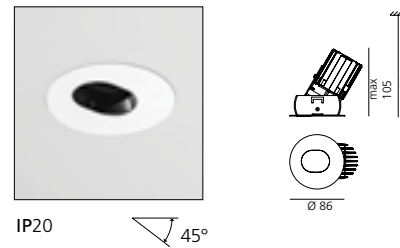



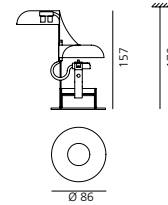

LED (GU10)		Fix
Weight	Code	
230-240V	0,15 kg	<b>M047900</b>

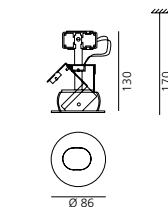

Adjustable	
Code	
<b>M047905</b>	



Accessories		Code	Code
	Recessing ring for mineral fiber false ceilings for Rastaf 86 fixed or adjustable. ⌀ 78 mm	<b>M080018</b>	<b>M017300</b>
	Aluminium recessing ring for Rastaf 86 fixed or adjustable. ⌀ 78 mm	<b>M080028</b>	
	Steel recessing ring with springs for plasterboard false ceilings for Rastaf 86 fixed or adjustable.	<b>M080038</b>	<b>M017400</b>
	Steel recessing plate for 2 spots for Rastaf 86 fixed or adjustable. ⌀ 86 mm, 125 mm, 275 mm, 260x 78 mm		
	Steel recessing plate for 3 spots for Rastaf 86 fixed or adjustable. ⌀ 86 mm, 125 mm, 425 mm, 410x 78 mm		

Driver	Vac	L <sub>mm</sub>	W <sub>mm</sub>	H <sub>mm</sub>	Code			
cc 15W	350mA	220-240	125	38	23	1max	Non dimmable	<b>M077500</b>
cc 16W	350mA	220-240	156	52	26	1max	DALI/PUSH/0-10V dimmable	<b>M077401</b>

Ristorante Larte - Milano (Italy)  
 Interior project: Lorenzo Morganti, Grishoni Service  
 Photo: Federico Villa

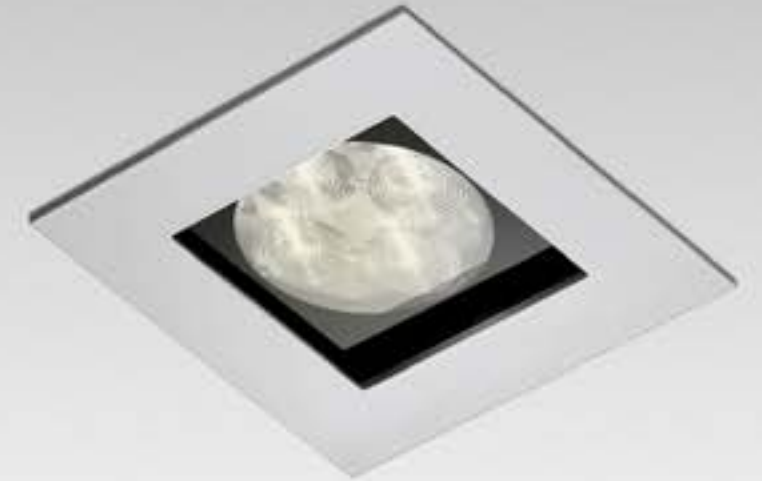
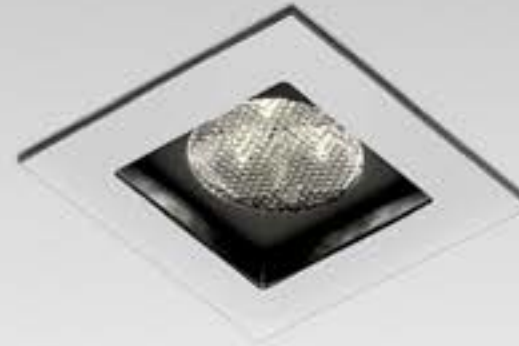

# Zeno Up

Jan Van Lierde

↪ 2011

Light fixture with high-performance LED light sources.

Low recessed depth.

Consists of: body, frame, black silkscreened tempered glass, fixing springs.

Body in EN AB44100 aluminium, silicone gaskets.

Frame in aluminium.

Black silkscreened tempered glass, 4mm-thick.

Fixing springs in harmonic steel.

Power connection to the mains by means of a H05RN-r cable and IP68 electrical terminal board, supplied with the fixture.



For further information on Zeno Up  
↪ visit [artemide.com](http://artemide.com)

Glass surface temperature lower than 40°C.

Fixed optics. PMMA lenses in 2 different versions of beams.

Painted die-cast aluminium with 3-stage outdoor treatment: nanotechnologies, antioxydant primer, polyester paint.

Technical features of light fixtures in compliance with EN60598-1.



**Artemide  
App**

↪ on request  
Only for Zeno Up 4



Yacht San Lorenzo SL104

## ↪ ZENO UP

White 06	Silver 02	Chrome 03	S	F	Driver 500/700mA supplied separately.	MacAdam4SDCM Life L70 (6K) 39300h CRI =80	IP65 CE
-------------	--------------	--------------	---	---	--	---	------------

### ZENO UP 2

W	Weight	Beam	Flux	CCT	Code
2 W	0,12 kg	S 13°	128 lm	3000 K	NL1708410K0.06/02
		F 24°	133 lm	3000 K	NL1708425K0.06/02

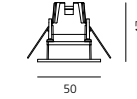

38 x 36

Driver	Vac	L <sub>mm</sub>	W <sub>mm</sub>	H <sub>mm</sub>	IP	n°device	Code
cc 14W	700mA	220-240	79	38	25	67 1-5max	Undimmable DV3003
cc 10W	700mA	220-240	75	38	25	20 1-4max	Undimmable NL19035
cc 25W	700mA	220-240	164	38	25	20 1-9max	DALI/PUSH dimmable DV1003
cc 38W	700mA	220-240	185	35	33	67 1-12max	DALI DV1042
*cc 28W	700mA	220-240	156	52	26	20 1-7max	DALI/PUSH/1-10V/0-10V dimmable *M077401

\*Verify driver / recessed hole's dimensions.

### ZENO UP 3

W	Weight	Beam	Flux	CCT	Code
5 W	0,21 kg	S 16°	269 lm	3000 K	NL1708510K0.06/02/03
		F 24°	280 lm	3000 K	NL1708525K0.06/02/03

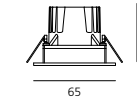

52 x 56

Driver	Vac	L <sub>mm</sub>	W <sub>mm</sub>	H <sub>mm</sub>	IP	n°device	Code
cc 14W	500mA	220-240	79	38	25	67 1-2max	Undimmable DV3002
cc 28W	500mA	220-240	120	38	25	67 3-4max	Undimmable DV1039
cc 10W	500mA	220-240	22	110	19	27 1max	Undimmable NL10941
cc 25W	500mA	220-240	164	38	25	20 1-4max	DALI/PUSH dimmable DV1003
cc 28W	500mA	220-240	185	35	33	67 1-4max	DALI DV1042
*cc 20W	500mA	220-240	156	52	26	20 1-4max	DALI/PUSH/1-10V/0-10V dimmable *M077401

\*Verify driver / recessed hole's dimensions.

### ZENO UP 4

W	Weight	Beam	Flux	CCT	Code
6,5 W	0,34 kg	S 10°	364 lm	3000 K	NL1708610K0.06/02/03
		F 30°	376 lm	3000 K	NL1708625K0.06/02/03

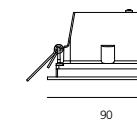

79 x 79

Driver	Vac	L <sub>mm</sub>	W <sub>mm</sub>	H <sub>mm</sub>	IP	n°device	Code
cc 14W	500mA	220-240	79	38	25	67 1-2max	Undimmable DV3002
cc 28W	500mA	220-240	120	38	25	67 3-4max	Undimmable DV1039
cc 10W	500mA	220-240	22	110	19	27 1max	Undimmable NL10941
cc 25W	500mA	220-240	164	38	25	20 1-4max	DALI/PUSH dimmable DV1003
cc 28W	500mA	220-240	185	35	33	67 1-3max	DALI DV1042
*cc 20W	500mA	220-240	156	52	26	20 1-4max	DALI/PUSH/1-10V/0-10V dimmable *M077401

\*Verify driver / recessed hole's dimensions.

## ↳ ZENO UP FROSTED

White



XF



Driver 500/700mA  
supplied separately.

MacAdam 4SDCM  
Life L70 (6K)> 39300h  
CRI = 80

IP40  
CE



### ZENO UP 4 FROSTED

W	CRI	Weight	Beam	Flux	CCT	Code
10 W	=80	0,30 kg	XF	464 lm	3000K	<b>NL17092K0</b>

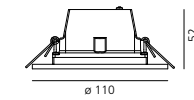
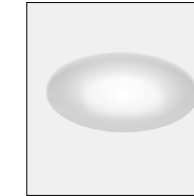

Ø103

Driver	Vac	L <sub>mm</sub>	W <sub>mm</sub>	H <sub>mm</sub>	IP	n°device	Code
cc 20W	700mA	220-240	125	38	23	20 1max	Undimmable <b>NL19036</b>
cc 25W	700mA	220-240	164	38	25	20 1-2max	DALI/PUSH dimmable <b>DV1003</b>
cc 28W	700mA	220-240	156	52	26	20 1-2max	DALI/PUSH/1-10V/0-10V dimmable <b>M077401</b>

### ZENO UP 3 FROSTED

W	CRI	Weight	Beam	Flux	CCT	Code
5 W	=80	0,30 kg	XF	138 lm	3000K	<b>NL17090K0</b>

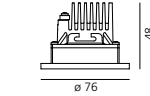
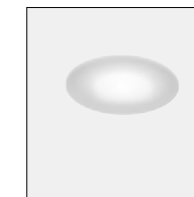

Ø70

Driver	Vac	L <sub>mm</sub>	W <sub>mm</sub>	H <sub>mm</sub>	IP	n°device	Code
cc 10W	500mA	220-240	22	110	19	20 1max	Undimmable <b>NL10941</b>
cc 25W	500mA	220-240	164	38	25	20 1-2max	DALI/PUSH dimmable <b>DV1003</b>
cc 28W	500mA	220-240	156	52	26	20 1-2max	DALI/PUSH/1-10V/0-10V dimmable <b>M077401</b>

# Zeno Up Frosted

Jan Van Lierde

↳ 2011

Light fixture with high-performance LED light sources.

Consists of: frame, body, fixing springs.

Frame in frosted opal glass, 4mm thick.

Body in injection mould of aluminium.

Fixing springs in harmonic steel.

Electrical connection to the driver by means of a FROR cable and a terminal board.

Technical features of light fixtures in compliance with EN60598-1.



For further information on Zeno Up Frosted  
↳ visit [artemide.com](http://artemide.com)



# Professional Lighting

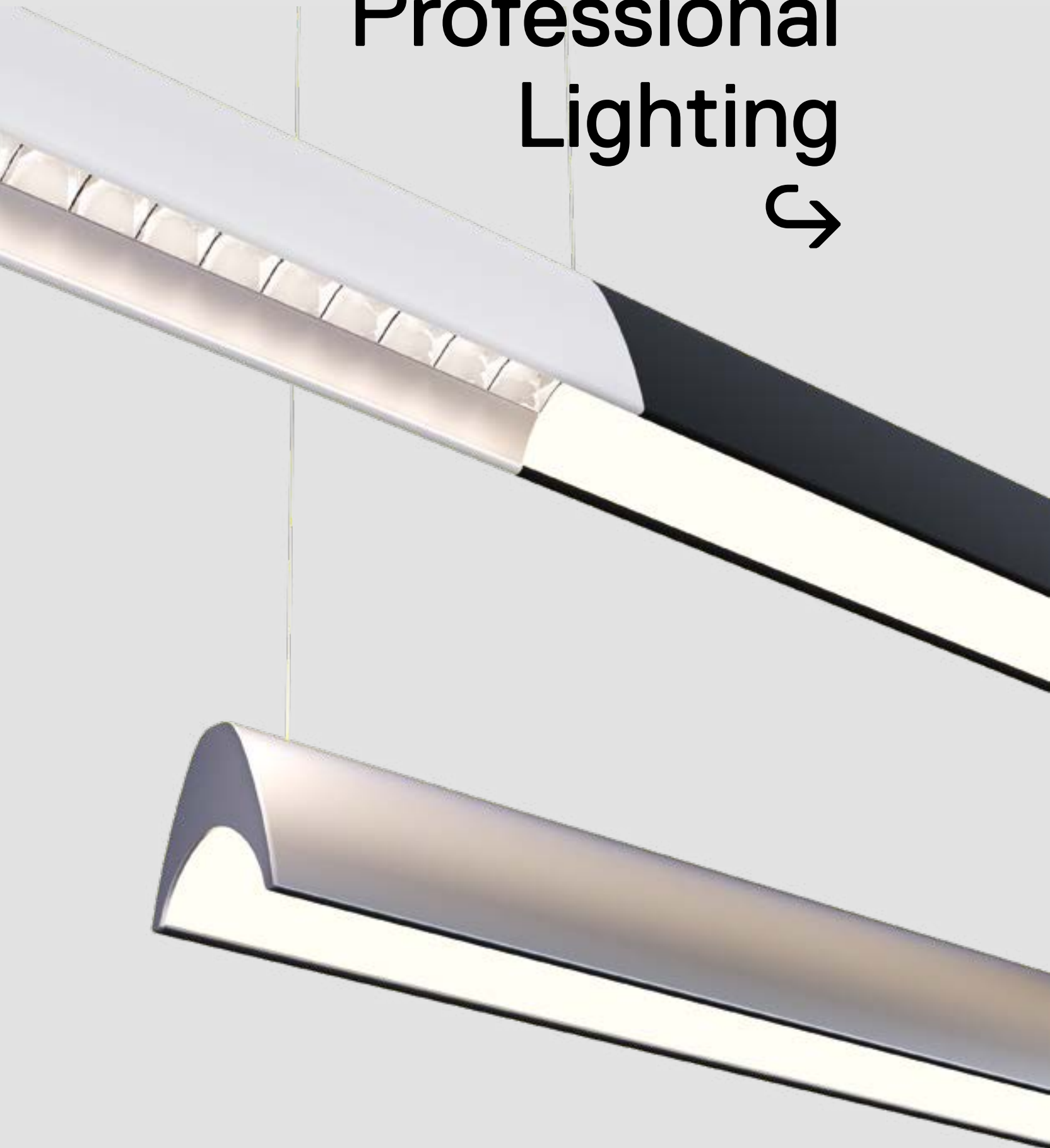

A.24 _____	298	
A.39 _____	368	
Algoritmo _____	408	
Smart Office _____		458
Series Y _____	464	
Calipso _____	486	
Grafa System _____		504
Pad System _____		516
Uglare 19 _____	522	
Chocolate Floor _____		524
Chocolate _____	530	
Surf System _____		532
Surf Wall _____	538	
Eggboard _____	540	
Silent Field 2.0 _____	566	
Nur 1618 Acoustic _____		572

# A.24 is a fluid system

Carlotta de Bevilacqua  
↳ 2017



For further information on A.24  
↳ visit [artemide.com](http://artemide.com)

→ PATENT PENDING





# A.24 System typologies



**90° ANGLE MAGNETIC**  
301 x 301 mm



**90° ANGLE DIFFUSED**  
301 x 301 mm



**90° ANGLE SHARPING**  
301 x 301 mm



**CIRCULAR DIFFUSED**  
RADIUS 561 mm (60° - 90°)  
RADIUS 750 mm (45° - 90°)

**CIRCULAR SHARPING**  
RADIUS 561 mm (60° - 90°)  
RADIUS 750 mm (45° - 90°)

**CIRCULAR MAGNETIC**  
RADIUS 561 mm (60° - 90°)  
RADIUS 750 mm (45° - 90°)



**LINEAR MAGNETIC TRACK**  
1176 - 2352 mm



**LINEAR DIFFUSED**  
1176 - 2352 mm



**LINEAR SHARPING**  
1176 - 2352 mm

# A.24 Stand-alone typologies

LINEAR MAGNETIC TRACK  
1176 - 2352 mm



LINEAR DIFFUSED  
1176 - 2352 mm



LINEAR SHARPING  
1176 - 2352 mm



CIRCULAR SHARPING  
Ø 1122 mm  
Ø 1500 mm

CIRCULAR DIFFUSED  
Ø 1122 mm  
Ø 1500 mm

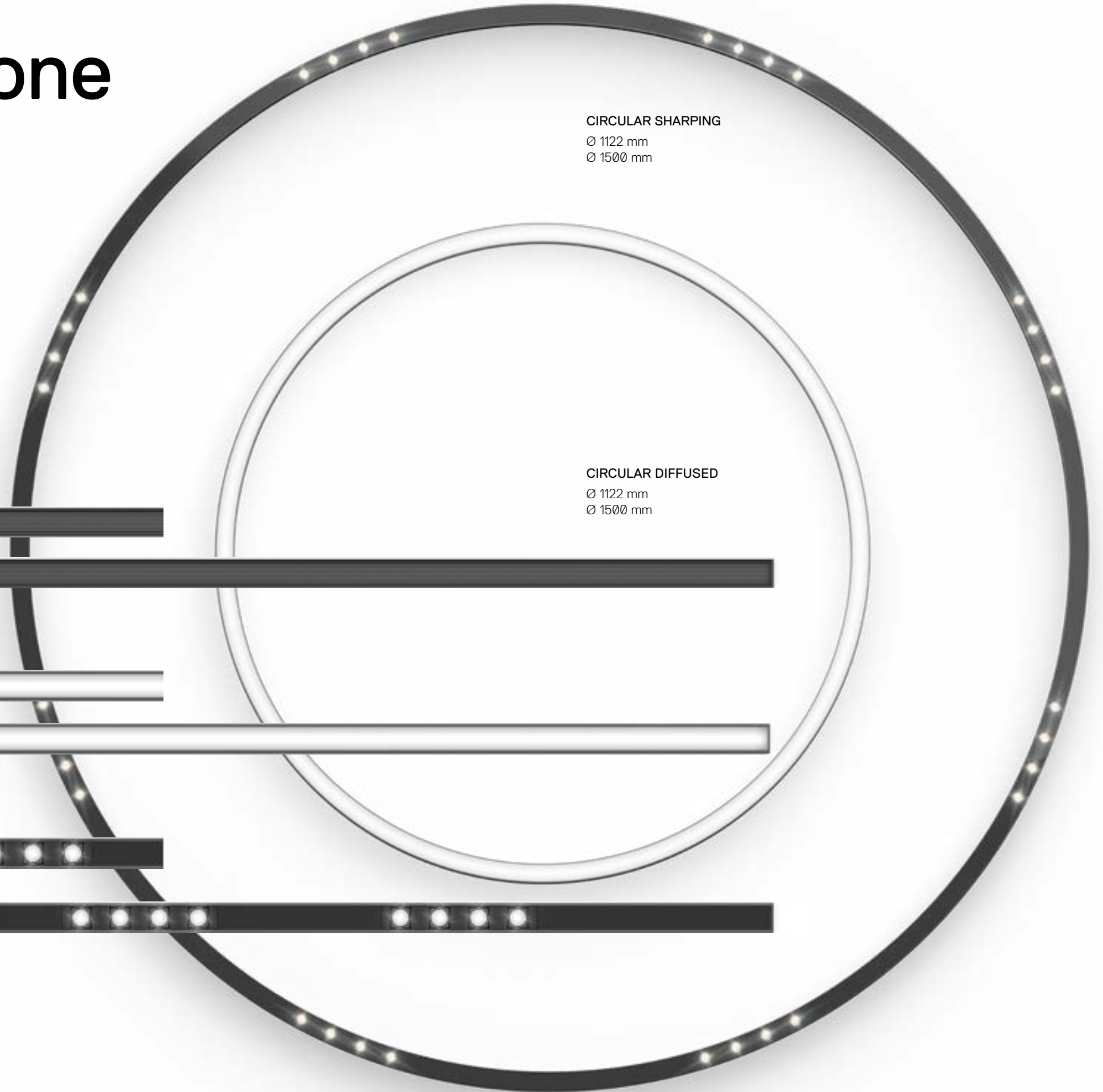



# A.24/ Vector colors

White



01



Black



04



Bronze



20



Brushed Copper



18



Brushed Silver



15



→ Fast delivery

→ Delivery time on demand

# A.24

## color temperatures



→ Fast delivery



→ Delivery time on demand



# A.24 is fully addressable

Each module and spot can be managed separately by Artemide App or by DALI control up to 64 IP Address



16W / 33W  
MacAdam 2SDC  
CRI=80  
CCT: 2700K / 3000K / 4000K



10W  
MacAdam 3SDC  
CRI=90  
CCT: 2700K / 3000K / 4000K

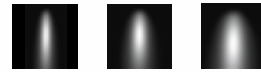

S 13° 540 lm  
F 20° 584 lm  
WF 28° 528 lm

26W  
MacAdam 3SDC  
CRI=90  
CCT: 2700K / 3000K / 4000K

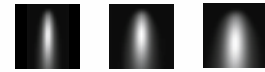

S 16° 1492 lm  
F 22° 1465 lm  
WF 32° 1596 lm

23W  
MacAdam 3SDC  
CRI=90  
CCT: 2700K / 3000K / 4000K

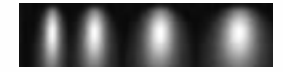

S 22° 660 lm → WF 32° 1137 lm

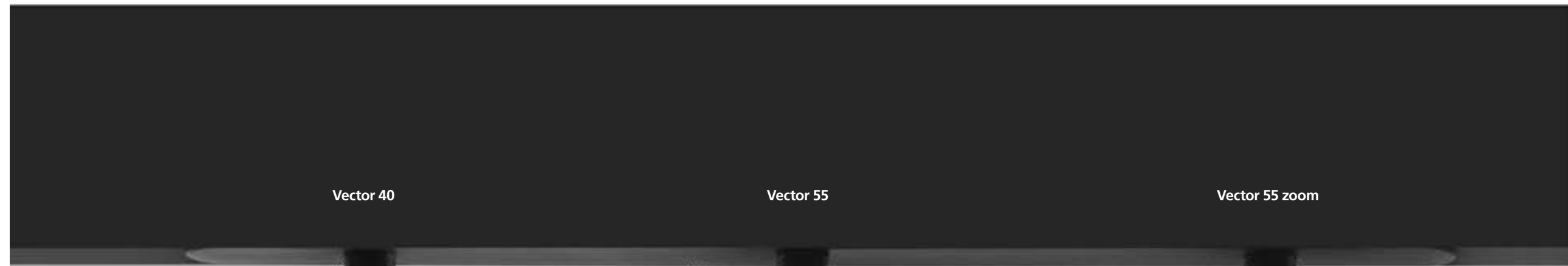

Vector 40

Vector 55

Vector 55 zoom



A.24  
↪ Magnetic



# A.24 Magnetic is Artemide SELV

a unique feature developed for a real  
safe DALI interface.



D.art® is a technology patented by Artemide that overcomes the safety limits of the DALI signal in devices where the same signal is accessible to the touch.

The DALI signal is transformed to an “SELV” voltage ensuring the total safety of the appliance.

A.24 has been designed in compliance with international certifications.



16W / 33W  
MacAdam 2SDC  
CRI=80  
CCT: 2700K / 3000K / 4000K

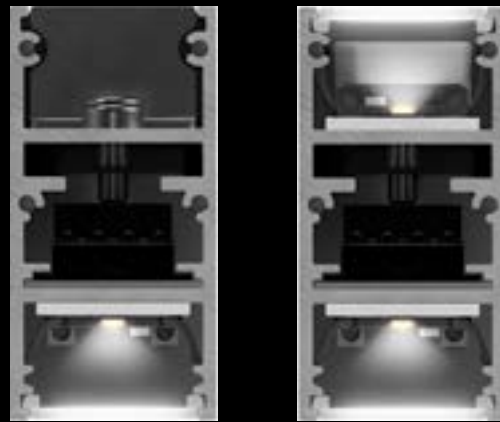

33W / 66W  
MacAdam 2SDC  
CRI=80  
CCT: 2700K / 3000K / 4000K



# A.24 Diffused



16W / 33W  
MacAdam 2SDC  
CRI=80  
CCT: 2700K / 3000K / 4000K

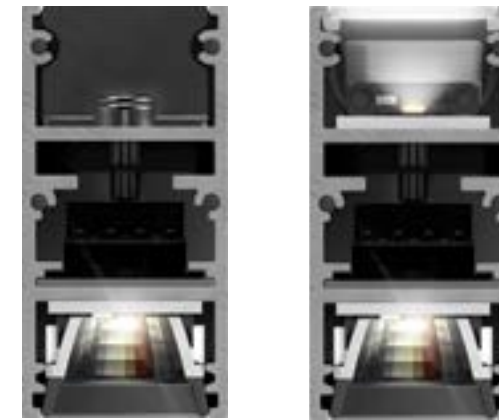

MacAdam 2SDC  
CRI=90  
CCT: 2700K / 3000K / 4000K



22W S 24°    22W XF 62°    46W S 24°    46W XF 62°

# A.24 Sharping

RECESSED  
TRIMLESS

CEILING

SUSPENSION

SUSPENSION WITH  
INDIRECT EMISSION

# A.24 space fittings

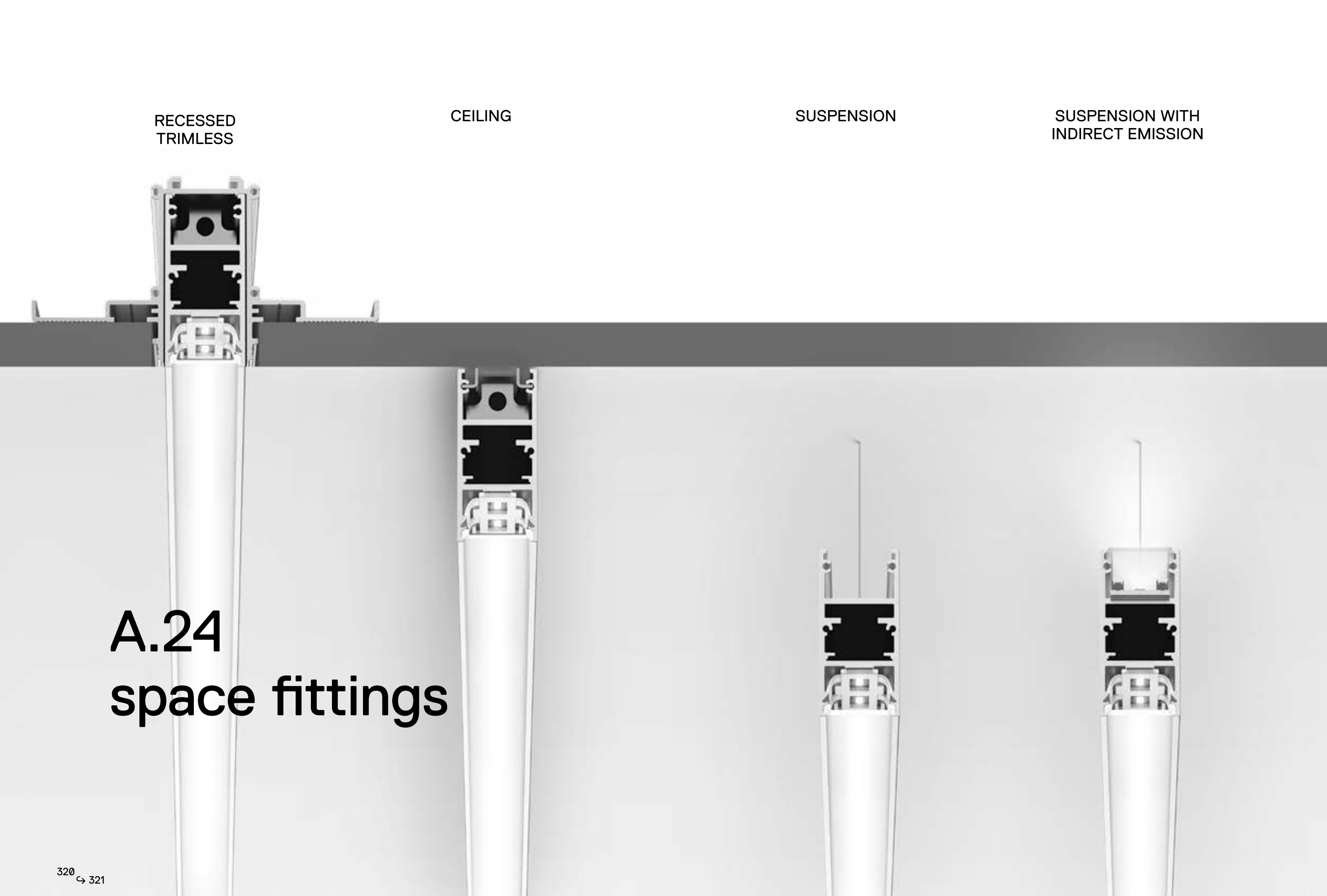

# A.24 is balanced



NO TRACK'S ROTATION WHEN THE SPOTLIGHTS ARE TILTED IN THE SAME DIRECTION.  
SUSPENSION CABLE NO STIFF STEMS.

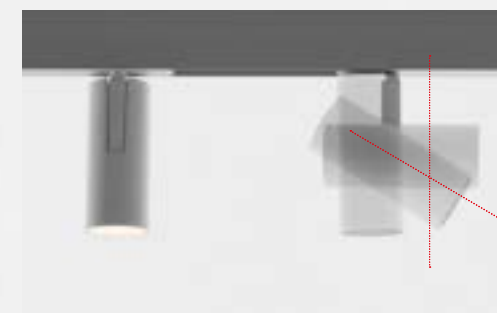

The junction arm is integrated with the spotlight body.

The center of balance is perfectly aligned with the track.

The pivoting and arm orientation are lockable.

# A.24 / Vector infinite possibilities

- 1. A.24 Recessed diffused emission
- 2. Vector 40 magnetic
- 3. Vector 55 magnetic
- 4. A.24 Ceiling - wall diffused emission
- 5. A.24 Suspension sharpening emission 24°
- 6. A.24 Suspension diffused emission
- 7. A.24 Suspension sharpening emission 64°
- 8. Vector 55 zoom magnetic
- 9. Vector 40 /Unterlinden magnetic pendant
- 10. A.24 Suspension indirect diffused emission

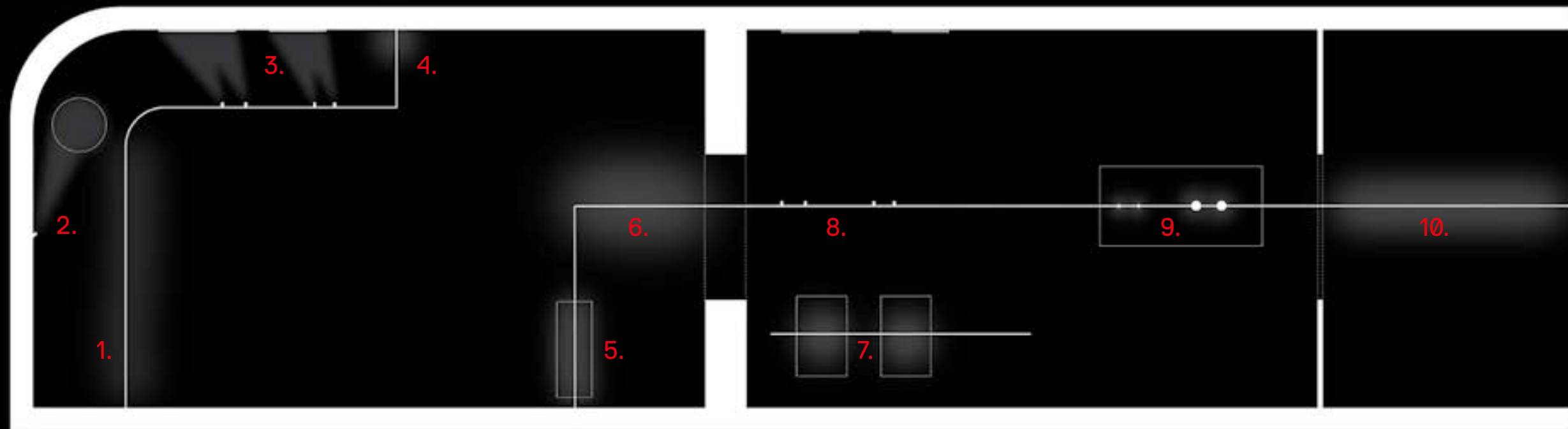
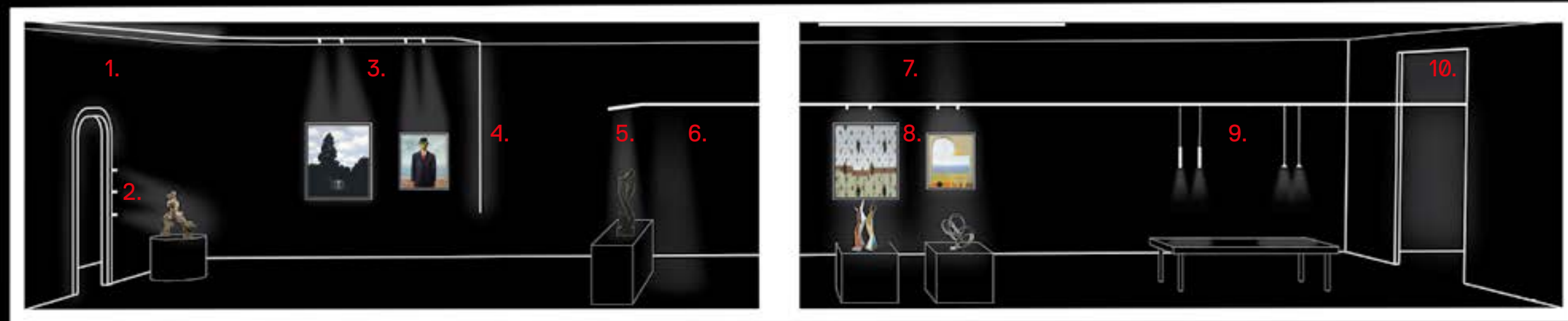

# A.24

## pre-configured modules

Each module (magnetic track, diffused, sharpening) is pre-configured and it is provided with:

- Ø1. the specific optical engine (magnetic, diffused, sharpening).
- Ø2. the mechanical and electrical connections to combine for a continuous run.
- Ø3. each suspension module is equipped with a suspension cable.
- Ø4. each ceiling module is equipped with 1 ceiling bracket for 1176 mm length or with 2 ceiling brackets for 2352 mm length.

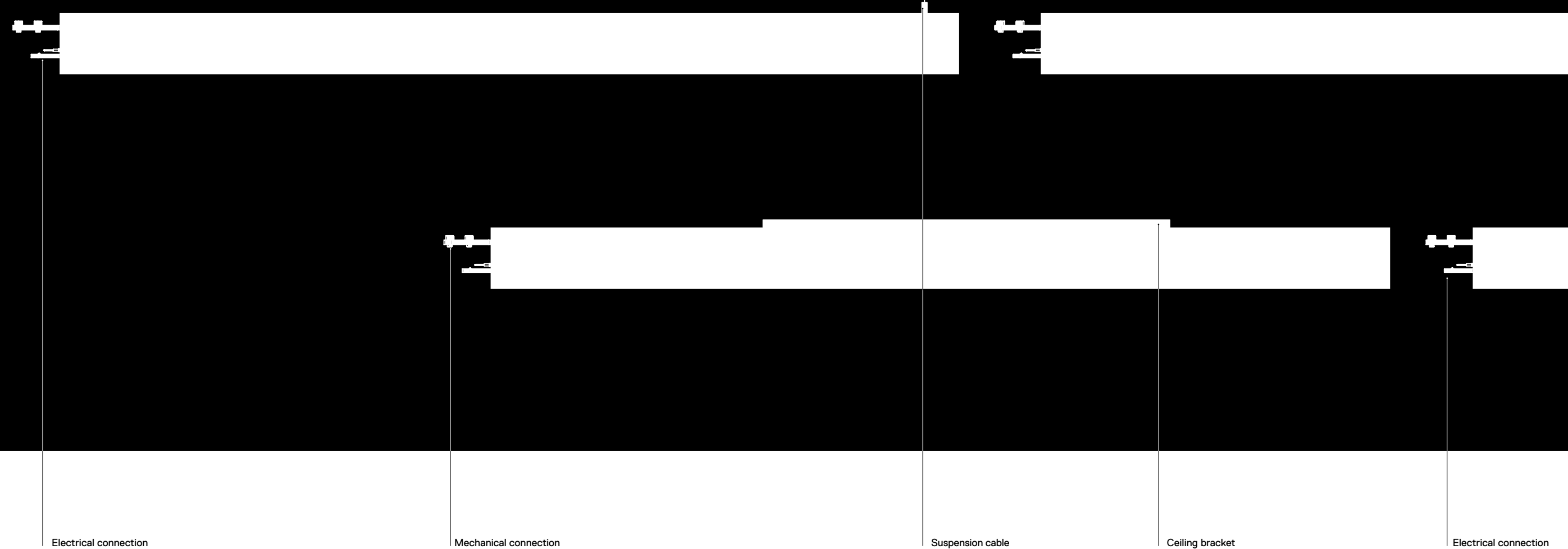

# A.24 components

MAGNETIC TRACK

FEEDING CABLES CAN BE LOCATED EVERYWHERE, INCLUDING CORNERS. TRACK ANGLED ELEMENTS CAN INDEPENDENTLY FEED EACH ARMS.

USE INSULATING SPACERS WHEN USING SEVERAL POWERSUPPLY KITS.

DIFFUSING AND JOINING ANGLED ELEMENTS FEED BOTH ARMS TOGETHER.

DIFFUSED

SHARPING

TRANSITION COMPONENT WHEN PASSING FROM ONE TECHNOLOGY TO A DIFFERENT ONE.

# A.24 is powered by 48 Vdc

It permits long runs  
in a small size 27x54 mm



## MAGNETIC

### VECTOR 40

max 12 with 1 Power Supply 150W - effective 125W  
max 21 with 1 Power Supply 240W - effective 210W

### VECTOR 55

max 4 with 1 Power Supply 150W - effective 125W  
max 8 with 1 Power Supply 240W - effective 210W

## DIFFUSED

### DIRECT

max 4m with 1 Power Supply 150W - effective 125W  
max 7m with 1 Power Supply 240W - effective 210W

### DIRECT-INDIRECT

max 2m with 1 Power Supply 150W - effective 125W  
max 4m with 1 Power Supply 240W - effective 210W

## SHARPING

### DIRECT

max 5m with 1 Power Supply 150W - effective 125W  
max 9m with 1 Power Supply 240W - effective 210W

### DIRECT-INDIRECT

max 3m with 1 Power Supply 150W - effective 125W  
max 5m with 1 Power Supply 240W - effective 210W



# A.24

## power supply

CEILING  
POWER SUPPLY  
240W - 150W

RECESSED  
POWER SUPPLY  
240W - 150W

REMOTE BARE  
POWER SUPPLY  
240W - 150W  
  
REMOTE BOX  
POWER SUPPLY  
240W - 150W

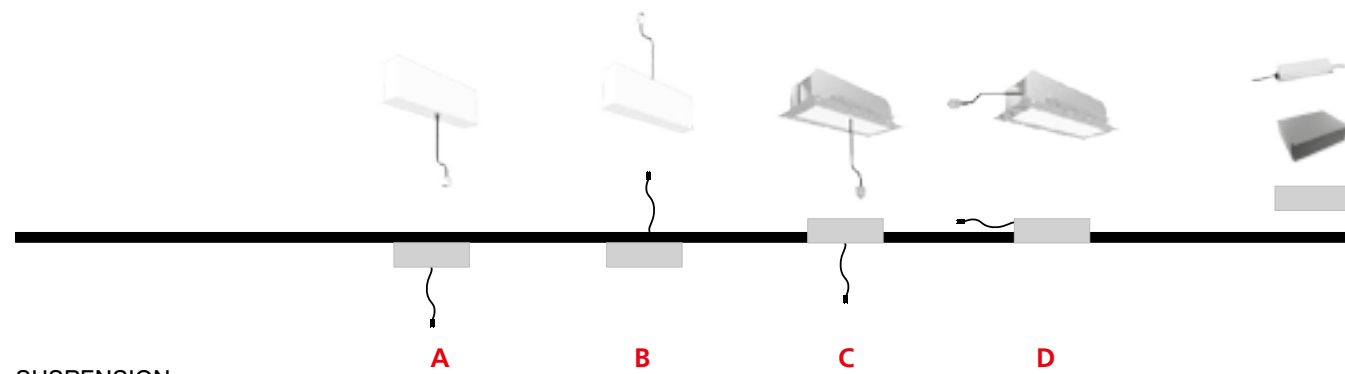

SUSPENSION

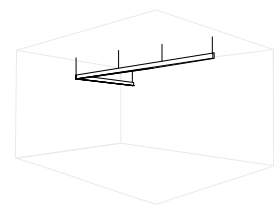

SMD

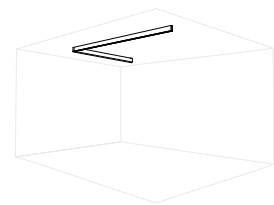

RECESSED

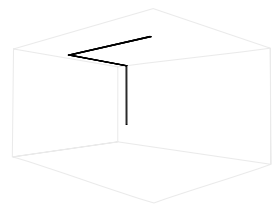

	<b>A</b>	<b>B</b>	<b>C</b>	<b>D</b>
SUSPENSION	●		●	●
SMD		●	●	●
RECESSED		●	●	●

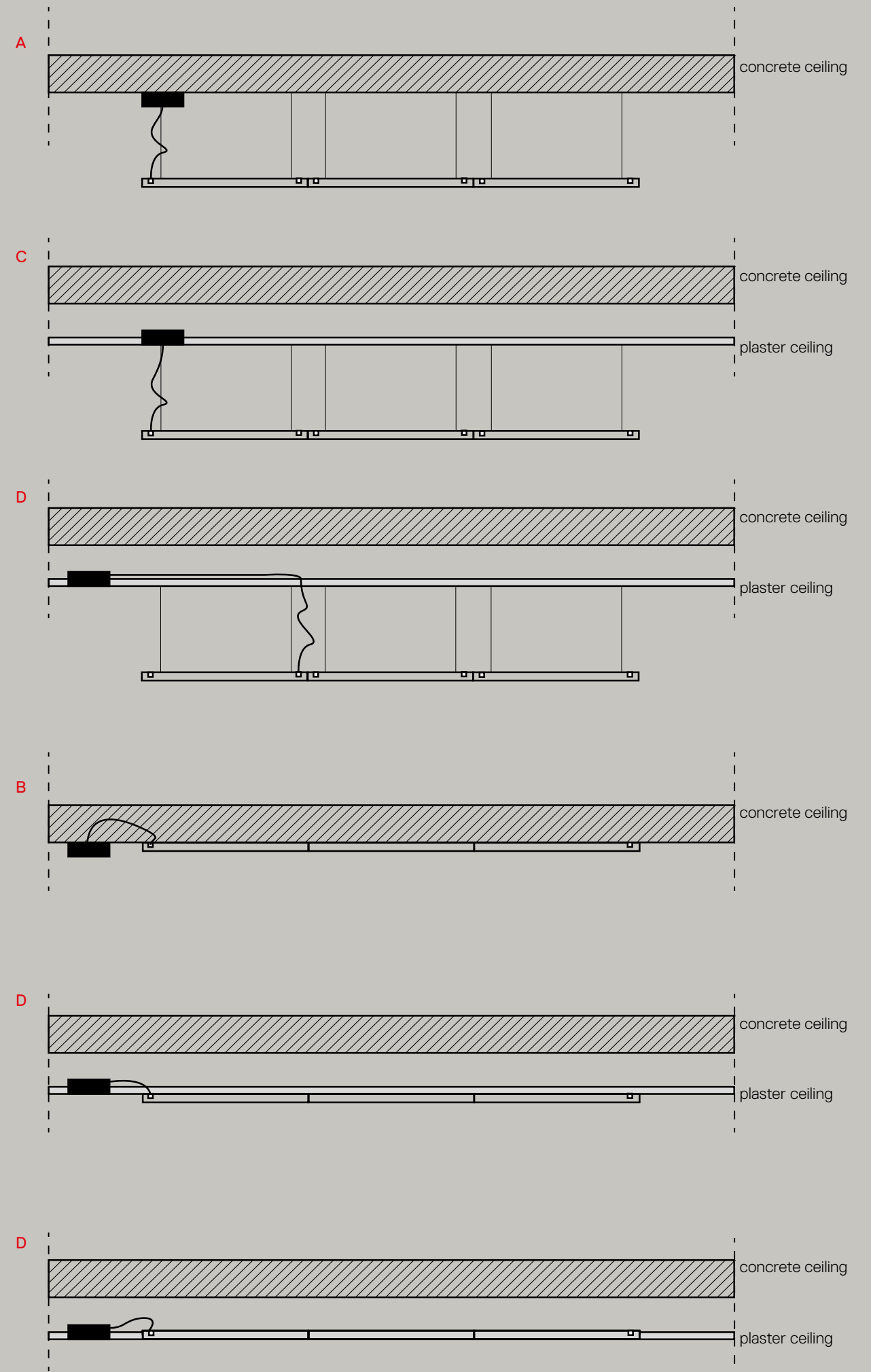



A.24  
↪ System

## ↪ A.24 RECESSED MAGNETIC TRACK

White Black



IP20



### Linear elements

#### Length

1176mm  
2352 mm

#### Code

**AQ150.** 01/04  
**AQ151.** 01/04

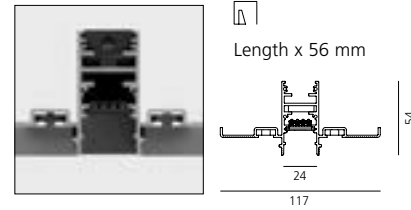

### Angle elements

90° on same plane track angle elements  
301 x 301 mm

#### Code

**AQ155.** 01/04

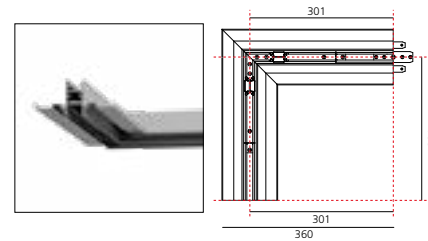

90° on perpendicular planes track angle elements  
276x276mm

#### Code

**AQ156.** 01/04

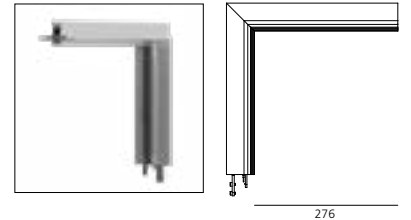

### Curved joining elements (not magnetic)

Radius Alpha  
561 mm 60°

#### Code

**AQ500.** 01/04

90°

**AQ510.** 01/04

750 mm 45°

**AQ520.** 01/04

90°

**AQ530.** 01/04

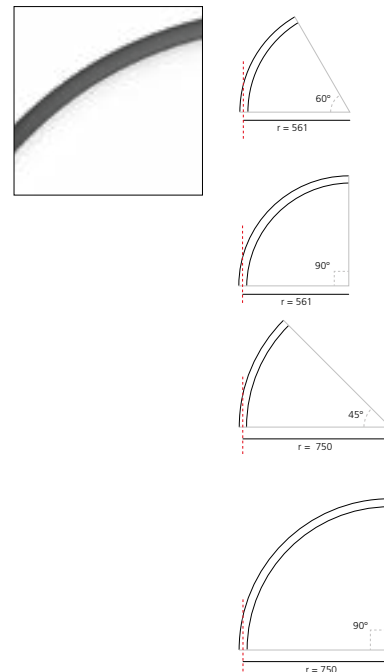

### Formwork (aluminum)

Length	Radius	Alpha
Curved	561 mm	60°
		90°
	750 mm	45°
		90°

#### Code

**AQ59000**

**AQ59100**

**AQ59200**

**AQ59300**

End caps (2pcs)

**AQ29400**

Each linear, angle and curved element is provided with mechanical and electrical joints and installation accessories.  
End caps have to be ordered separately.  
The APP driver can not be controlled by DALI dimming system and viceversa.  
For the effective powers of the drivers, see the table on page. 331

### Accessories



**Insulating spacer**  
(1 pcs) use between modules powered by different power supplies

#### Code

**AQ152.** 01/04



**End caps**  
(2 pcs)

**AQ153.** 01/04



**Transition joint**  
use between different typology modules (track-diffusing-sharping)

**AQ290.** 01/04

### Power supply



**240W Recessed power supply kit** (cable length 2,2 m) for recessed modules  
230VAC-48VDC  
**IP20** Ⓢ  
396x195x112H

### Undimmable

#### Code

**AQ17801**



**240W Ceiling power supply kit** (cable length 2,2 m) for recessed modules  
230VAC-48VDC  
**IP20** Ⓢ  
351x61x111H

**AQ173.** 01/04



**150W Ceiling power supply kit** (cable length 2,2 m) for recessed modules  
230VAC-48VDC  
**IP20** Ⓢ  
351x61x111H

**AQ179.** 01/04



**240W Bare power supply + plug ON-OFF** 230VAC-48VDC  
**IP20** Ⓢ  
(for dimmable version to be combined with "DALI-Selv interface") **244x68x38H**

**AQ18000**



**150W Bare power supply + plug ON-OFF** 230VAC-48VDC  
**IP20** Ⓢ  
(for dimmable version to be combined with "DALI-Selv interface") **244x68x38H**

**AQ18100**



**240W Recessed power supply kit** (cable length 2,2 m) for recessed modules  
230VAC-48VDC  
**IP20** Ⓢ  
396x195x112H

### Dimmable DALI /APP

#### Code

**AQ16801**

**AQ16801APP**



**240W Ceiling power supply kit** (cable length 2,2 m) for recessed modules  
230VAC-48VDC  
**IP20** Ⓢ  
321x91x111H

**AQ172.** 01/04

**AQ172.** 01/04 **APP**



**150W Ceiling power supply kit** (cable length 2,2 m) for recessed modules  
230VAC-48VDC  
**IP20** Ⓢ  
321x91x111H

**AQ177.** 01/04

**AQ177.** 01/04 **APP**

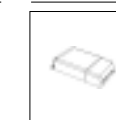

**DALI to DALI-Selv Interface**  
103x67x21H

**AQ18200**

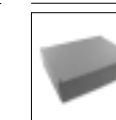

**240W Remote box power supply kit** (2 connectors)  
230VAC-48VDC  
**IP20** Ⓢ  
313x243x57,5H

**AQ16000**

**AQ16000APP**

## ↪ A.24 SUSPENSION MAGNETIC TRACK

White	Black	Brushed Silver	Brushed Copper	Brushed Bronze	WF	*Uses 1 DALI address	IP20
01	04	15	18	20			
Fast delivery		Delivery time on demand					

Each linear, angle and curved elements are provided with mechanical and electrical joints, and installation accessories.  
1 suspension cable is also included.  
End caps have to be ordered separately.  
The APP driver can not be controlled by DALI dimming system and viceversa.  
For the effective powers of the drivers, see the table on page. 331

Linear elements		Code
Length		
1176 mm		<b>AQ400.</b> 01/04 15/18/20
2352 mm		<b>AQ401.</b> 01/04 15/18/20

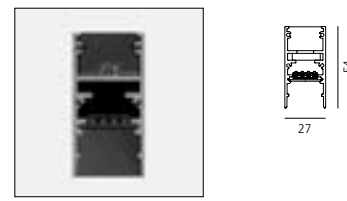

Linear + indirect emission elements					Code
Length	W	CRI	Flux	CCT	
1176 mm*	16W	80	1524 lm	2700K	<b>AQ406.</b> 01/04 15/18/20
				3000K	<b>AQ402.</b> 01/04 15/18/20
				4000K	<b>AQ403.</b> 01/04 15/18/20
2352 mm	33W	80	3049 lm	2700K	<b>AQ407.</b> 01/04 15/18/20
				3000K	<b>AQ404.</b> 01/04 15/18/20
				4000K	<b>AQ405.</b> 01/04 15/18/20

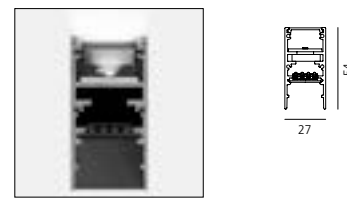

90° angle elements		Code
90° suspended track corner (on same plane)		
301x301mm		<b>AQ492.</b> 01/04 15/18/20

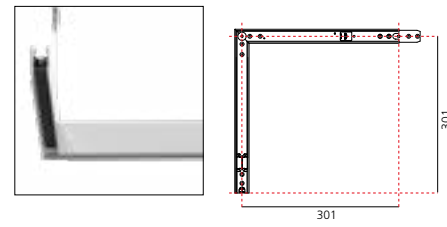

Curved joining elements (not magnetic)		Code
Radius	Alpha	
561 mm	60°	<b>AQ700.</b> 01/04 15/18/20
	90°	<b>AQ710.</b> 01/04 15/18/20
	90°	<b>AQ730.</b> 01/04 15/18/20
750 mm	45°	<b>AQ720.</b> 01/04 15/18/20
	90°	<b>AQ730.</b> 01/04 15/18/20
	90°	<b>AQ730.</b> 01/04 15/18/20

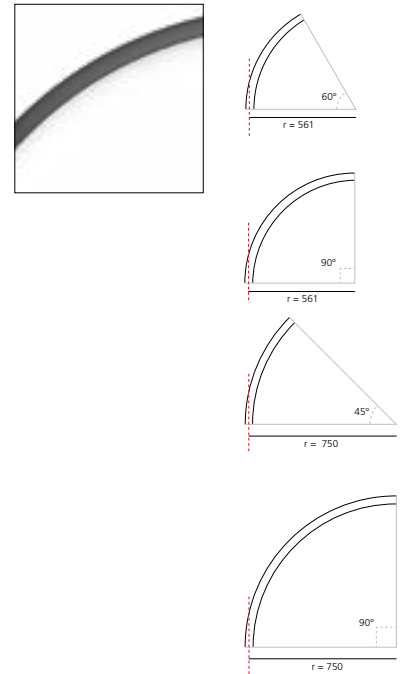

Accessories		Code
	Insulating spacer (1 pcs) between modules powered by different power supplies	<b>AQ491.</b> 01/04 15/18/20
	End cap (2 pcs) including 2 suspension cables 200H	<b>AQ490.</b> 01/04 15/18/20
	Transition joint between different typology modules (track-diffusing- sharping)	<b>AQ494.</b> 01/04 15/18/20

Power supply		Undimmable	Dimmable DALI / APP
	240W Recessed power supply kit (cable length 2,2 m)  230VAC-48VDC IP20 396x195x112H	<b>AQ174.</b> 01/04	<b>AQ154.</b> 01/04 <b>AQ154.</b> 01/04 APP
	240W Ceiling power supply kit (cable length 2,2 m)  230VAC-48VDC IP20 351x61x111H	<b>AQ171.</b> 01/04	<b>AQ161.</b> 01/04 <b>AQ161.</b> 01/04 APP
	150W Ceiling power supply kit (cable length 2,2 m)  230VAC-48VDC IP20 351x61x111H	<b>AQ176.</b> 01/04	<b>AQ175.</b> 01/04 <b>AQ175.</b> 01/04 APP
	240W Bare power supply + plug <b>ON-OFF</b> 230VAC-48VDC IP20 (for dimmable version to be combined with "DALI-Selv interface") <b>244x68x38H</b>	<b>AQ18000</b>	<b>AQ18200</b>
	150W Bare power supply + plug <b>ON-OFF</b> 230VAC-48VDC IP20 (for dimmable version to be combined with "DALI-Selv interface") <b>244x68x38H</b>	<b>AQ18100</b>	<b>AQ16000</b> <b>AQ16000APP</b>

	240W (eff. 210W) Recessed power supply kit (cable length 2,2 m) 230VAC-48VDC IP20 396x195x112H		
	240W Ceiling power supply kit (cable length 2,2 m) 230VAC-48VDC IP20 351x61x111H		
	321x91x111H 150W Ceiling power supply kit (cable length 2,2 m) 230VAC-48VDC IP20 103x67x21H		
	240W Remote box power supply kit (2 connectors) 230VAC-48VDC IP20 313x243x57,5H		

## ↪ A.24 CEILING MAGNETIC TRACK

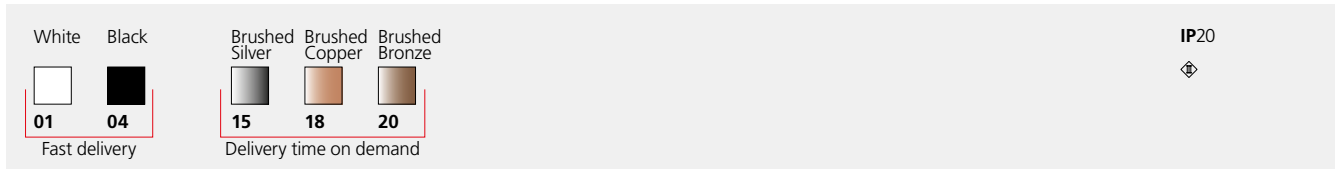

### Linear elements

Length	Code
1176 mm	<b>AQ300.</b> 01/04 15/18/20
2352 mm	<b>AQ301.</b> 01/04 15/18/20

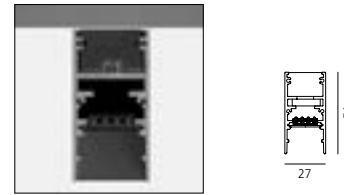

### 90° angle elements

90° on same plane track angle elements	Code
301 x 301 mm	<b>AQ392.</b> 01/04 15/18/20

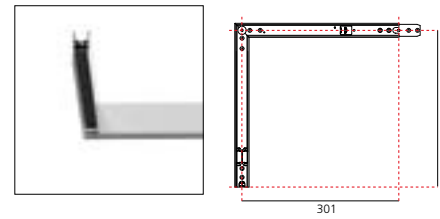

90° on perpendicular planes track angle elements	Code
330 x 330 mm	<b>AQ393.</b> 01/04 15/18/20

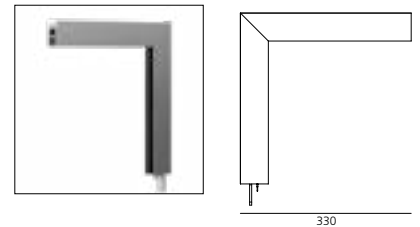

### Curved joining elements (not magnetic)

Radius	Alpha	Code
561 mm	60°	<b>AQ600.</b> 01/04 15/18/20
	90°	<b>AQ610.</b> 01/04 15/18/20
750 mm	45°	<b>AQ620.</b> 01/04 15/18/20
	90°	<b>AQ630.</b> 01/04 15/18/20

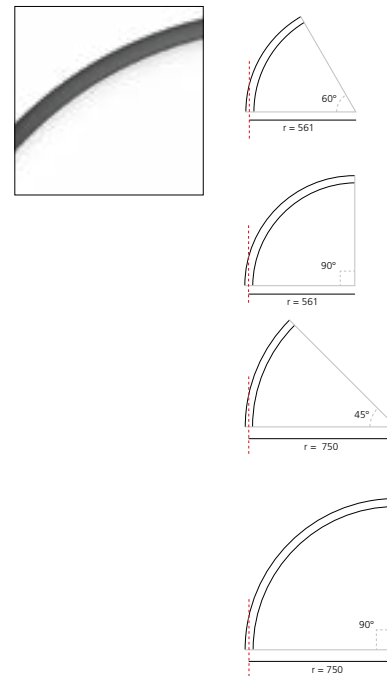

Each linear, angle and curved elements are provided with mechanical and electrical joints, and installation accessories.  
Bracket for fixing to ceiling is included: 1 for 1176 mm length or 2 for 2352 mm length.  
End caps have to be ordered separately.  
The APP driver can not be controlled by DALI dimming system and viceversa.  
For the effective powers of the drivers, see the table on page. 331

### Accessories

	Code
Insulating spacer (1 pcs) use between modules powered by different power supplies	<b>AQ391.</b> 01/04 15/18/20
End caps (2 pcs)	<b>AQ390.</b> 01/04 15/18/20
Cap for cable passage (1 pcs)	<b>AQ395.</b> 01/04 15/18/20
Transition joint use between different typology modules (track-diffusing-sharping)	<b>AQ394.</b> 01/04 15/18/20

### Power supply

	Undimmable Code	Dimmable DALI / APP Code
240W Recessed power supply kit (cable length 2,2 m) 230VAC-48VDC IP20 396x195x112H	<b>AQ17801</b>	<b>AQ16801</b> <b>AQ16801APP</b>
240W Ceiling power supply kit (cable length 2,2 m) 230VAC-48VDC 240W IP20 351x61x111H	<b>AQ173.</b> 01/04	<b>AQ172.</b> 01/04 <b>AQ172.</b> 01/04 <b>APP</b>
150W Ceiling power supply kit (cable length 2,2 m) 230VAC-48VDC 240W IP20 351x61x111H	<b>AQ179.</b> 01/04	<b>AQ177.</b> 01/04 <b>AQ177.</b> 01/04 <b>APP</b>
240W Bare power supply + plug <b>ON-OFF</b> 230VAC-48VDC IP20 (for dimmable version to be combined with "DALI-Selv interface") <b>244x68x38H</b>	<b>AQ18000</b>	<b>AQ18200</b>
150W Bare power supply + plug <b>ON-OFF</b> 230VAC-48VDC IP20 (for dimmable version to be combined with "DALI-Selv interface") <b>244x68x38H</b>	<b>AQ18100</b>	<b>AQ16000</b> <b>AQ16000APP</b>
240W Remote box power supply kit (2 connectors) 230VAC-48VDC IP20 313x243x57,5H		

## ↳ VECTOR MAGNETIC TRACK

White Black  
 01 04  
 Fast delivery

Brushed Silver Brushed Copper Brushed Bronze  
 15 18 20  
 Delivery time on demand

S F WF

Delivery time on demand  
 2700K / 4000K

MacAdam 3SDCM  
 CRI = 80

IP20  
 90°  
 360°

### VECTOR 20 MAGNETIC

W	Beam	Flux	CCT	Dimmable DALI Code
2 W	S 10°	175 lm	2700K	AP711. 01/04 15/18/20
			3000K	AP701. 01/04 15/18/20
			4000K	AP751. 01/04 15/18/20
	F 24°	160 lm	2700K	AP712. 01/04 15/18/20
			3000K	AP702. 01/04 15/18/20
			4000K	AP752. 01/04 15/18/20
WF 32°	140 lm	2700K	AP713. 01/04 15/18/20	
		3000K	AP703. 01/04 15/18/20	
		4000K	AP753. 01/04 15/18/20	



Life L90 (6K) >36300h

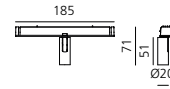

### VECTOR 30 MAGNETIC

W	Beam	Flux	CCT	Dimmable DALI Code
6 W	XS 6°	475 lm	2700K	AP811. 01/04 15/18/20
			3000K	AP801. 01/04 15/18/20
			4000K	AP851. 01/04 15/18/20
	F 24°	450 lm	2700K	AP812. 01/04 15/18/20
			3000K	AP802. 01/04 15/18/20
			4000K	AP852. 01/04 15/18/20
WF 40°	425 lm	2700K	AP813. 01/04 15/18/20	
		3000K	AP803. 01/04 15/18/20	
		4000K	AP853. 01/04 15/18/20	



Life L90 (10K) >60500h

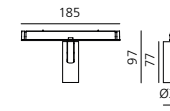

## VECTOR MAGNETIC TRACK

White Black  
 01 04  
 Fast delivery

Brushed Silver Brushed Copper Brushed Bronze  
 15 18 20  
 Delivery time on demand

S F WF

Delivery time on demand  
 2700K / 4000K

MacAdam 3SDCM  
 \*MacAdam 2SDCM  
 CRI = 90

IP20  
 90°  
 360°

### VECTOR 40 MAGNETIC

W	Beam	Flux	CCT	Dimmable DALI Code
10 W	S 13°	540 lm	2700K	AP011. 01/04 15/18/20
			3000K	AP001. 01/04 15/18/20
			4000K	AP051. 01/04 15/18/20
	*F 20°	584 lm	2700K	AP012. 01/04 15/18/20
			3000K	AP002. 01/04 15/18/20
			4000K	AP052. 01/04 15/18/20
*WF 28°	528 lm	2700K	AP013. 01/04 15/18/20	
		3000K	AP003. 01/04 15/18/20	
		4000K	AP053. 01/04 15/18/20	



Life L90 (10K) 60500h

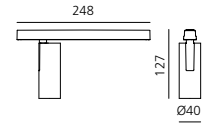

### VECTOR 55 MAGNETIC

W	Beam	Flux	CCT	Dimmable DALI Code
26 W	S 16°	1492 lm	2700K	AP111. 01/04 15/18/20
			3000K	AP101. 01/04 15/18/20
			4000K	AP151. 01/04 15/18/20
	F 22°	1465 lm	2700K	AP112. 01/04 15/18/20
			3000K	AP102. 01/04 15/18/20
			4000K	AP152. 01/04 15/18/20
WF 32°	1596 lm	2700K	AP113. 01/04 15/18/20	
		3000K	AP103. 01/04 15/18/20	
		4000K	AP153. 01/04 15/18/20	



Life L80 (9K) >50000h

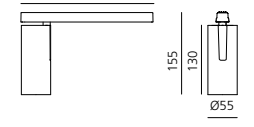

Accessoires	Color	Vector 40 Code	Vector 55 Code
Accessories holder		AP90100	AP91100
Lens for elliptical emission		AP90200	AP91200
Soft filter		AP90300	AP91300
Anti-dazzle louvre		AP90400	AP91400
Adjustable dowsers	●		AP91500

## ↳ VECTOR MAGNETIC TRACK

White	Black	Brushed Silver	Brushed Copper	Brushed Bronze	S	F	WF	Delivery time on demand 2700K / 4000K	MacAdam 3SDCM CRI = 90	IP20 90° 360°
01	04	15	18	20						
Fast delivery		Delivery time on demand								

### VECTOR 55 ZOOM MAGNETIC

W	Beam	Flux	CCT	Dimmable DALI Code
23 W	F 22°-WF 32°	660 - 1137 lm	2700K	<b>AP114.</b> 01/04 15/18/20
			3000K	<b>AP104.</b> 01/04 15/18/20
			4000K	<b>AP154.</b> 01/04 15/18/20

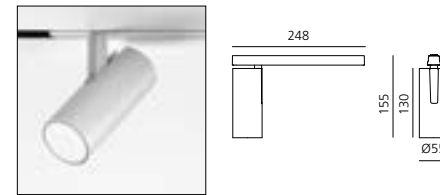

Life L80 (9K)>50000h

### VECTOR 40 PENDANT MAGNETIC

W	Beam	Flux	CCT	Dimmable DALI Code
10 W	S 13°	540 lm	2700K	<b>AP211.</b> 01/04 15/18/20
			3000K	<b>AP201.</b> 01/04 15/18/20
			4000K	<b>AP251.</b> 01/04 15/18/20
	F 20°	584 lm	2700K	<b>AP212.</b> 01/04 15/18/20
			3000K	<b>AP202.</b> 01/04 15/18/20
			4000K	<b>AP252.</b> 01/04 15/18/20
WF 28°	528 lm	2700K	<b>AP213.</b> 01/04 15/18/20	
		3000K	<b>AP203.</b> 01/04 15/18/20	
		4000K	<b>AP253.</b> 01/04 15/18/20	

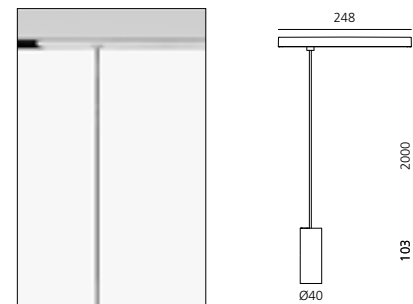

Life L90 (10K) 60500h

### VECTOR 55 PENDANT MAGNETIC

W	Beam	Flux	CCT	Dimmable DALI Code
26 W	S 16°	1492 lm	2700K	<b>AP311.</b> 01/04 15/18/20
			3000K	<b>AP301.</b> 01/04 15/18/20
			4000K	<b>AP351.</b> 01/04 15/18/20
	F 22°	1465 lm	2700K	<b>AP312.</b> 01/04 15/18/20
			3000K	<b>AP302.</b> 01/04 15/18/20
			4000K	<b>AP352.</b> 01/04 15/18/20
WF 32°	1596 lm	2700K	<b>AP313.</b> 01/04 15/18/20	
		3000K	<b>AP303.</b> 01/04 15/18/20	
		4000K	<b>AP353.</b> 01/04 15/18/20	

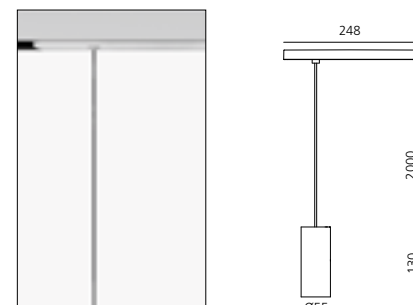

Life L80 (9K)>50000h



## ↪ A.24 RECESSED DIFFUSED EMISSION

White  <b>01</b>	WF 	*Uses 1 DALI address ** Uses 2 DALI addresses	MacAdam 2SDCM Life L80 (10K)>55000h CRI = 80	IP20 
---	---	--	--	---

Each formwork module is provided with a mechanical joint to connect two recessed coplanar formwork modules. Each module, angle and curved elements are provided with mechanical and electrical joints and installation accessories. End caps have to be ordered separately. Opal diffusing screen has to be ordered separately. The APP driver can not be controlled by DALI dimming system and viceversa. For the effective powers of the drivers, see the table on page. 331

Formwork (aluminum)			
Length	Radius	Alpha	Code
Linear 1176mm			<b>AQ29100</b>
Linear 2352 mm			<b>AQ29200</b>
90° angle on the same plane			<b>AQ29300</b>
90° angle on perpendicular			<b>AQ29500</b>
Curved	561 mm	60°	<b>AQ59000</b>
	750 mm	90°	<b>AQ59100</b>
		45°	<b>AQ59200</b>
		90°	<b>AQ59300</b>
End caps (2pcs)			<b>AQ29400</b>

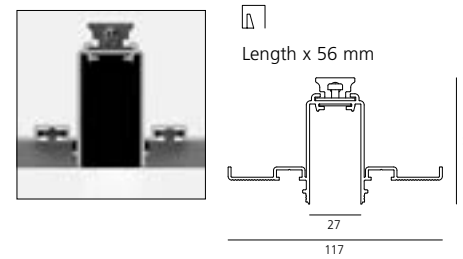

Linear direct emission elements			
Length	W	Flux	CCT
1176mm*	33W	2841 lm	2700K
		2884 lm	3000K
		3013 lm	4000K
2352 mm**	66W	5682 lm	2700K
		5769 lm	3000K
		6027 lm	4000K



90° angle direct emission elements			
	W	Flux	CCT
90° on same plane angle direct emission elements	16W	1420 lm	2700K
		1442 lm	3000K
		1506 lm	4000K

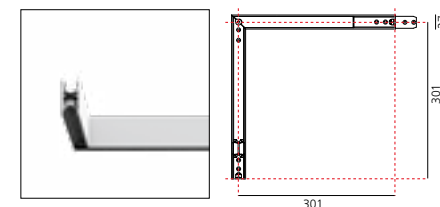



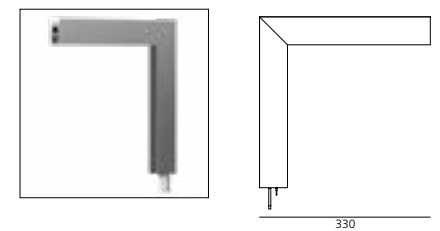



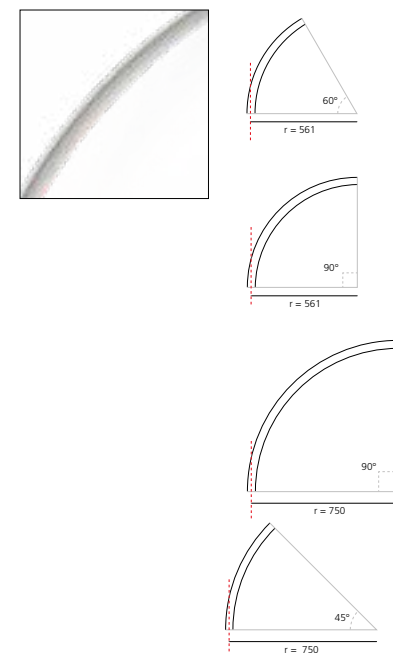

	W	Flux	CCT
90° on perpendicular plane angle direct emission elements	16W	1362 lm	2700K
		1383 lm	3000K
		1444 lm	4000K



Curved direct emission elements				
Radius	Alpha	W	Flux	CCT
561 mm*	60°	17W	1187 lm	2700K
				3000K
				4000K
90°	25W	1781 lm	2700K	
			3000K	
			4000K	
750 mm*	45°	17W	1187 lm	2700K
				3000K
				4000K
90°	34W	2374 lm	2700K	
			3000K	
			4000K	



Accessories		Code
	Insulating spacer (1 pcs) between modules powered by different power supplies	<b>AQ20601</b>
	End caps (2 pcs)	<b>AQ25001</b>
	Transition joint use between different typology modules (track-diffusing-sharping)	<b>AQ29001</b>
	Opal diffusing screen	
	10m	<b>AQ16200</b>
	25m	<b>AQ16300</b>
	50m	<b>AQ16400</b>
	1176 mm	<b>AQ16500</b>
	2352 mm	<b>AQ16600</b>
	3528 mm	<b>AQ16700</b>
	Flexible opal diffusing screen	
	5m	<b>AQ90300</b>
	10m	<b>AQ90000</b>
	25m	<b>AQ90100</b>
	50m	<b>AQ90200</b>

Power supply		Undimmable	Dimmable DALI / APP
	240W Recessed power supply kit (cable length 2,2 m) 230VAC-48VDC IP20 Ⓢ 396x195x112H	<b>AQ17801</b>	<b>AQ16801</b> <b>AQ16801APP</b>
	240W Ceiling power supply kit (cable length 2,2 m) 230VAC-48VDC IP20 Ⓢ 351x61x111H	<b>AQ17301</b>	<b>AQ172. 01/04</b> <b>AQ172. 01/04 APP</b>
	150W Ceiling power supply kit (cable length 2,2 m) 230VAC-48VDC IP20 Ⓢ 351x61x111H	<b>AQ17901</b>	<b>AQ177. 01/04</b> <b>AQ177. 01/04 APP</b>
	240W Bare power supply + plug <b>ON-OFF</b> 230VAC-48VDC IP20 Ⓢ (for dimmable version to be combined with "DALI-Selv interface") <b>244x68x38H</b>	<b>AQ18000</b>	<b>AQ18200</b>
	150W Bare power supply + plug <b>ON-OFF</b> 230VAC-48VDC IP20 Ⓢ (for dimmable version to be combined with "DALI-Selv interface") <b>244x68x38H</b>	<b>AQ18100</b>	<b>AQ16000</b> <b>AQ16000APP</b>

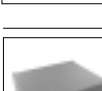
	240W Recessed power supply kit (cable length 2,2 m) 230VAC-48VDC IP20 Ⓢ 396x195x112H	<b>AQ16801</b> <b>AQ16801APP</b>
	240W Ceiling power supply kit (cable length 2,2 m) 230VAC-48VDC IP20 Ⓢ 321x91x111H	<b>AQ172. 01/04</b> <b>AQ172. 01/04 APP</b>
	150W Ceiling power supply kit (cable length 2,2 m) 230VAC-48VDC IP20 Ⓢ 321x91x111H	<b>AQ177. 01/04</b> <b>AQ177. 01/04 APP</b>
	DALI to DALI-Selv Interface 103x67x21H	<b>AQ18200</b>
	240W Remote box power supply kit (2 connectors) 230VAC-48VDC IP20 Ⓢ <b>313x243x57,5H</b>	<b>AQ16000</b> <b>AQ16000APP</b>



## ↪ A.24 SUSPENSION DIFFUSED EMISSION

White	Black	Brushed Silver	Brushed Copper	Brushed Bronze	WF	*Uses 1 DALI address	MacAdam 2SDCM	IP20
01	04	15	18	20		** Uses 2 DALI addresses	Life L80 (10K)>55000h	
Fast delivery		Delivery time on demand				*** Uses 3 DALI addresses	CRI = 80	

Each module, angle and curved elements are provided with mechanical and electrical joints and installation accessories.  
1 suspension cable is also included.  
End caps have to be ordered separately.  
Opal diffusing screen has to be ordered separately.  
The APP driver can not be controlled by DALI dimming system and viceversa.  
For the effective powers of the drivers, see the table on page. 331

### Linear direct emission elements

Length	W	Flux	CCT
1176 mm*	33W	2841 lm	2700K
		2884 lm	3000K
		3013 lm	4000K
2352 mm**	66W	5682 lm	2700K
		5769 lm	3000K
		6027 lm	4000K

Code
AQ416. 01/04 15/18/20
AQ410. 01/04 15/18/20
AQ411. 01/04 15/18/20
AQ417. 01/04 15/18/20
AQ412. 01/04 15/18/20
AQ413. 01/04 15/18/20

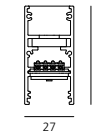

### Linear direct and indirect emission elements

Length	W	Flux	CCT
1176 mm**	33W direct	2841 lm direct	2700K
		16W indirect	1502 lm indirect
	1524 lm indirect	2884 lm direct	3000K
		3013 lm direct	4000K
		1593 lm indirect	
2352 mm***	66W direct	5682 lm direct	2700K
		32W indirect	3004 lm indirect
	3049 lm indirect	5769 lm direct	3000K
		6027 lm direct	4000K
		3185 lm indirect	

Code
AQ464. 01/04 15/18/20
AQ460. 01/04 15/18/20
AQ461. 01/04 15/18/20
AQ465. 01/04 15/18/20
AQ462. 01/04 15/18/20
AQ463. 01/04 15/18/20

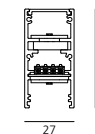
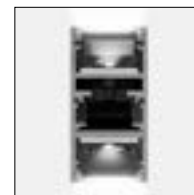

### 90° angle direct emission elements

	W	Flux	CCT
90° on same plane angle elements	16W	1420 lm	2700K
301 x 301 mm*		1442 lm	3000K
		1506 lm	4000K

Code
AQ418. 01/04 15/18/20
AQ414. 01/04 15/18/20
AQ415. 01/04 15/18/20

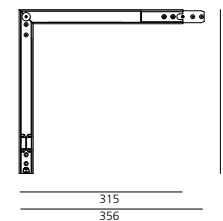

### Curved direct emission elements

Radius	Alpha	W	Flux	CCT	
561 mm*	60°	17W	1187 lm	2700K	
				3000K	
				4000K	
90°	25W	1781 lm	2700K		
				3000K	
				4000K	
750 mm*	45°	17W	1187 lm	2700K	
				3000K	
				4000K	
	90°	34W	2374 lm	2700K	
					3000K
					4000K

Code
AQ707. 01/04 15/18/20
AQ701. 01/04 15/18/20
AQ702. 01/04 15/18/20
AQ717. 01/04 15/18/20
AQ711. 01/04 15/18/20
AQ712. 01/04 15/18/20
AQ727. 01/04 15/18/20
AQ721. 01/04 15/18/20
AQ722. 01/04 15/18/20
AQ737. 01/04 15/18/20
AQ731. 01/04 15/18/20
AQ732. 01/04 15/18/20

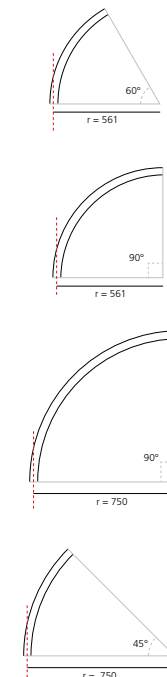

### Accessories

	Code
Insulating spacer (1 pcs) between modules powered by different power supplies	AQ452. 01/04 15/18/20
End caps (2 pcs) including 2 suspension cables 200H	AQ451. 01/04 15/18/20
Transition joint use between different typology modules (track-diffusing-sharpping)	AQ494. 01/04 15/18/20
Opal diffusing screen 10m 25m 50m 1176 mm 2352 mm 3528 mm Flexible opal diffusing screen 5m 10m 25m 50m	AQ16200 AQ16300 AQ16400 AQ16500 AQ16600 AQ16700 AQ90300 AQ90000 AQ90100 AQ90200

### Power supply

	Code
240W Recessed power supply kit (cable length 2,2 m) 230VAC-48VDC IP20 396x195x112H	AQ174. 01/04
240W Ceiling power supply kit (cable length 2,2 m) 230VAC-48VDC IP20 351x61x111H	AQ171. 01/04
150W Ceiling power supply kit (cable length 2,2 m) 230VAC-48VDC IP20 351x61x111H	AQ176. 01/04
240W Bare power supply + plug ON-OFF 230VAC-48VDC IP20 (for dimmable version to be combined with "DALI-Selv interface") 244x68x38H	AQ18000
150W Bare power supply + plug ON-OFF 230VAC-48VDC IP20 (for dimmable version to be combined with "DALI-Selv interface") 244x68x38H	AQ18100

	Code
240W Recessed power supply kit (cable length 2,2 m) 230VAC-48VDC IP20 396x195x112H	AQ154. 01/04 AQ154. 01/04 APP
240W Ceiling power supply kit (cable length 2,2 m) 230VAC-48VDC IP20 321x91x111H	AQ161. 01/04 AQ161. 01/04 APP
150W Ceiling power supply kit (cable length 2,2 m) 230VAC-48VDC IP20 321x91x111H	AQ175. 01/04 AQ175. 01/04 APP
DALI to DALI-Selv Interface 103x67x21H	AQ18200
240W Remote box power supply kit (2 connectors) 230VAC-48VDC IP20 313x243x57,5H	AQ16000 AQ16000APP

## ↪ A.24 CEILING - WALL DIFFUSED EMISSION

White	Black	Brushed Silver	Brushed Copper	Brushed Bronze	WF	*Uses 1 DALI address ** Uses 2 DALI addresses	MacAdam 2SDCM Life L80 (10K)>55000h CRI = 80	IP20
01	04	15	18	20				
Fast delivery		Delivery time on demand						

Each linear, angle and curved elements are provided with mechanical and electrical joints, and installation accessories.  
Bracket for fixing to ceiling is included: 1 for 1176 mm lenght. 2 for 2352 mm lenght.  
End caps have to be ordered separately.  
Opal diffusing screen has to be ordered separately.  
The APP driver can not be controlled by DALI dimming system and viceversa.  
For the effective powers of the drivers, see the table on page. 331

### Linear direct emission elements

Length	W	Flux	CCT
1176 mm*	33W	2841 lm	2700K
		2884 lm	3000K
		3013 lm	4000K
2352 mm**	66W	5682 lm	2700K
		5769 lm	3000K
		6027 lm	4000K

Code
AQ370. 01/04 15/18/20
AQ310. 01/04 15/18/20
AQ311. 01/04 15/18/20
AQ371. 01/04 15/18/20
AQ312. 01/04 15/18/20
AQ313. 01/04 15/18/20



### 90° angle direct emission elements

	W	Flux	CCT
90° on same plane angle elements	16W	1420 lm	2700K
301 x 301 mm*		1442 lm	3000K
		1506 lm	4000K

Code
AQ372. 01/04 15/18/20
AQ314. 01/04 15/18/20
AQ315. 01/04 15/18/20

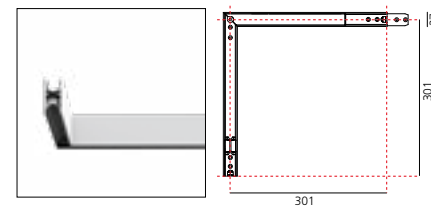

	W	Flux	CCT
90° on perpendicular planes angle elements	16W	1362 lm	2700K
330 x 330 mm*		1383 lm	3000K
		1444 lm	4000K

Code
AQ373. 01/04 15/18/20
AQ316. 01/04 15/18/20
AQ317. 01/04 15/18/20

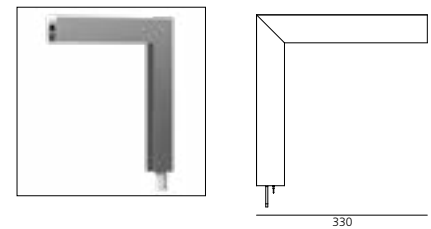

### Curved direct emission elements

Radius	Alpha	W	Flux	CCT
561 mm*	60°	17W	1187 lm	2700K
				3000K
				4000K
90°	25W	1781 lm	2700K	
				3000K
				4000K
750 mm*	45°	17W	1187 lm	2700K
				3000K
				4000K
90°	34W	2374 lm	2700K	
				3000K
				4000K

Code
AQ607. 01/04 15/18/20
AQ601. 01/04 15/18/20
AQ602. 01/04 15/18/20
AQ617. 01/04 15/18/20
AQ611. 01/04 15/18/20
AQ612. 01/04 15/18/20
AQ627. 01/04 15/18/20
AQ621. 01/04 15/18/20
AQ622. 01/04 15/18/20
AQ637. 01/04 15/18/20
AQ631. 01/04 15/18/20
AQ632. 01/04 15/18/20

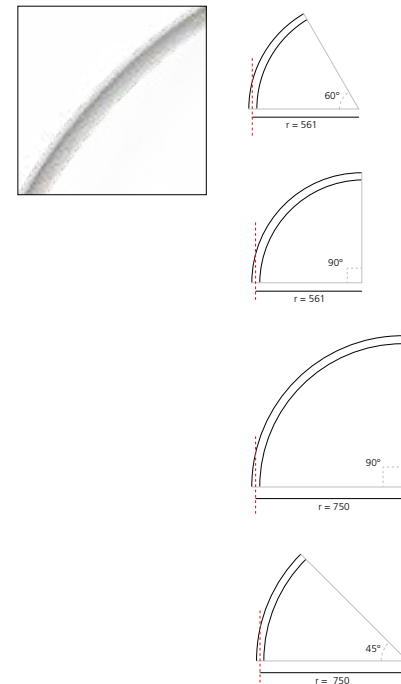

### Accessories

	Code
Insulating spacer (1 pc) between modules powered by different power supplies	AQ351. 01/04 15/18/20
End cap (2 pcs)	AQ350. 01/04 15/18/20
Cap for cable passage (1 pcs)	AQ353. 01/04 15/18/20
Transition cap track - diffusing track - sharpening diffusing - sharpening	AQ394. 01/04 15/18/20

	Code
Opal diffusing screen	AQ16200
10m	AQ16300
25m	AQ16400
50m	AQ16500
1176 mm	AQ16600
2352 mm	AQ16700
3528 mm	
Flexible opal diffusing screen	
5m	AQ90300
10m	AQ90000
25m	AQ90100
50m	AQ90200

### Power supply

	Code
240W Recessed power supply kit (cable length 2,2 m) 230VAC-48VDC IP20 396x195x112H	AQ17801
240W Ceiling power supply kit (cable length 2,2 m) 230VAC-48VDC 240W IP20 351x61x111H	AQ173. 01/04
150W Ceiling power supply kit (cable length 2,2 m) 230VAC-48VDC 240W IP20 351x61x111H	AQ179. 01/04
240W Bare power supply + plug ON-OFF 230VAC-48VDC IP20 (for dimmable version to be combined with "DALI-Selv interface")	AQ18000
150W Bare power supply + plug ON-OFF 230VAC-48VDC IP20 (for dimmable version to be combined with "DALI-Selv interface")	AQ18100

	Code
240W Recessed power supply kit (cable length 2,2 m) 230VAC-48VDC IP20 396x195x112H	AQ16801 AQ16801APP
240W Ceiling power supply kit (cable length 2,2 m) 230VAC-48VDC IP20 321x91x111H	AQ172. 01/04 AQ172. 01/04 APP
150W Ceiling power supply kit (cable length 2,2 m) 230VAC-48VDC IP20 321x91x111H	AQ177. 01/04 AQ177. 01/04 APP
DALI to DALI-Selv Interface 103x67x21H	AQ18200
240W Remote box power supply kit (2 connectors) 230VAC-48VDC IP20 313x243x57,5H	AQ16000 AQ16000APP

A.24 MODULE

Structural module

Mechanical and electrical connections

Optics

SHARPING KIT

End Cover

Louvre

Intermediate Cover

## ↪ A.24 RECESSED SHARPING EMISSION

White Black F XF \*Uses 1 DALI address MacAdam 2SDCM IP20  
 \*\* Uses 2 DALI addresses Life L90 (20K) 118000h  
 CRI = 90

Formwork (aluminum)			Code
Length	Radius	Alpha	
Linear 1176mm			<b>AQ29100</b>
Linear 2352 mm			<b>AQ29200</b>
90° angle on the same plane			<b>AQ29300</b>
Curved	561 mm	60°	<b>AQ59000</b>
		90°	<b>AQ59100</b>
	750 mm	45°	<b>AQ59200</b>
		90°	<b>AQ59300</b>
End caps (2pcs)			<b>AQ29400</b>

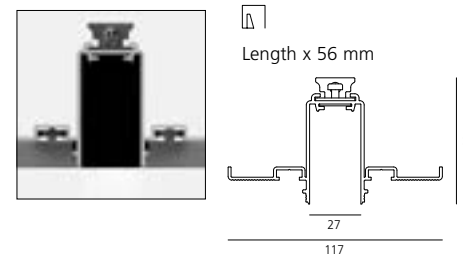

Linear direct emission elements					Code
Length	W	Beam	Flux	CCT	
1176mm*	22W	F 24°	1528 lm	2700K	<b>AQ214. 01/04</b>
			1628 lm	3000K	<b>AQ210. 01/04</b>
			1742 lm	4000K	<b>AQ211. 01/04</b>
		XF 62°	1624 lm	2700K	<b>AQ234. 01/04</b>
			1731 lm	3000K	<b>AQ230. 01/04</b>
			1852 lm	4000K	<b>AQ231. 01/04</b>
2352 mm**	46W	F 24°	3056 lm	2700K	<b>AQ215. 01/04</b>
			3256 lm	3000K	<b>AQ212. 01/04</b>
			3485 lm	4000K	<b>AQ213. 01/04</b>
		XF62°	3249 lm	2700K	<b>AQ235. 01/04</b>
			3461 lm	3000K	<b>AQ232. 01/04</b>
			3704 lm	4000K	<b>AQ233. 01/04</b>



90° angle joining elements (not lit)		Code
90° recessed corner (on same plane)		<b>AQ240. 01/04</b>
301x301mm		

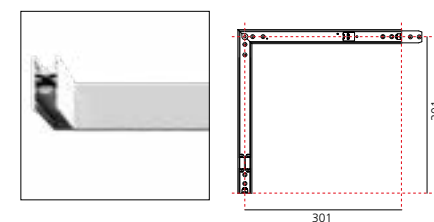

Curved direct emission elements						Code	
Radius	Alpha	W	Beam	Flux	CCT		
561 mm*	60°	12W	F 24°	839 lm	2700K	<b>AQ508. 01/04</b>	
						3000K	<b>AQ503. 01/04</b>
						4000K	<b>AQ505. 01/04</b>
			XF 62°	777 lm	2700K	<b>AQ509. 01/04</b>	
						3000K	<b>AQ504. 01/04</b>
						4000K	<b>AQ506. 01/04</b>
90°	12W	F 24°	839 lm	2700K	<b>AQ518. 01/04</b>		
					3000K	<b>AQ513. 01/04</b>	
					4000K	<b>AQ515. 01/04</b>	
		XF 62°	777 lm	2700K	<b>AQ519. 01/04</b>		
					3000K	<b>AQ514. 01/04</b>	
					4000K	<b>AQ516. 01/04</b>	
750 mm*	45°	12W	F 24°	839 lm	2700K	<b>AQ528. 01/04</b>	
						3000K	<b>AQ523. 01/04</b>
						4000K	<b>AQ525. 01/04</b>
			XF 62°	777 lm	2700K	<b>AQ529. 01/04</b>	
						3000K	<b>AQ524. 01/04</b>
						4000K	<b>AQ526. 01/04</b>
90°	25W	F 24°	1678 lm	2700K	<b>AQ538. 01/04</b>		
					3000K	<b>AQ533. 01/04</b>	
					4000K	<b>AQ535. 01/04</b>	
		XF 62°	1555 lm	2700K	<b>AQ539. 01/04</b>		
					3000K	<b>AQ534. 01/04</b>	
					4000K	<b>AQ536. 01/04</b>	

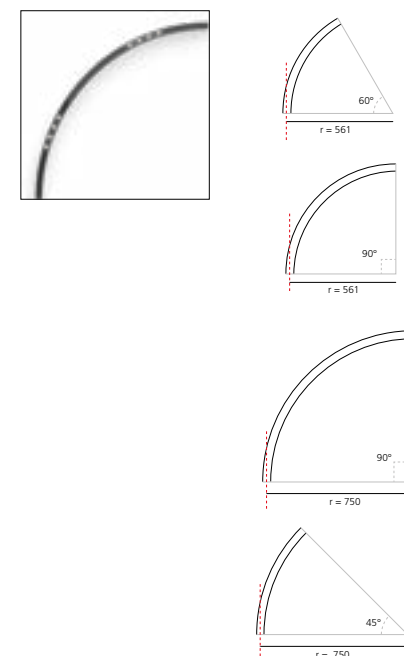

Each formwork module is provided with a mechanical joint to connect two recessed coplanar formwork modules. Each module, angle and curved elements are provided with mechanical and electrical joints and installation accessories. End caps have to be ordered separately. Sharping kit (louvers and covers) has to be ordered separately. The APP driver can not be controlled by DALI dimming system and viceversa. For the effective powers of the drivers, see the table on page. 331

Accessories		Code		Code
	Insulating spacer (1 pc) between modules powered by different power supplies	<b>AQ241. 01/04</b>		<b>Louvers for linear elements Sharping kit L=1176mm</b> (2 louvers - 1 intermediate cover - 2 end covers) <b>AQ260. 01/04</b> <b>Louvers for linear elements Sharping kit L=2352mm</b> (4 louvers - 3 intermediate cover - 2 end covers) <b>AQ261. 01/04</b> <b>90° angle cover</b> (2 pcs) <b>AQ262. 01/04</b>
	End caps (2 pcs)	<b>AQ250. 01/04</b>		<b>Louvers for curved elements R=561mm/R=750mm</b> <b>AQ911. 01/04</b> R=561mm 60° order 1 pc 90° order 1 pc R=750mm 45° order 1 pc 90° order 2 pcs <b>Flexible cover 2m</b> <b>AQ921. 01/04</b> <b>Flexible cover 10m</b> <b>AQ920. 01/04</b>
	Transition joint use between different typology modules (track-diffusing-sharping)	<b>AQ290. 01/04</b>		

Power supply		Undimmable	Dimmable DALI / APP
	240W Recessed power supply kit (cable length 2,2 m) 230VAC-48VDC IP20 396x195x112H	<b>AQ17801</b>	<b>AQ16801</b> <b>AQ16801APP</b>
	240W Ceiling power supply kit (cable length 2,2 m) 230VAC-48VDC IP20 351x61x111H	<b>AQ173. 01/04</b>	<b>AQ172. 01/04</b> <b>AQ172. 01/04 APP</b>
	150W Ceiling power supply kit (cable length 2,2 m) 230VAC-48VDC IP20 351x61x111H	<b>AQ179. 01/04</b>	<b>AQ177. 01/04</b> <b>AQ177. 01/04 APP</b>
	240W Bare power supply + plug ON-OFF 230VAC-48VDC IP20 (for dimmable version to be combined with "DALI-Selv interface") <b>244x68x38H</b>	<b>AQ18000</b>	<b>AQ18200</b>
	150W Bare power supply + plug ON-OFF 230VAC-48VDC IP20 (for dimmable version to be combined with "DALI-Selv interface") <b>244x68x38H</b>	<b>AQ18100</b>	<b>AQ16000</b> <b>AQ16000APP</b>

## ↪ A.24 SUSPENSION SHARPING EMISSION

White Black Brushed Silver Brushed Copper Brushed Bronze F XF

01 04 15 18 20

Fast delivery Delivery time on demand

\*Uses 1 DALI address MacAdam 2SDCM IP20  
 \*\* Uses 2 DALI addresses Life L90 (20K) 118000h  
 \*\*\* Uses 3 DALI addresses CRI = 90

Each linear, angle and curved elements are provided with mechanical and electrical joints, and installation accessories. 1 suspension cable is also included. End caps have to be ordered separately. Sharping kit (louvers and covers) has to be ordered separately.

Linear direct emission elements					Code
Length	W	Beam	Flux	CCT	
1176 mm*	22W	F 24°	1528 lm	2700K	<b>AQ424.</b> 01/04
			1628 lm	3000K	<b>AQ420.</b> 01/04
			1742 lm	4000K	<b>AQ421.</b> 01/04
		XF 62°	1624 lm	2700K	<b>AQ444.</b> 01/04
			1731 lm	3000K	<b>AQ440.</b> 01/04
			1852 lm	4000K	<b>AQ441.</b> 01/04
			3056 lm	2700K	<b>AQ425.</b> 01/04
			3256 lm	3000K	<b>AQ422.</b> 01/04
			3485 lm	4000K	<b>AQ423.</b> 01/04
2352 mm**	46W	F 24°	3249 lm	2700K	<b>AQ445.</b> 01/04
			3461 lm	3000K	<b>AQ442.</b> 01/04
			3704 lm	4000K	<b>AQ443.</b> 01/04
		XF 62°	3249 lm	2700K	<b>AQ445.</b> 01/04
			3461 lm	3000K	<b>AQ442.</b> 01/04
			3704 lm	4000K	<b>AQ443.</b> 01/04

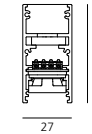

Linear direct and indirect emission elements					Code		
Length	W	Beam	Flux	CCT			
1176 mm**	22W direct 16W indirect	F 24°	1528 lm direct	2700K	<b>AQ482.</b> 01/04		
			1406 lm indirect				
			1628 lm direct	3000K	<b>AQ470.</b> 01/04		
		XF 62°	1525 lm indirect				
			1742 lm direct	4000K	<b>AQ471.</b> 01/04		
			1587 lm indirect				
			1624 lm direct	2700K	<b>AQ486.</b> 01/04		
			1502 lm indirect				
			1731 lm direct	3000K	<b>AQ478.</b> 01/04		
		2352 mm***	46W indirect 32W indirect	F 24°	1524 lm indirect		
					1858 lm direct	4000K	<b>AQ479.</b> 01/04
					1587 lm indirect		
				XF 62°	3056 lm direct	2700K	<b>AQ483.</b> 01/04
					3004 lm indirect		
					3256 lm direct	3000K	<b>AQ472.</b> 01/04
2352 mm***	46W indirect 32W indirect	F 24°	3049 lm indirect				
			3485 lm direct	4000K	<b>AQ473.</b> 01/04		
			3185 lm indirect				
		XF 62°	3249 lm direct	2700K	<b>AQ487.</b> 01/04		
			3004 lm indirect				
			3461 lm direct	3000K	<b>AQ480.</b> 01/04		
			3049 lm indirect				
			3704 lm direct	4000K	<b>AQ481.</b> 01/04		
			3185 lm indirect				

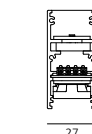

90° angle joining elements (not lit)		Code
90° suspension corner (on same plane)	301x301mm	<b>AQ450.</b> 01/04
		15/18/20

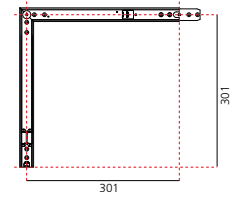
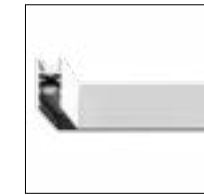



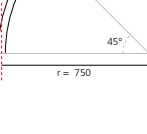
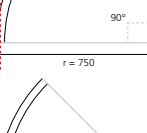
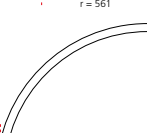
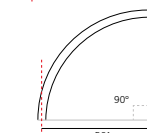
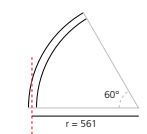







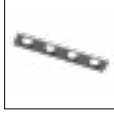



Curved direct emission elements						Code
Radius	Alpha	W	Beam	Flux	CCT	
561 mm*	60°	12W	F 24°	839 lm	2700K	<b>AQ708.</b> 01/04
					3000K	<b>AQ703.</b> 01/04
					4000K	<b>AQ705.</b> 01/04
			XF 62°	777 lm	2700K	<b>AQ709.</b> 01/04
				3000K	<b>AQ704.</b> 01/04	
				4000K	<b>AQ706.</b> 01/04	
	90°	12W	F 24°	839 lm	2700K	<b>AQ718.</b> 01/04
					3000K	<b>AQ713.</b> 01/04
					4000K	<b>AQ715.</b> 01/04
			XF 62°	777 lm	2700K	<b>AQ719.</b> 01/04
				3000K	<b>AQ714.</b> 01/04	
				4000K	<b>AQ716.</b> 01/04	
750 mm*	45°	12W	F 24°	839 lm	2700K	<b>AQ728.</b> 01/04
					3000K	<b>AQ723.</b> 01/04
					4000K	<b>AQ725.</b> 01/04
			XF 62°	777 lm	2700K	<b>AQ729.</b> 01/04
				3000K	<b>AQ724.</b> 01/04	
				4000K	<b>AQ726.</b> 01/04	
	90°	25W	F 24°	1678 lm	2700K	<b>AQ738.</b> 01/04
					3000K	<b>AQ733.</b> 01/04
					4000K	<b>AQ735.</b> 01/04
			XF 62°	1555 lm	2700K	<b>AQ739.</b> 01/04
				3000K	<b>AQ734.</b> 01/04	
				4000K	<b>AQ736.</b> 01/04	

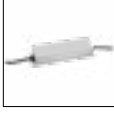

## ↪ A.24 SUSPENSION SHARPING EMISSION

Each linear, angle and curved elements are provided with mechanical and electrical joints, and installation accessories.  
 1 suspension cable is also included.  
 End caps have to be ordered separately.  
 Sharping kit (louvers and covers) has to be ordered separately.  
 The APP driver can not be controlled by DALI dimming system and viceversa.  
 For the effective powers of the drivers, see the table on page. 331

Accessories		Code			Code
	Insulating spacer (1 pcs) between modules powered by different power supplies	<b>AQ453.</b> 01/04 15/18/20		<b>Louvers for linear elements</b> Sharping kit L=1176mm (2 louvers - 1 intermediate cover - 2 end covers) Sharping kit L=2352mm (4 louvers - 3 intermediate cover - 2 end covers) 90° angle cover (2 pcs)	<b>AQ260.</b> 01/04  <b>AQ261.</b> 01/04  <b>AQ262.</b> 01/04
	End caps (2 pcs) including 2 suspension cables 200H	<b>AQ451.</b> 01/04 15/18/20		<b>Louvers for curved elements</b> R=561mm/R=750mm  R=561mm 60° order 1 pc 90° order 1 pc R=750mm 45° order 1 pc 90° order 2 pcs	<b>AQ911.</b> 01/04
	Transition cap track - diffusing track - sharpening diffusing - sharpening	<b>AQ494.</b> 01/04 15/18/20		Flexible cover 2m Flexible cover 10m	<b>AQ921.</b> 01/04 <b>AQ920.</b> 01/04
Power supply		Undimmable			Dimmable DALI / APP
	240W Recessed power supply kit (cable length 2,2 m) 230VAC-48VDC IP20 ☉ 396x195x112H	<b>AQ174.</b> 01/04		240W Recessed power supply kit (cable length 2,2 m) 230VAC-48VDC IP20 ☉ 396x195x112H	<b>AQ154.</b> 01/04 <b>AQ154.</b> 01/04 APP
	240W Ceiling power supply kit (cable length 2,2 m) 230VAC-48VDC IP20 ☉ 351x61x111H	<b>AQ171.</b> 01/04		240W Ceiling power supply kit (cable length 2,2 m) 230VAC-48VDC IP20 ☉ 321x91x111H	<b>AQ161.</b> 01/04 <b>AQ161.</b> 01/04 APP
	150W Ceiling power supply kit (cable length 2,2 m) 230VAC-48VDC IP20 ☉ 351x61x111H	<b>AQ176.</b> 01/04		150W Ceiling power supply kit (cable length 2,2 m) 230VAC-48VDC IP20 ☉ 321x91x111H	<b>AQ175.</b> 01/04 <b>AQ175.</b> 01/04 APP
	240W Bare power supply + plug <b>ON-OFF</b> 230VAC-48VDC IP20 ☉ (for dimmable version to be combined with "DALI-Selv interface") <b>244x68x38H</b>	<b>AQ18000</b>		DALI to DALI-Selv Interface 103x67x21H	<b>AQ18200</b>
	150W Bare power supply + plug <b>ON-OFF</b> 230VAC-48VDC IP20 ☉ (for dimmable version to be combined with "DALI-Selv interface") <b>244x68x38H</b>	<b>AQ18100</b>		240W Remote box power supply kit (2 connectors) 230VAC-48VDC IP20 ☉ <b>313x243x57,5H</b>	<b>AQ16000</b> <b>AQ16000APP</b>

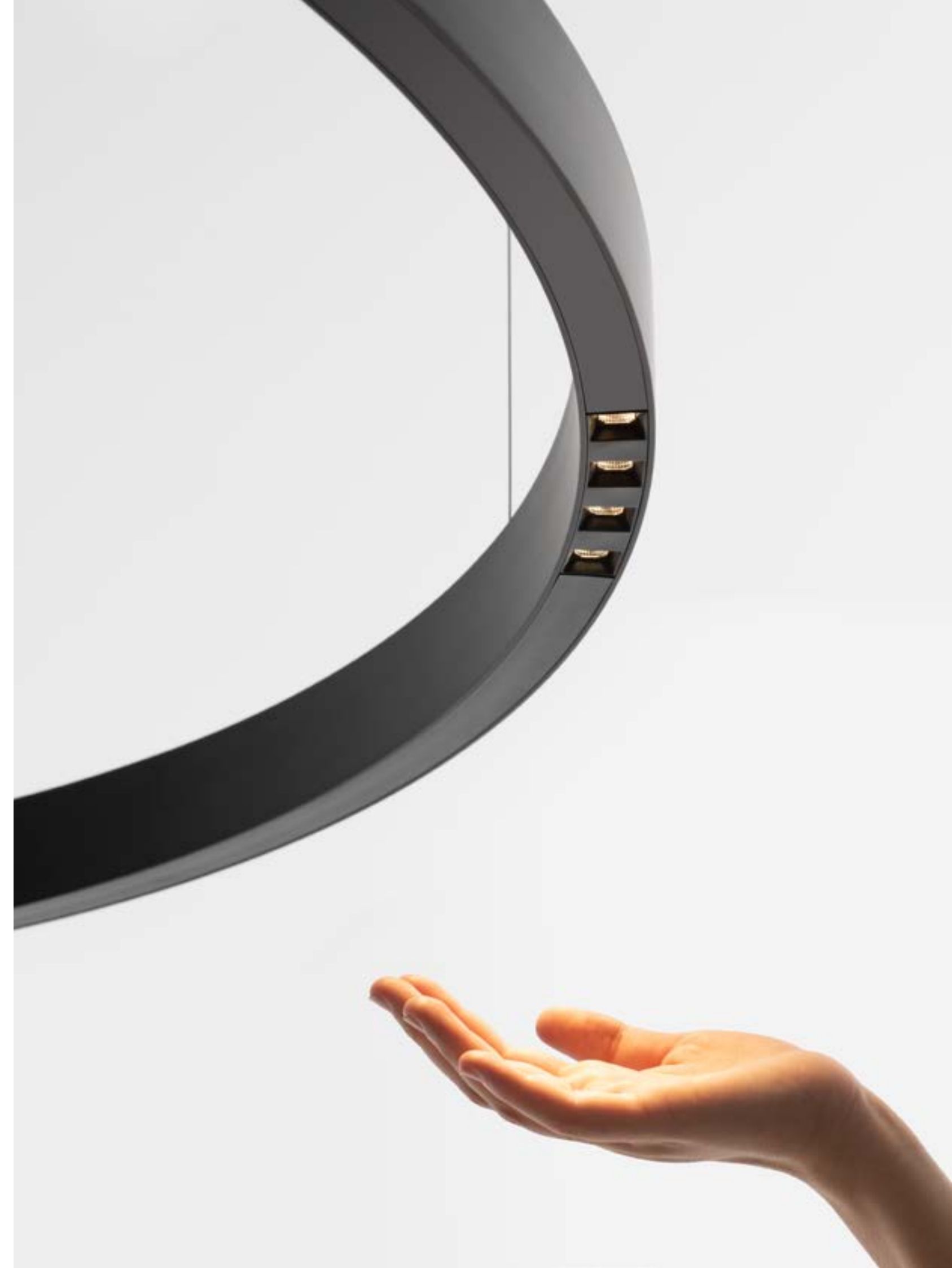

## ↪ A.24 CEILING SHARPING EMISSION

White Black  
 01 04  
 Fast delivery

Brushed Silver Brushed Copper Brushed Bronze  
 15 18 20  
 Delivery time on demand

F XF  
 \*Uses 1 DALI address  
 \*\* Uses 2 DALI addresses

MacAdam 2SDCM  
 Life L90 (20K) 118000h  
 CRI = 90

IP20

### Linear direct emission elements

Length	W	CRI	Beam	Flux	CCT	Code
1176 mm*	22W	90	F 24°	1528 lm	2700K	<b>AQ324.</b> 01/04 15/18/20
				1628 lm	3000K	<b>AQ320.</b> 01/04 15/18/20
				1742 lm	4000K	<b>AQ321.</b> 01/04 15/18/20
			XF 62°	1624 lm	2700K	<b>AQ344.</b> 01/04 15/18/20
				1731 lm	3000K	<b>AQ340.</b> 01/04 15/18/20
				1852 lm	4000K	<b>AQ341.</b> 01/04 15/18/20
				3056 lm	2700K	<b>AQ325.</b> 01/04 15/18/20
				3256 lm	3000K	<b>AQ322.</b> 01/04 15/18/20
				3485 lm	4000K	<b>AQ323.</b> 01/04 15/18/20
				3249 lm	2700K	<b>AQ345.</b> 01/04 15/18/20
XF 62°	3461 lm	3000K	<b>AQ342.</b> 01/04 15/18/20			
	3704 lm	4000K	<b>AQ343.</b> 01/04 15/18/20			



### 90° angle joining elements (not lit)

90° ceiling corner (on same plane)  
301x301mm

Code
<b>AQ360.</b> 01/04 15/18/20

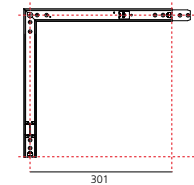
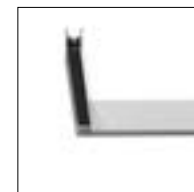

### Curved direct emission elements



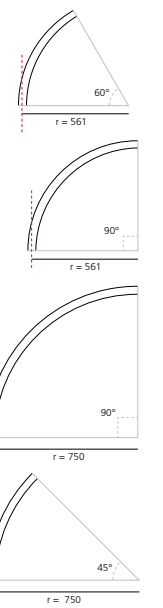
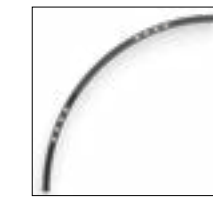



Radius	Alpha	W	CRI	Beam	Flux	CCT	Code
561 mm*	60°	12W	90	F 24°	839 lm	2700K	<b>AQ608.</b> 01/04 15/18/20
					3000K	<b>AQ603.</b> 01/04 15/18/20	
					4000K	<b>AQ605.</b> 01/04 15/18/20	
				XF 62°	777 lm	2700K	<b>AQ609.</b> 01/04 15/18/20
					3000K	<b>AQ604.</b> 01/04 15/18/20	
					4000K	<b>AQ606.</b> 01/04 15/18/20	
					839 lm	2700K	<b>AQ618.</b> 01/04 15/18/20
					3000K	<b>AQ613.</b> 01/04 15/18/20	
					4000K	<b>AQ615.</b> 01/04 15/18/20	
					777 lm	2700K	<b>AQ619.</b> 01/04 15/18/20
XF 62°	3000K	<b>AQ614.</b> 01/04 15/18/20					
	4000K	<b>AQ616.</b> 01/04 15/18/20					
	839 lm	2700K	<b>AQ628.</b> 01/04 15/18/20				
750 mm*	45°	12W	90	F 24°	839 lm	2700K	<b>AQ628.</b> 01/04 15/18/20
					3000K	<b>AQ623.</b> 01/04 15/18/20	
					4000K	<b>AQ625.</b> 01/04 15/18/20	
				XF 62°	777 lm	2700K	<b>AQ629.</b> 01/04 15/18/20
					3000K	<b>AQ624.</b> 01/04 15/18/20	
					4000K	<b>AQ626.</b> 01/04 15/18/20	
					1678 lm	2700K	<b>AQ638.</b> 01/04 15/18/20
					3000K	<b>AQ633.</b> 01/04 15/18/20	
					4000K	<b>AQ635.</b> 01/04 15/18/20	
					1555 lm	2700K	<b>AQ639.</b> 01/04 15/18/20
XF 62°	3000K	<b>AQ634.</b> 01/04 15/18/20					
	4000K	<b>AQ636.</b> 01/04 15/18/20					



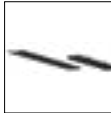

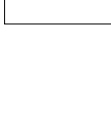

Each linear, angle and curved elements are provided with mechanical and electrical joints, and installation accessories.  
Bracket for fixing to ceiling is included: 1 for 1176 mm length - 2 for 2352 mm length.  
End caps have to be ordered separately.  
Sharpening kit (louvers and covers) has to be ordered separately.

## ↪ A.24 CEILING SHARPING EMISSION

Each linear, angle and curved elements are provided with mechanical and electrical joints, and installation accessories.  
Bracket for fixing to ceiling is included: 1 for 1176 mm length - 2 for 2352 mm length.  
End caps have to be ordered separately.  
Sharping kit (louvers and covers) has to be ordered separately.  
The APP driver can not be controlled by DALI dimming system and viceversa.  
For the effective powers of the drivers, see the table on page. 331

Accessories		Code	Accessories		Code
	Insulating spacer (1 pcs) between modules powered by differents power supply	AQ352. 01/04 15/18/20		<b>Louvers for linear elements</b> Sharping kit L=1176mm (2 louvers - 1 intermediate cover - 2 end covers)	AQ260. 01/04
	End caps (2 pcs)	AQ350. 01/04 15/18/20		<b>Sharping kit L=2352mm</b> (4 louvers - 3 intermediate cover - 2 end covers)	AQ261. 01/04
	Cap for cable passage (1 pcs)	AQ353. 01/04 15/18/20		90° angle cover (2 pcs)	AQ262. 01/04
	Transition cap track - diffusing track- sharpening diffusing - sharpening	AQ394. 01/04 15/18/20		<b>Louvers for curved elements</b> R=561mm/R=750mm	AQ911. 01/04
			R=561mm 60° order 1 pc 90° order 1 pc R=750mm 45° order 1 pc 90° order 2 pcs		
			Flexible cover 2m	AQ921. 01/04	
			Flexible cover 10m	AQ920. 01/04	

Power supply	Undimmable		Dimmable DALI / APP
	240W Recessed power supply kit (cable length 2,2 m) 230VAC-48VDC IP20 396x195x112H	AQ17801	240W Recessed power supply kit (cable length 2,2 m) 230VAC-48VDC IP20 396x195x112H
	240W Ceiling power supply kit (cable length 2,2 m) 230VAC-48VDC 240W IP20 351x61x111H	AQ173. 01/04	240W Ceiling power supply kit (cable length 2,2 m) 230VAC-48VDC IP20 321x91x111H
	150W Ceiling power supply kit (cable length 2,2 m) 230VAC-48VDC 240W IP20 351x61x111H	AQ179. 01/04	150W Ceiling power supply kit (cable length 2,2 m) 230VAC-48VDC IP20 321x91x111H
	240W Bare power supply + plug <b>ON-OFF</b> 230VAC-48VDC IP20 (for dimmable version to be combined with "DALI-Selv interface") <b>244x68x38H</b>	AQ18000	DALI to DALI-Selv Interface 103x67x21H
	150W Bare power supply + plug <b>ON-OFF</b> 230VAC-48VDC IP20 (for dimmable version to be combined with "DALI-Selv interface") <b>244x68x38H</b>	AQ18100	240W Remote box power supply kit (2 connectors) 230VAC-48VDC IP20 <b>313x243x57,5H</b>
			AQ16000 AQ16000APP







**A.24 circular**  
**↪ Stand-alone**



## ↪ A.24 STAND-ALONE CIRCULAR - DIFFUSED EMISSION

White 01 Fast delivery	Black 04	Brushed Silver 15 Delivery time on demand	Brushed Copper 18	Brushed Bronze 20	WF	220/240Vac 50/60Hz electronic ballast included	MacAdam 2SDCM Life L80 (10K)>55000h CRI = 80 Uses 1 DALI addresses.	IP20
------------------------------	-------------	---	----------------------	----------------------	----	--	--	------

### RECESSED

Direct emission				Dimmable DALI		APP	
Ø	W	Flux	CCT	Code	Code	Code	Code
1122 mm	102W	7124 lm	2700K	AQ54401	AQ54401APP	AQ54001	AQ54001APP
		7443 lm	3000K	AQ54101	AQ54101APP	AQ54101	AQ54101APP
		9499 lm	4000K	AQ55401	AQ55401APP	AQ55401	AQ55401APP
1500 mm	136W	7124 lm	2700K	AQ55001	AQ55001APP	AQ55001	AQ55001APP
		7443 lm	3000K	AQ55101	AQ55101APP	AQ55101	AQ55101APP
		9924 lm	4000K				

Formwork (aluminum) included

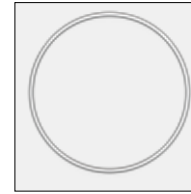

### SUSPENSION

Direct emission				Dimmable DALI		APP	
Ø	W	Flux	CCT	Code	Code	Code	Code
1122 mm	102W	7124 lm	2700K	AQ744. 01/04	AQ744. 01/04 APP	AQ744. 01/04	AQ744. 01/04 APP
		7443 lm	3000K	AQ740. 01/04	AQ740. 01/04 APP	AQ740. 01/04	AQ740. 01/04 APP
		9499 lm	4000K	AQ741. 01/04	AQ741. 01/04 APP	AQ741. 01/04	AQ741. 01/04 APP
1500 mm	136W	7124 lm	2700K	AQ754. 01/04	AQ754. 01/04 APP	AQ754. 01/04	AQ754. 01/04 APP
		7443 lm	3000K	AQ750. 01/04	AQ750. 01/04 APP	AQ750. 01/04	AQ750. 01/04 APP
		9924 lm	4000K	AQ751. 01/04	AQ751. 01/04 APP	AQ751. 01/04	AQ751. 01/04 APP

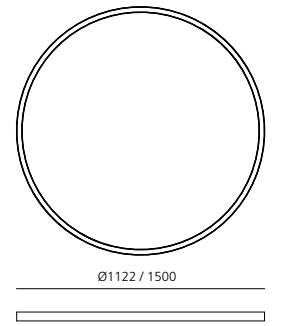

### CEILING

Direct emission				Dimmable DALI		APP	
Ø	W	Flux	CCT	Code	Code	Code	Code
1122 mm	102W	7124 lm	2700K	AQ644. 01/04	AQ644. 01/04 APP	AQ644. 01/04	AQ644. 01/04 APP
		7443 lm	3000K	AQ640. 01/04	AQ640. 01/04 APP	AQ640. 01/04	AQ640. 01/04 APP
		9499 lm	4000K	AQ641. 01/04	AQ641. 01/04 APP	AQ641. 01/04	AQ641. 01/04 APP
1550 mm	136W	7124 lm	2700K	AQ654. 01/04	AQ654. 01/04 APP	AQ654. 01/04	AQ654. 01/04 APP
		7443 lm	3000K	AQ650. 01/04	AQ650. 01/04 APP	AQ650. 01/04	AQ650. 01/04 APP
		9924 lm	4000K	AQ651. 01/04	AQ651. 01/04 APP	AQ651. 01/04	AQ651. 01/04 APP

### Accessories

Trimless frame to be used for recessing the power kit  
For suspension Stand-alone Ø 1122 and Ø 1500  
For ceiling Stand-alone Ø 1122 and Ø 1500

Code
AQ94000
AQ94200

## ↪ A.24 STAND-ALONE CIRCULAR - SHARPING EMISSION

White 01 Fast delivery	Black 04	Brushed Silver 15 Delivery time on demand	Brushed Copper 18	Brushed Bronze 20	F	220/240Vac 50/60Hz electronic ballast included	MacAdam 2SDCM Life L70 (6K) 50000h *Uses 1 DALI address ** Uses 2 DALI addresses	IP20
------------------------------	-------------	---	----------------------	----------------------	---	--	---	------

### RECESSED

Direct emission						Dimmable DALI		APP	
Ø	W	CRI	Beam	Flux	CCT	Code	Code	Code	Code
1122 mm*	50W	90	F 24°	3356 lm	2700K	AQ545. 01/04	AQ545. 01/04 APP	AQ542. 01/04	AQ542. 01/04 APP
				3576 lm	4000K	AQ543. 01/04	AQ543. 01/04 APP	AQ543. 01/04	AQ543. 01/04 APP
				6713 lm	2700K	AQ555. 01/04	AQ555. 01/04 APP	AQ552. 01/04	AQ552. 01/04 APP
1500 mm**	100W	90	F 24°	7152 lm	4000K	AQ553. 01/04	AQ553. 01/04 APP		

Formwork (aluminum) included

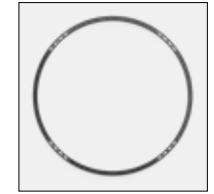

### SUSPENSION

Direct emission						Dimmable DALI		APP	
Ø	W	CRI	Beam	Flux	CCT	Code	Code	Code	Code
1122 mm*	50W	90	F 24°	3356 lm	2700K	AQ745. 01/04	AQ745. 01/04 APP	AQ742. 01/04	AQ742. 01/04 APP
				3576 lm	4000K	AQ743. 01/04	AQ743. 01/04 APP	AQ743. 01/04	AQ743. 01/04 APP
				6713 lm	2700K	AQ755. 01/04	AQ755. 01/04 APP	AQ752. 01/04	AQ752. 01/04 APP
1500 mm**	100W	90	F 24°	7152 lm	4000K	AQ753. 01/04	AQ753. 01/04 APP		

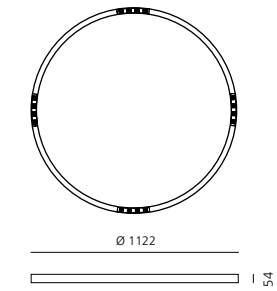

### CEILING

Direct emission						Dimmable DALI		APP	
Ø	W	CRI	Beam	Flux	CCT	Code	Code	Code	Code
1122 mm*	50W	90	F 24°	3356 lm	2700K	AQ645. 01/04	AQ645. 01/04 APP	AQ642. 01/04	AQ642. 01/04 APP
				3576 lm	4000K	AQ643. 01/04	AQ643. 01/04 APP	AQ643. 01/04	AQ643. 01/04 APP
				6713 lm	2700K	AQ655. 01/04	AQ655. 01/04 APP	AQ652. 01/04	AQ652. 01/04 APP
1500 mm**	100W	90	F 24°	7152 lm	4000K	AQ653. 01/04	AQ653. 01/04 APP		

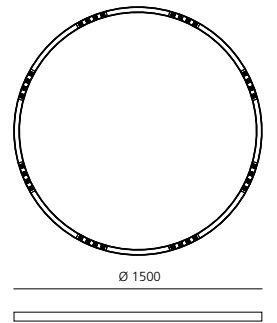

### Sharping accessories

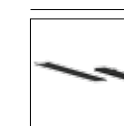

Sharping kit R=561mm  
(4 louvers - 4 covers)  
Sharping kit R=750mm  
(8 louvers - 8 covers)

Code
AQ930. 01/04
AQ931. 01/04

### Accessories

Trimless frame to be used for recessing the power kit  
For suspension Stand-alone Ø 1122 and Ø 1500  
For ceiling Stand-alone Ø 1122 and Ø 1500

Code
AQ94000
AQ94200

# A.39

Carlotta de Bevilacqua  
↪ 2017



Artemide  
App



For further information on A.39  
↪ visit [artemide.com](http://artemide.com)

# A.39 typologies

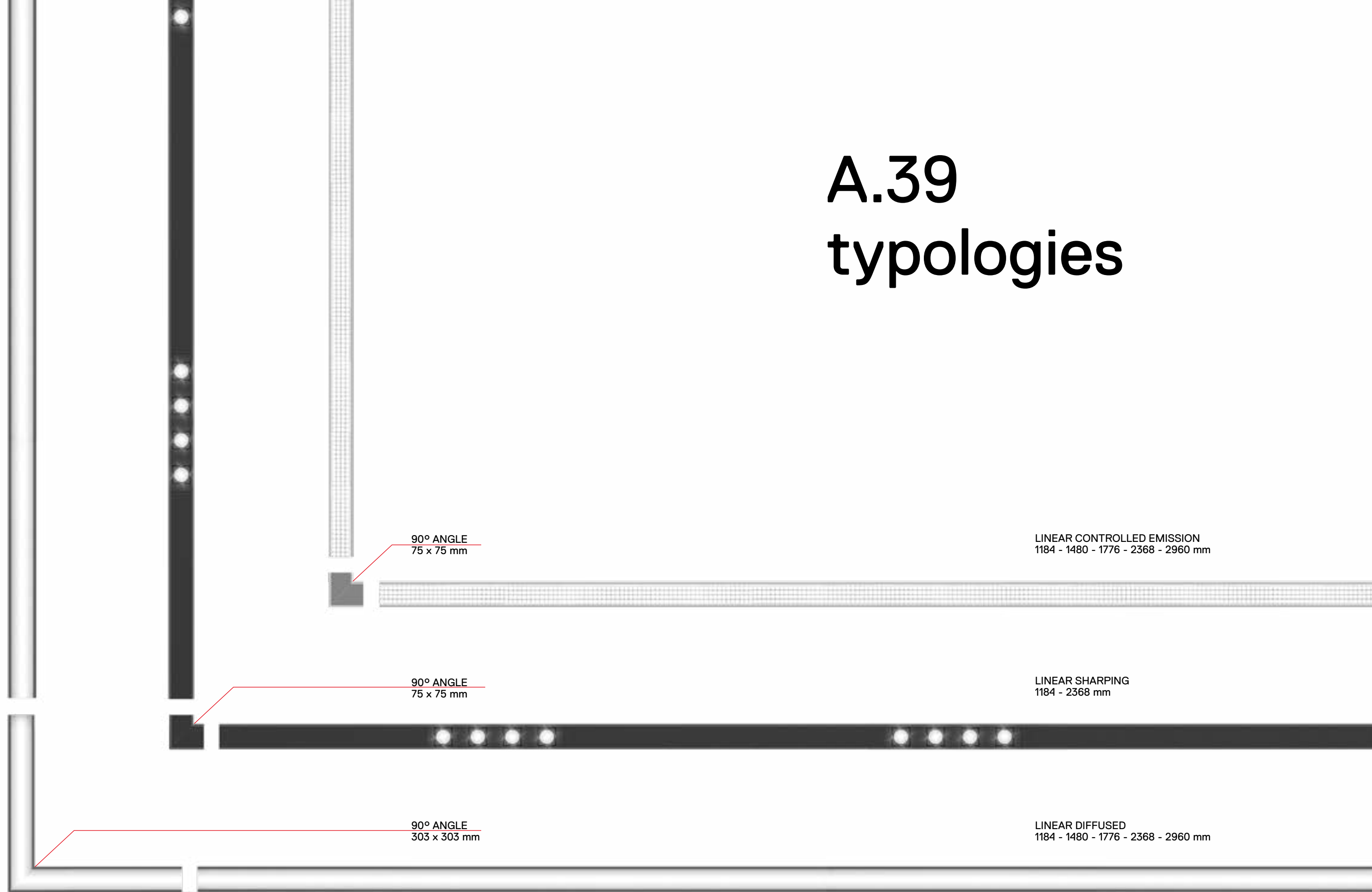

# A.39 colors

White



Silver



Black



# A.39 space fittings

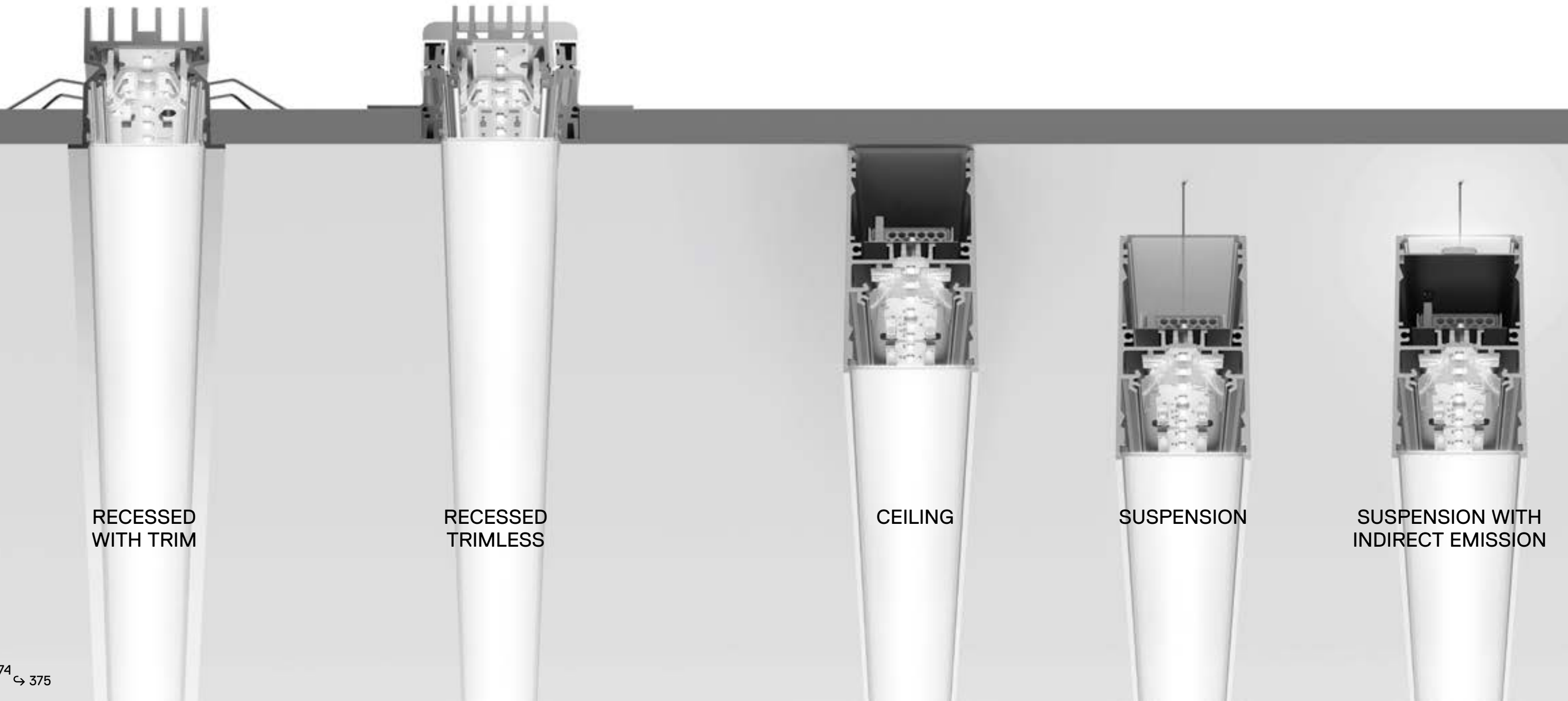

# A.39

## ↪ diffused

01. "All in one" construction.

02. a seamless and uniform brightness with no visible  
junctions thanks to a continuous roll diffuser.

03. continuous roll diffuser up to 50 m.

04. comfortable light emission.







→ TRIMLESS

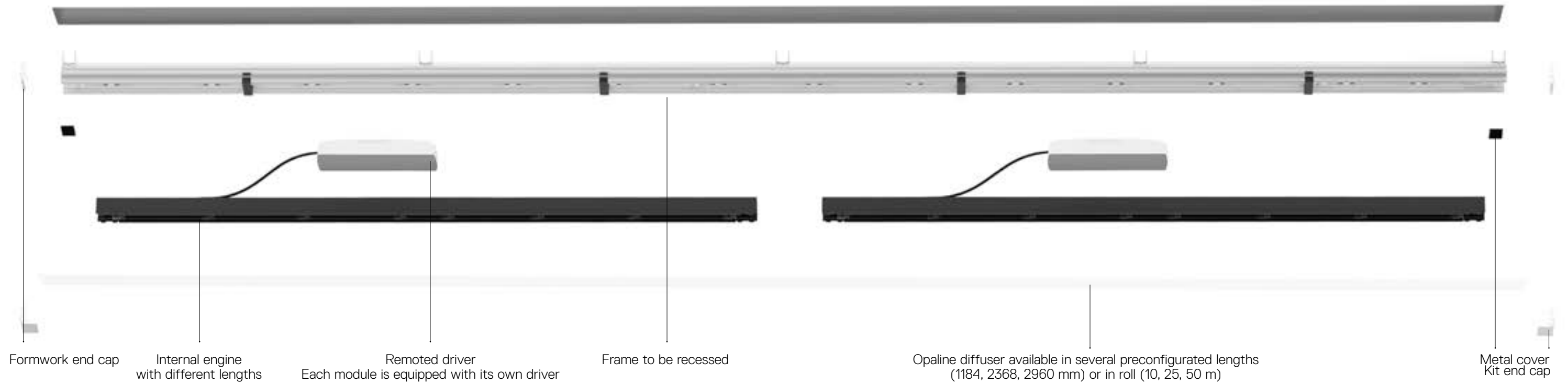

# A.39 diffused recessed components

→ TRIM

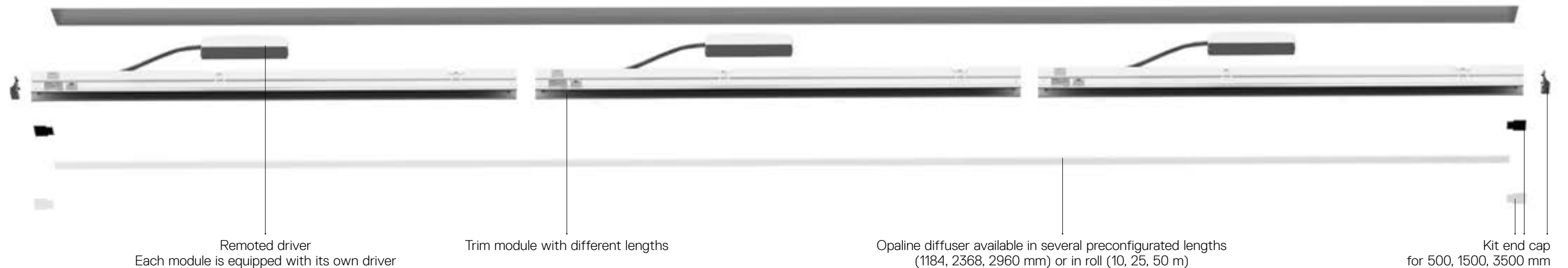

→ CEILING

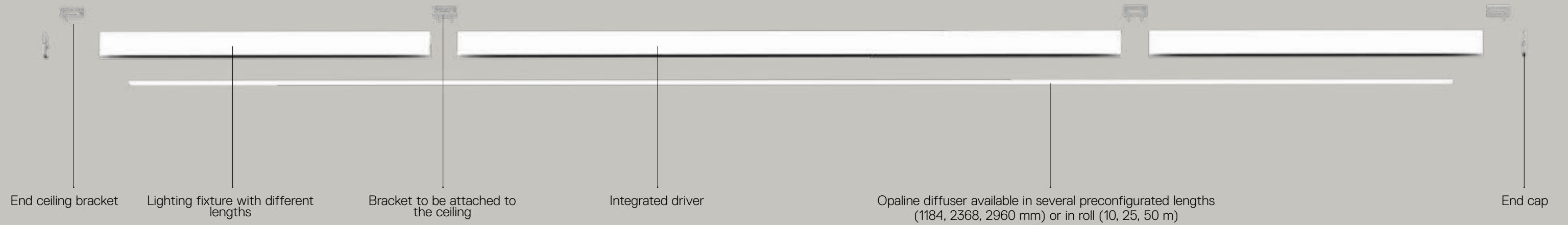

# A.39 diffused ceiling, suspension components

→ SUSPENSION

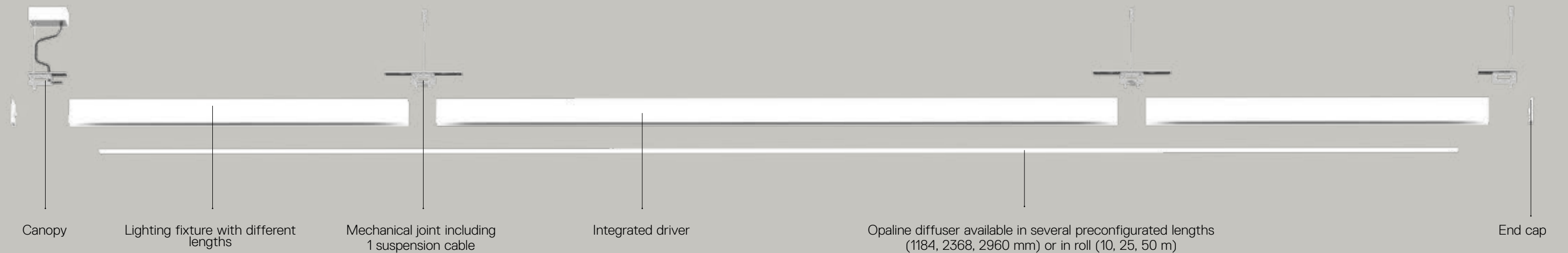

# A.39 diffused system modules

	1184 mm	1482 mm	1776 mm	2368 mm	2960 mm	2960 - 5000 mm	5000 - 15000 mm	15000 - 35000 mm	50000 mm	
END CAP KIT TRIM	5000 mm	○————○					○			
	15000 mm						○—○			
	50000 mm							○—○		
DIFFUSER	1184 mm	○—○								
	2368 mm		○————○							
	2960 mm					○—○				
ROLL DIFFUSER	10 m					○————○				
	25 m					○————○				
	50 m					○————○				
FORMWORK TRIMLESS	1480 mm	○————○								
	4736 mm		○————○							
END CAP KIT TRIMLESS	50000 mm	○————○								
	SPECIAL								○—○	

TRIM - TRIMLESS

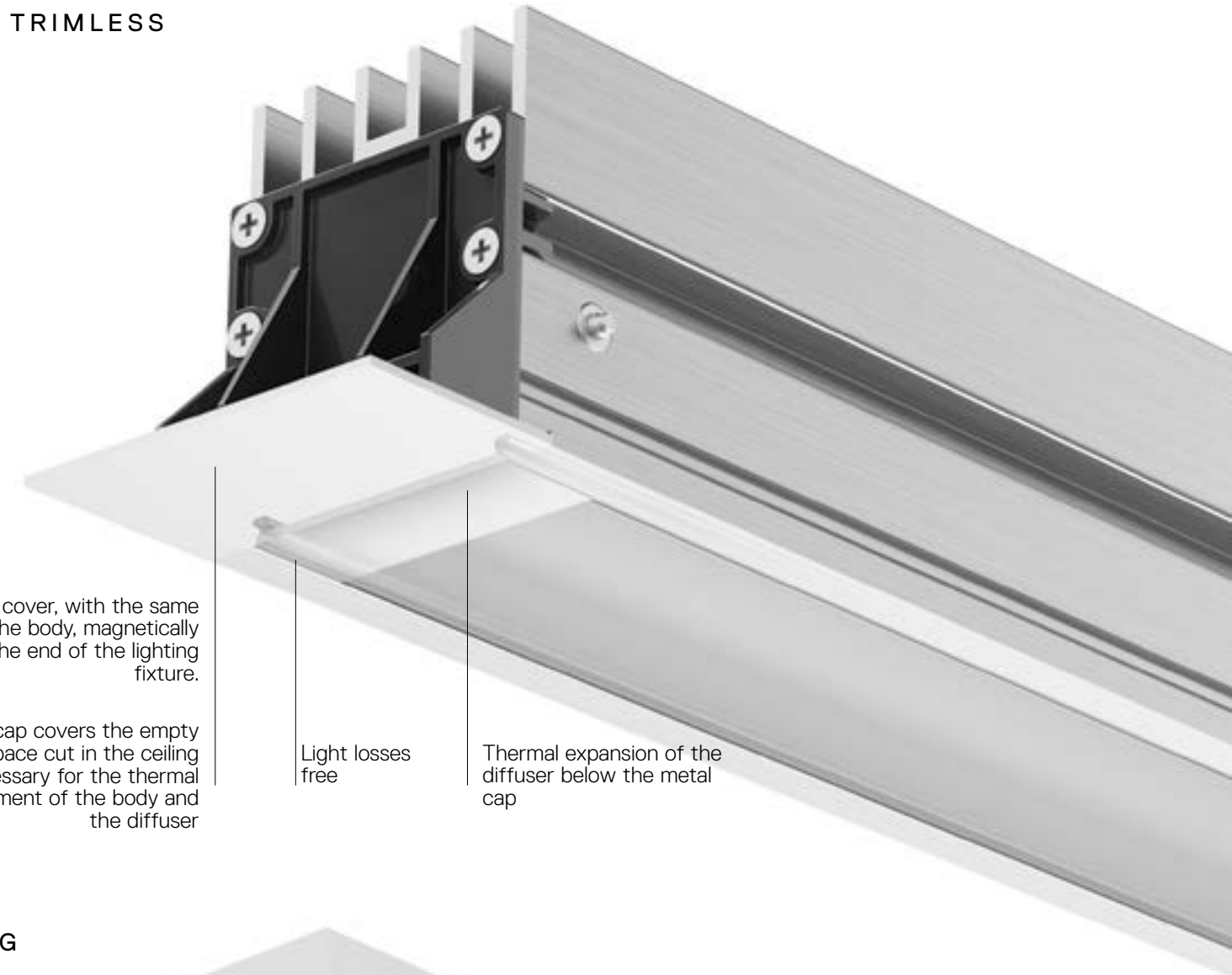

CEILING

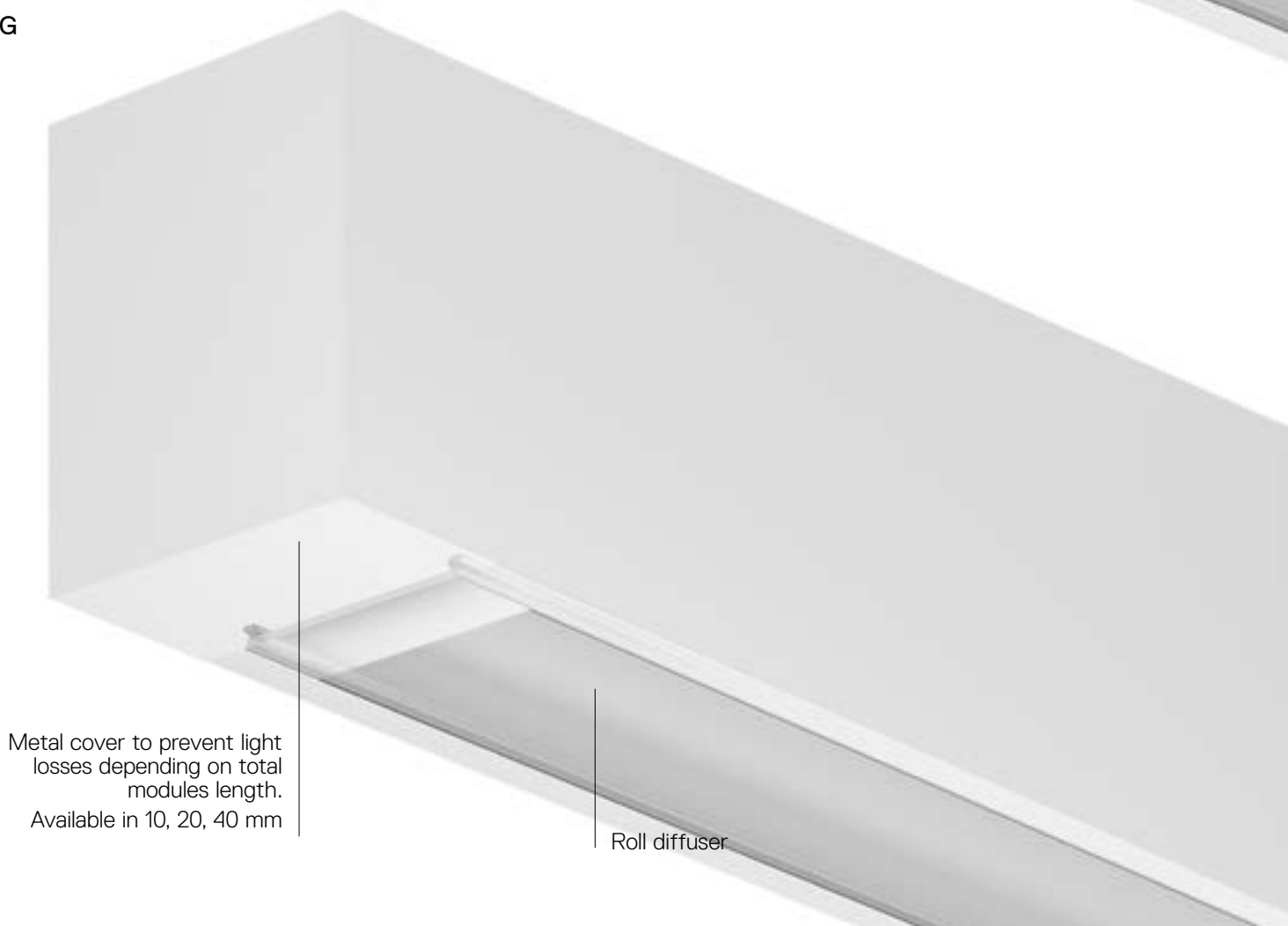

## ↪ A.39 RECESSED TRIMLESS - DIFFUSED EMISSION

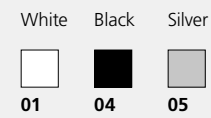

Opal diffuser supplied separately.  
APP interface supplied separately.  
The APP driver can not be controlled by DALI dimming system and viceversa.

MacAdam 2SDCM  
Life L70 (6K) 50000h  
CRI = 80  
\* Driver uses 1 DALI address

IP20

### Formwork (aluminum)

	Length	Code
Trimless module frame kit	1488 mm	AT04000
	2368 mm	AT04200
	4736 mm	AT04100
Trimless module frame cap (2 pcs)		AT09300
End cap (2 pcs)		AT09301
90° trimless frame kit L=303x303		AT30400

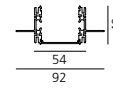

### Element Trimless

Length	W	Flux	CCT
1184 mm	33W	1981 lm	3000K
		2069 lm	4000K
1482 mm	41W	2476 lm	3000K
		2587 lm	4000K
1776 mm	49W	2971 lm	3000K
		3105 lm	4000K
2368 mm	63W	3962 lm	3000K
		4139 lm	4000K
2960 mm	81W	4952 lm	3000K
		5174 lm	4000K

### Undimmable

Code
AT00100
AT00300
AT00500
AT00700
AT02100
AT02300
AT01100
AT01300
AT01500
AT01700

### Dimmable DALI\*

Code
AT00000
AT00200
AT00400
AT00600
AT02000
AT02200
AT01000
AT01200
AT01400
AT01600

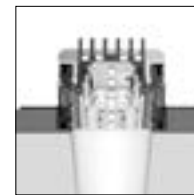

### Angle elements

	W	Flux	CCT
90° trimless	17W	1043 lm	3000K
recessed corner (on same plane)			4000K
303x303mm			

### Undimmable

Code
AT30500
AT30700

### Dimmable DALI\*

Code
AT30600
AT30800

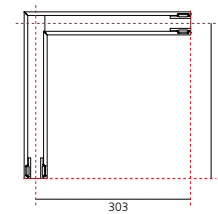

### Opal diffuser in polycarbonate (recessed)

Length	Code
1184 mm	AT10100
2368 mm	AT10200
2960 mm	AT10300
10000 mm roll	AT10000
25000 mm roll	AT10800
50000 mm roll	AT10900

### APP Interface

APP Code	
BLL interface for APP with antenna Up to 40 addresses	DV1054APP

## ↪ A.39 RECESSED TRIM - DIFFUSED EMISSION

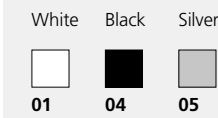

Opal diffuser supplied separately.  
APP interface supplied separately.  
The APP driver can not be controlled by DALI dimming system and viceversa.

MacAdam 2SDCM  
Life L70 (6K) 50000h  
CRI = 80  
\* Driver uses 1 DALI address

IP20

### Trim

Length	W	Flux	CCT
1184 mm	33W	2171 lm	3000K
		2269 lm	4000K
1482 mm	41W	2714 lm	3000K
		2836 lm	4000K
1776 mm	49W	3257 lm	3000K
		3403 lm	4000K
2368 mm	63W	4343 lm	3000K
		4538 lm	4000K
2960 mm	81W	5429 lm	3000K
		5673 lm	4000K

### Undimmable

Code
AT051. 01/04/05
AT053. 01/04/05
AT055. 01/04/05
AT057. 01/04/05
AT065. 01/04/05
AT068. 01/04/05
AT061. 01/04/05
AT063. 01/04/05
AT070. 01/04/05
AT072. 01/04/05

### Dimmable DALI\*

Code
AT050. 01/04/05
AT052. 01/04/05
AT054. 01/04/05
AT056. 01/04/05
AT064. 01/04/05
AT066. 01/04/05
AT060. 01/04/05
AT062. 01/04/05
AT069. 01/04/05
AT071. 01/04/05

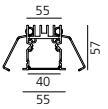
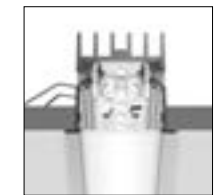

### Angle elements

	W	Flux	CCT
90° trim	17W	1086 lm	3000K
recessed corner (on same plane)			4000K
303x303mm			

### Undimmable

Code
AT300. 01/04/05
AT301. 01/04/05

### Dimmable DALI\*

Code
AT302. 01/04/05
AT303. 01/04/05

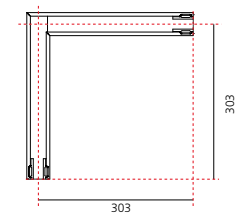

### Trim module end cap kit (2 pcs)

Code	
up to 5 m	AT090. 01/04/05
up to 15 m	AT091. 01/04/05
up to 35 m	AT092. 01/04/05

### Opal diffuser in polycarbonate (recessed)

Code	
Length	AT10100
1184 mm	AT10200
2368 mm	AT10300
2960 mm	AT10000
10000 mm rouleau	AT10800
25000 mm rouleau	AT10900
50000 mm rouleau	

### APP Interface

APP Code	
BLL interface for APP with antenna Up to 40 addresses	DV1054APP

## ↪ A.39 CEILING - DIFFUSED EMISSION

White Black Silver  
 01 04 05

Opal diffuser supplied separately.  
 APP interface supplied separately.  
 The APP driver can not be controlled by DALI dimming system and viceversa.

MacAdam 2SDCM  
 Life L70 (6K) 50000h  
 CRI = 80  
 \* Driver uses 1 DALI address

IP20

Ceiling direct emission			
Length	W	Flux	CCT
1184 mm	34W	2070 lm	3000K
		2163 lm	4000K
1482 mm	42W	2588 lm	3000K
		2704 lm	4000K
2368 mm	66W	4141 lm	3000K
		4326 lm	4000K
2960 mm	82W	5176 lm	3000K
		5408 lm	4000K

Undimmable	
Code	
AT131.	01/04/05
AT133.	01/04/05
AT141.	01/04/05
AT143.	01/04/05
AT151.	01/04/05
AT153.	01/04/05
AT181.	01/04/05
AT183.	01/04/05

Dimmable DALI*	
Code	
AT130.	01/04/05
AT132.	01/04/05
AT140.	01/04/05
AT142.	01/04/05
AT150.	01/04/05
AT152.	01/04/05
AT180.	01/04/05
AT182.	01/04/05

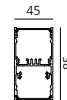
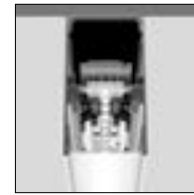

Angle elements			
	W	Flux	CCT
90° corner direct emission (on same plane) 303x303mm	17W	1081 lm	3000K 4000K

Dimmable DALI*	
Code	
AT350.	01/04/05
AT351.	01/04/05

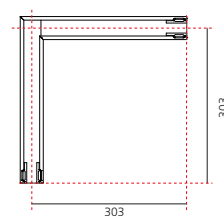

Accessories	
	Code
End cap kit (2 pcs)	AT094. 01/04/05
Ceiling bracket and mechanical joint	AT09501
End ceiling bracket (2 pcs)	AT09502

Opal diffuser in polycarbonate	
Length	Code
1184 mm	AT09505
2368 mm	AT09506
2960 mm	AT09507
10000 mm roll	AT10000
25000 mm roll	AT10800
50000 mm roll	AT10900

APP Interface	
	APP Code
BLL interface for APP with antenna Up to 40 addresses	DV1054APP

## ↪ A.39 SUSPENSION - DIFFUSED EMISSION

White Black Silver  
 01 04 05

Opal diffuser supplied separately.  
 APP interface supplied separately.  
 The APP driver can not be controlled by DALI dimming system and viceversa.

MacAdam 2SDCM  
 Life L70 (6K) 50000h  
 CRI = 80  
 \* Driver uses 1 DALI address  
 \*\* Drivers use 2 DALI addresses

IP20

Suspension, ceiling direct emission			
Length	W	Flux	CCT
1184 mm	34W	2070 lm	3000K
		2163 lm	4000K
1482 mm	42W	2588 lm	3000K
		2704 lm	4000K
2368 mm	66W	4141 lm	3000K
		4326 lm	4000K
2960 mm	82W	5176 lm	3000K
		5408 lm	4000K

Undimmable	
Code	
AT131.	01/04/05
AT133.	01/04/05
AT141.	01/04/05
AT143.	01/04/05
AT151.	01/04/05
AT153.	01/04/05
AT181.	01/04/05
AT183.	01/04/05

Dimmable DALI*	
Code	
AT130.	01/04/05
AT132.	01/04/05
AT140.	01/04/05
AT142.	01/04/05
AT150.	01/04/05
AT152.	01/04/05
AT180.	01/04/05
AT182.	01/04/05

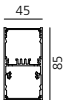
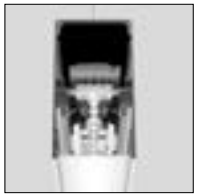

Suspension direct + indirect emission			
Length	W	Flux	CCT
1184 mm	34W direct	2070 lm direct	3000K
	23W indirect	2956 lm indirect	
		2163 lm direct	4000K
1482 mm	42W direct	2588 lm direct	3000K
	31W indirect	3941 lm indirect	
		2704 lm direct	4000K
2368 mm	66W direct	4141 lm direct	3000K
	50W indirect	5912 lm indirect	
		4326 lm direct	4000K
2960 mm	82W direct	5176 lm direct	3000K
	67W indirect	7883 lm indirect	
		5408 lm direct	4000K
		8236 lm indirect	

Undimmable	
Code	
AT193.	01/04/05
AT221.	01/04/05
AT223.	01/04/05
AT231.	01/04/05
AT233.	01/04/05
AT241.	01/04/05
AT243.	01/04/05

Dimmable DALI	
Code	
*AT190.	01/04/05
*AT192.	01/04/05
*AT220.	01/04/05
*AT222.	01/04/05
**AT230.	01/04/05
**AT232.	01/04/05
**AT240.	01/04/05
**AT242.	01/04/05

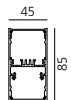
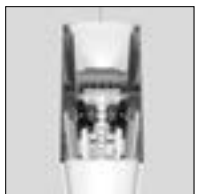

Angle elements			
	W	Flux	CCT
90° corner direct emission (on same plane) 303x303mm	17W	1081 lm	3000K 4000K

Dimmable DALI*	
Code	
AT350.	01/04/05
AT351.	01/04/05

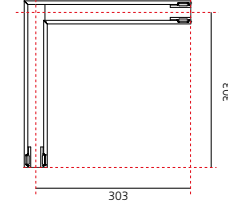

Accessories suspension	
	Code
Undimmable Feeding kit including 2 suspension cables 2000h mm (3 poles)	AT10400
Dimmable or APP Feeding kit including 2 suspension cables 2000h mm (5 poles)	AT10500 AT10500APP
Mechanical joint including 1 suspension cable	AT09500
End cap kit 2x	AT094. 01/04/05

Opal diffuser in polycarbonate (suspension, ceiling)	
Length	Code
1184 mm	AT09505
2368 mm	AT09506
2960 mm	AT09507
10000 mm roll	AT10000
25000 mm roll	AT10800
50000 mm roll	AT10900

A.39  
↳ sharpening

→ TRIMLESS

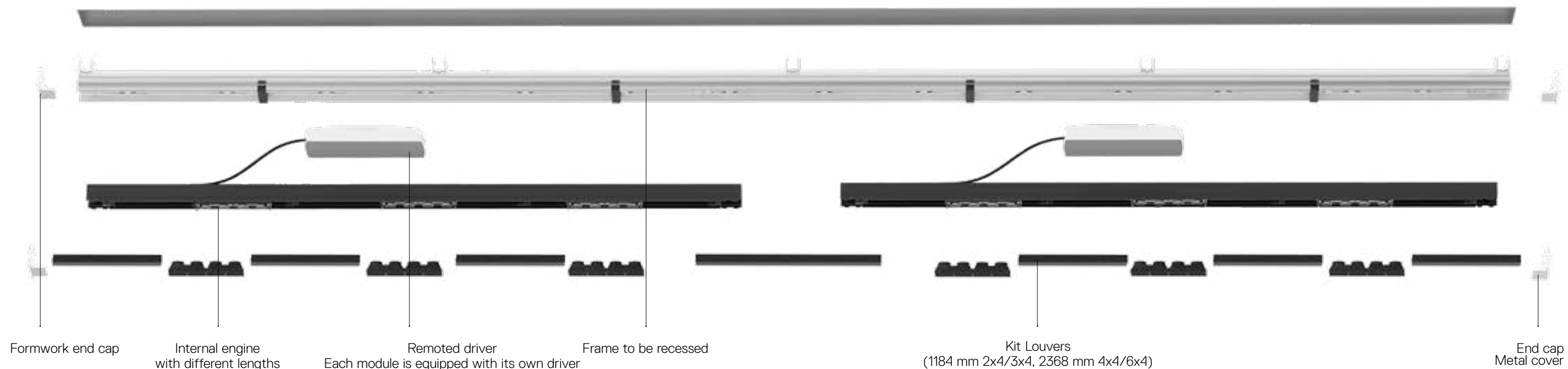

# A.39 sharpening recessed components

→ TRIM

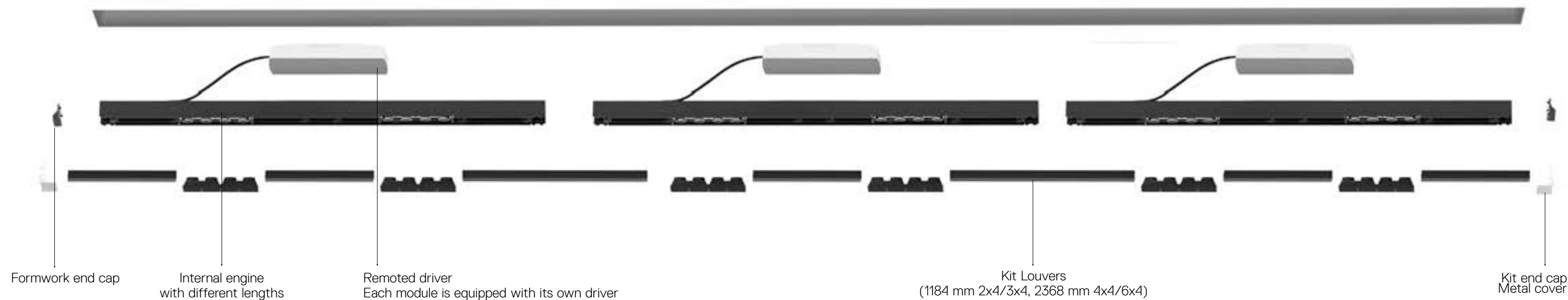

→ CEILING

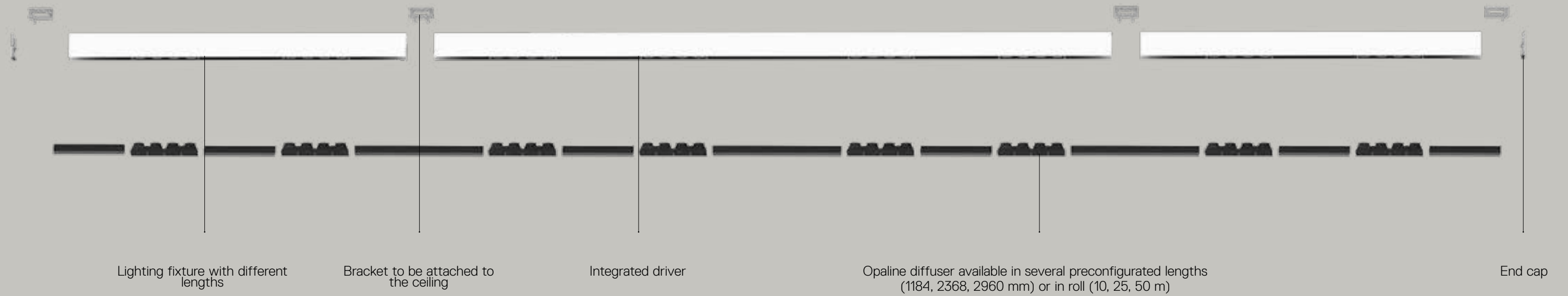

# A.39 sharpening ceiling, suspension components

→ SUSPENSION

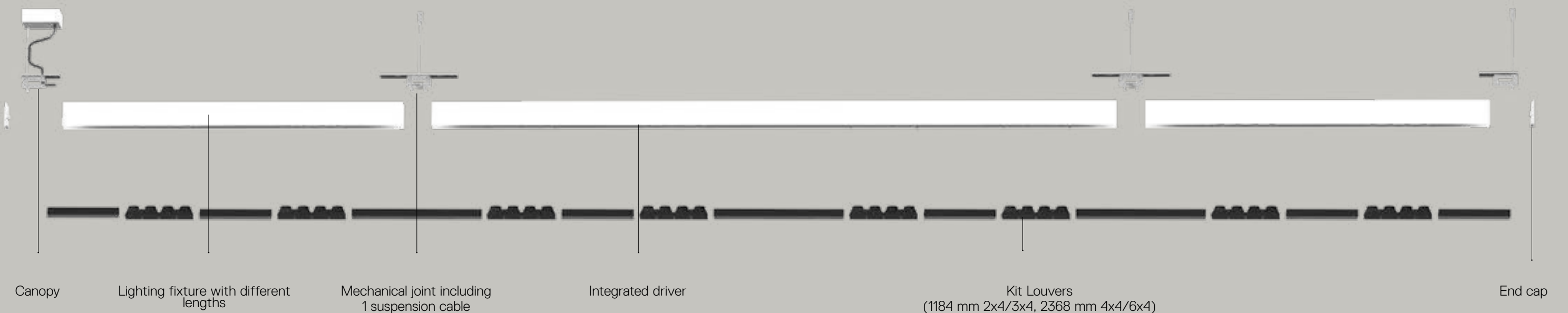



↪ A.39 RECESSED TRIMLESS - SHARPING EMISSION

White 01 Black 04 S F XF Louvers supplied separately. Driver 900mA SELV supplied separately. APP interface supplied separately. The APP driver can not be controlled by DALI dimming system and viceversa.

MacAdam 2SDCM L90 (20K) 118000h CRI >90 \* Driver uses 1 DALI address IP20

Formwork (aluminum)	
Trimless recessed frame	
Length 1184	
Length 2368	
Trimless frame end cap (2 pcs)	
90° trimless formwork kit	
L=57x57 mm	

Code
BH30400
BH30500
BH30700
BH31101

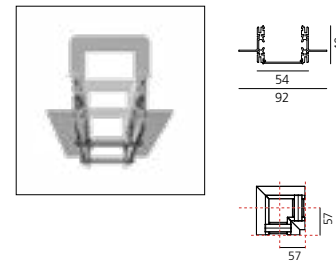

Trimless						
Length	Optic	W LED	Beam	Flux	CCT	
1184 mm	2x4 optics	22 W	S 20°	1648 lm	3000 K	
			F 36°	1764 lm	4000 K	
			XF 52°	1542 lm	3000 K	
	3x4 optics	33 W	S 20°	1651 lm	4000 K	
			F 36°	1597 lm	3000 K	
			XF 52°	1709 lm	4000 K	
			S 20°	2473 lm	3000 K	
			F 36°	2646 lm	4000 K	
			XF 52°	2314 lm	3000 K	
2368 mm	4x4 optics	44 W	S 20°	2396 lm	3000 K	
			F 36°	2564 lm	4000 K	
			XF 52°	2476 lm	4000 K	
			S 20°	3297 lm	3000 K	
			F 36°	3528 lm	4000 K	
			XF 52°	3085 lm	3000 K	
	6x4 optics	66 W	S 20°	3301 lm	4000 K	
			F 36°	3195 lm	3000 K	
			XF 52°	3419 lm	4000 K	
			S 20°	4945 lm	3000 K	
			F 36°	5292 lm	4000 K	
			XF 52°	4627 lm	3000 K	
				S 20°	4952 lm	4000 K
				F 36°	4792 lm	3000 K
				XF 52°	5128 lm	4000 K

Code
BH24001
BH24101
BH24201
BH24301
BH24401
BH24501
BH25001
BH25101
BH25201
BH25301
BH25401
BH25501
BH26001
BH26101
BH26201
BH26301
BH26401
BH26501
BH27001
BH27101
BH27201
BH27301
BH27401
BH27501

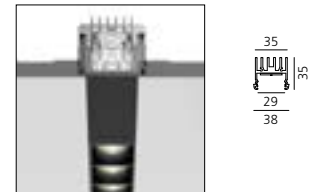

Covers (not lit)	
	90° corner covers L=57x57 mm
Code	BH440. 01/04

Louvers	
Length	Optic
1184 mm	2x4 optics
	3x4 optics
2368 mm	4x4 optics
	6x4 optics
Code	AE400. 01/04
	AE410. 01/04
	AE420. 01/04
	AE430. 01/04

Optional accessories	
	Sharping wall grazer lens Kit (4pcs) 26°x70° elliptical lenses kit. It has to be used on top of S 20° reflectors to get an elliptical beam (greater axis along the module length). It contains 4 lenses.
Code	AF06000

Driver		
Optic units	W	Vac
1184 mm (2x4)	25 W 900mA	220-240
1184 mm (3x4)	45 W 900mA	220-240
2368 mm (4x4)	60 W 900mA	220-240
2368 mm (6x4) - order 2 pcs	45 W 900mA	220-240

Undimmable	DALI*	APP
Code	Code	Code
DV1022	DV1026	DV1053APP
DV1023	DV1027	DV1053APP
DV1024	DV1028	DV1053APP
DV1023	DV1029	DV1053APP (2x)

↪ A.39 RECESSED TRIM - SHARPING EMISSION

White 01 Black 04 Silver 05 S F XF Louvers supplied separately. Driver 900mA SELV supplied separately. APP interface supplied separately. The APP driver can not be controlled by DALI dimming system and viceversa.

MacAdam 2SDCM Life L90 (20K) 118000h CRI >90 \* Driver uses 1 DALI address IP20

Trim						
Length	Optic	W LED	Beam	Flux	CCT	
1184 mm	2x4 optics	22 W	S 20°	1648 lm	3000 K	
			F 36°	1764 lm	4000 K	
			XF 52°	1542 lm	3000 K	
	3x4 optics	33 W	S 20°	1651 lm	4000 K	
			F 36°	1597 lm	3000 K	
			XF 52°	1709 lm	4000 K	
			S 20°	2473 lm	3000 K	
			F 36°	2646 lm	4000 K	
			XF 52°	2314 lm	3000 K	
2368 mm	4x4 optics	44 W	S 20°	2396 lm	3000 K	
			F 36°	2564 lm	4000 K	
			XF 52°	2476 lm	4000 K	
			S 20°	3297 lm	3000 K	
			F 36°	3528 lm	4000 K	
			XF 52°	3085 lm	3000 K	
	6x4 optics	66 W	S 20°	3301 lm	4000 K	
			F 36°	3195 lm	3000 K	
			XF 52°	3419 lm	4000 K	
			S 20°	4945 lm	3000 K	
			F 36°	5292 lm	4000 K	
			XF 52°	4627 lm	3000 K	
				S 20°	4952 lm	4000 K
				F 36°	4792 lm	3000 K
				XF 52°	5128 lm	4000 K

Code
BH200. 01/04/05
BH201. 01/04/05
BH202. 01/04/05
BH203. 01/04/05
BH204. 01/04/05
BH205. 01/04/05
BH210. 01/04/05
BH211. 01/04/05
BH212. 01/04/05
BH213. 01/04/05
BH214. 01/04/05
BH215. 01/04/05
BH220. 01/04/05
BH221. 01/04/05
BH222. 01/04/05
BH223. 01/04/05
BH224. 01/04/05
BH225. 01/04/05
BH230. 01/04/05
BH231. 01/04/05
BH232. 01/04/05
BH233. 01/04/05
BH234. 01/04/05
BH235. 01/04/05

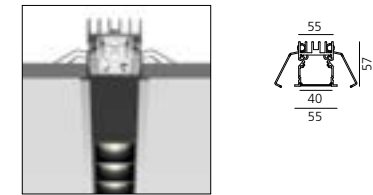

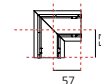
Angle elements (not lit)	
	90° trim recessed corner (on same plane) L=57x57 mm
Code	BH310. 01/04

Covers (not lit)	
	90° corner covers L=57x57 mm
Code	BH440. 01/04

Components	
Trim module end cap kit (2 pcs)	Code
up to 5 m	AT090. 01/04/05
up to 15 m	AT091. 01/04/05
up to 35 m	AT092. 01/04/05

Louvers	
Length	Optic
1184 mm	2x4 optics
	3x4 optics
2368 mm	4x4 optics
	6x4 optics
Code	AE400. 01/04
	AE410. 01/04
	AE420. 01/04
	AE430. 01/04

Optional accessories	
	Sharping wall grazer lens Kit (4pcs) 26°x70° elliptical lenses kit. It has to be used on top of S 20° reflectors to get an elliptical beam (greater axis along the module length). It contains 4 lenses.
Code	AF06000

Driver		
Optic units	W	Vac
1184 mm (2x4)	25 W 900mA	220-240
1184 mm (3x4)	45 W 900mA	220-240
2368 mm (4x4)	60 W 900mA	220-240
2368 mm (6x4) - order 2 pcs	45 W 900mA	220-240

Undimmable	DALI*	APP
Code	Code	Code
DV1022	DV1026	DV1053APP
DV1023	DV1027	DV1053APP
DV1024	DV1028	DV1053APP
DV1023	DV1029	DV1053APP (2x)



## ↪ A.39 CEILING - SHARPING EMISSION

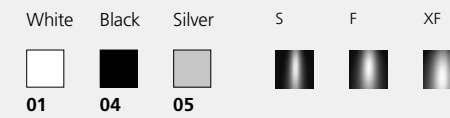

Louvers supplied separately.  
APP interface supplied separately.  
APP interface supplied separately.  
The APP driver can not be controlled by DALI dimming system and viceversa.

MacAdam 2SDCM  
Life L90 (20K) 118000h  
CRI >90  
\*Uses 1 DALI address  
\*\*Uses 2 DALI address

IP20  
Ⓢ

Direct emission					
Length	Optic	W	Beam	Flux	CCT
1184 mm	2x4 optics	25 W	S 20°	1648 lm	3000 K
				1764 lm	4000 K
			F 36°	1542 lm	3000 K
				1651 lm	4000 K
			XF 52°	1597 lm	3000 K
				1709 lm	4000 K
2368 mm	3x4 optics	38 W	S 20°	2473 lm	3000 K
				2646 lm	4000 K
			F 36°	2314 lm	3000 K
				2476 lm	4000 K
			XF 52°	2396 lm	3000 K
				2564 lm	4000 K
2368 mm	4x4 optics	50 W	S 20°	3297 lm	3000 K
				3528 lm	4000 K
			F 36°	3085 lm	3000 K
				3301 lm	4000 K
			XF 52°	3195 lm	3000 K
				3419 lm	4000 K
2368 mm	6x4 optics	80 W	S 20°	4945 lm	3000 K
				5292 lm	4000 K
			F 36°	4627 lm	3000 K
				4952 lm	4000 K
			XF 52°	4792 lm	3000 K
				5128 lm	4000 K

Undimmable Code	Dimmable DALI* Code
BH040. 01/04/05	BH042. 01/04/05
BH041. 01/04/05	BH043. 01/04/05
BH044. 01/04/05	BH046. 01/04/05
BH045. 01/04/05	BH047. 01/04/05
BH048. 01/04/05	BH050. 01/04/05
BH049. 01/04/05	BH051. 01/04/05
BH000. 01/04/05	BH002. 01/04/05
BH001. 01/04/05	BH003. 01/04/05
BH004. 01/04/05	BH006. 01/04/05
BH005. 01/04/05	BH007. 01/04/05
BH008. 01/04/05	BH010. 01/04/05
BH009. 01/04/05	BH011. 01/04/05
BH060. 01/04/05	BH062. 01/04/05
BH061. 01/04/05	BH063. 01/04/05
BH064. 01/04/05	BH066. 01/04/05
BH065. 01/04/05	BH067. 01/04/05
BH068. 01/04/05	BH070. 01/04/05
BH069. 01/04/05	BH071. 01/04/05
Dimmable DALI**	
BH020. 01/04/05	BH022. 01/04/05
BH021. 01/04/05	BH023. 01/04/05
BH024. 01/04/05	BH026. 01/04/05
BH025. 01/04/05	BH027. 01/04/05
BH028. 01/04/05	BH030. 01/04/05
BH029. 01/04/05	BH031. 01/04/05

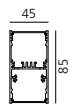

Angle elements (not lit)
90° suspension/ceiling corner (on same plane) L=57x57 mm

Code  
BH350. 01/04/05



Covers (not lit)
90° corner covers L=57x57 mm

Code  
BH440. 01/04



Louvers	Code
Length	Optic
1184 mm	2x4 optics
	3x4 optics
2368 mm	4x4 optics
	6x4 optics

Accessories ceiling	Code
End caps (2 pcs)	BH164. 01/04/05
Ceiling bracket and mechanical joint	AT09501
End ceiling bracket (2 pcs)	AT09502

Optional accessories	APP Interface	APP
 Sharpening wall grazer lens Kit (4pcs) 26°x70° elliptical lenses kit. It has to be used on top of S 20° reflectors to get an elliptical beam (greater axis along the module length). It contains 4 lenses.	Code AF06000 BLL interface for APP with antenna Up to 40 addresses	Code DV1054APP

## ↪ A.39 SUSPENSION - SHARPING EMISSION

White Black Silver S F XF Louvers supplied separately. MacAdam 2SDCM IP20  
 01 04 05 APP interface supplied separately. Life L90 (20K) 118000h  
 The APP driver can not be controlled by DALI dimming system and viceversa. CRI >90  
 \*Uses 1 DALI address

Direct emission						Undimmable		Dimmable DALI*		
Length	Optic	W	Beam	Flux	CCT	Code	Code	Code	Code	
1184 mm*2x4 optics	27 W	S 20°	1648 lm direct	3000 K	<b>BH040.</b> 01/04/05	<b>BH042.</b> 01/04/05				
			1764 lm	4000 K	<b>BH041.</b> 01/04/05	<b>BH043.</b> 01/04/05				
			F 36°	1542 lm	3000 K	<b>BH044.</b> 01/04/05	<b>BH046.</b> 01/04/05			
			1651 lm	4000 K	<b>BH045.</b> 01/04/05	<b>BH047.</b> 01/04/05				
			XF 52°	1597 lm	3000 K	<b>BH048.</b> 01/04/05	<b>BH050.</b> 01/04/05			
			1709 lm	4000 K	<b>BH049.</b> 01/04/05	<b>BH051.</b> 01/04/05				
	3x4 optics	38 W	S 20°	2473 lm	3000 K	<b>BH000.</b> 01/04/05	<b>BH002.</b> 01/04/05			
				2646 lm	4000 K	<b>BH001.</b> 01/04/05	<b>BH003.</b> 01/04/05			
				F 36°	2314 lm	3000 K	<b>BH004.</b> 01/04/05	<b>BH006.</b> 01/04/05		
				2476 lm	4000 K	<b>BH005.</b> 01/04/05	<b>BH007.</b> 01/04/05			
				XF 52°	2396 lm	3000 K	<b>BH008.</b> 01/04/05	<b>BH010.</b> 01/04/05		
				2564 lm	4000 K	<b>BH009.</b> 01/04/05	<b>BH011.</b> 01/04/05			
2368 mm 4x4 optics	54 W	S 20°	3297 lm	3000 K	<b>BH060.</b> 01/04/05	<b>BH062.</b> 01/04/05				
			3528 lm	4000 K	<b>BH061.</b> 01/04/05	<b>BH063.</b> 01/04/05				
			F 36°	3085 lm	3000 K	<b>BH064.</b> 01/04/05	<b>BH066.</b> 01/04/05			
			3301 lm	4000 K	<b>BH065.</b> 01/04/05	<b>BH067.</b> 01/04/05				
			XF 52°	3195 lm	3000 K	<b>BH068.</b> 01/04/05	<b>BH070.</b> 01/04/05			
			3419 lm	4000 K	<b>BH069.</b> 01/04/05	<b>BH071.</b> 01/04/05				
	70 W DALI	75 W Undimmable	S 20°	4945 lm	3000 K	<b>BH020.</b> 01/04/05	<b>BH022.</b> 01/04/05			
				5292 lm	4000 K	<b>BH021.</b> 01/04/05	<b>BH023.</b> 01/04/05			
				F 36°	4627 lm	3000 K	<b>BH024.</b> 01/04/05	<b>BH026.</b> 01/04/05		
				4952 lm	4000 K	<b>BH025.</b> 01/04/05	<b>BH027.</b> 01/04/05			
				XF 52°	4792 lm	3000 K	<b>BH028.</b> 01/04/05	<b>BH030.</b> 01/04/05		
				5128 lm	4000 K	<b>BH029.</b> 01/04/05	<b>BH031.</b> 01/04/05			

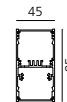

### Angle elements (not lit)

90° suspension/ceiling corner  
(on same plane)  
L=57x57 mm



Code  
**BH350.** 01/04/05

### Covers (not lit)

90° corner covers  
57x57mm



Code  
**BH440.** 01/04

### Louvers

Length	Optic
1184 mm	2x4 optics
	3x4 optics
2368 mm	4x4 optics
	6x4 optics

Code  
**AE400.** 01/04  
**AE410.** 01/04  
**AE420.** 01/04  
**AE430.** 01/04

### Optional accessories

Sharping wall grazer lens Kit (4pcs)  
26°x70° elliptical lenses kit. It has to be used on top of S 20° reflectors to get an elliptical beam (greater axis along the module length). It contains 4 lenses.



Code  
**AF06000**

### Accessories suspension

Mechanical joint including 1 suspension cable

Code  
**AT09500**

End caps kit (2 pcs)

**BH164.** 01/04/05

Undimmable Feeding kit including 2 suspension cables (3 poles) 2000h mm

**AT10400**

Dimmable or APP Feeding kit including 2 suspension cables (5 poles) 2000h mm

**AT10500**  
**AT10500APP**

White Black Silver S F XF Louvers supplied separately. MacAdam 2SDCM IP20  
 01 04 05 APP interface supplied separately. Life L90 (20K) 118000h  
 The APP driver can not be controlled by DALI dimming system and viceversa. CRI >90  
 \*\* Uses 2 DALI addresses

Direct and Indirect emission						Undimmable		Dimmable DALI**	
Length	Optic	W	Beam	Flux	CCT	Code	Code	Code	Code
1184 mm 2x4 optics	27 W direct	S 20°	1648 lm direct	3000 K	<b>BH120.</b> 01/04/05	<b>BH122.</b> 01/04/05			
			1764 lm direct	4000 K	<b>BH121.</b> 01/04/05	<b>BH123.</b> 01/04/05			
			2956 lm indirect						
			1764 lm direct	4000 K	<b>BH124.</b> 01/04/05	<b>BH126.</b> 01/04/05			
			3089 lm indirect						
			F 36°	1542 lm direct	3000 K	<b>BH125.</b> 01/04/05	<b>BH127.</b> 01/04/05		
	26 W indirect	XF 52°	1597 lm direct	3000 K	<b>BH128.</b> 01/04/05	<b>BH130.</b> 01/04/05			
			1709 lm direct	4000 K	<b>BH129.</b> 01/04/05	<b>BH131.</b> 01/04/05			
			2956 lm indirect						
			1650 lm direct	4000 K	<b>BH124.</b> 01/04/05	<b>BH126.</b> 01/04/05			
			3089 lm indirect						
			F 36°	1542 lm direct	3000 K	<b>BH125.</b> 01/04/05	<b>BH127.</b> 01/04/05		
3x4 optics 38 W direct	26 W indirect	S 20°	2473 lm direct	3000 K	<b>BH080.</b> 01/04/05	<b>BH082.</b> 01/04/05			
			2956 lm indirect						
			2646 lm direct	4000 K	<b>BH081.</b> 01/04/05	<b>BH083.</b> 01/04/05			
			3089 lm indirect						
			F 36°	2314 lm direct	3000 K	<b>BH084.</b> 01/04/05	<b>BH086.</b> 01/04/05		
			2956 lm indirect						
	70 W direct DALI	75 W direct Undimmable	S 20°	4945 lm direct	3000 K	<b>BH085.</b> 01/04/05	<b>BH087.</b> 01/04/05		
				5292 lm direct	4000 K	<b>BH088.</b> 01/04/05	<b>BH090.</b> 01/04/05		
				4627 lm direct	3000 K	<b>BH089.</b> 01/04/05	<b>BH091.</b> 01/04/05		
				4952 lm direct	4000 K	<b>BH092.</b> 01/04/05	<b>BH094.</b> 01/04/05		
				4792 lm direct	3000 K	<b>BH093.</b> 01/04/05	<b>BH095.</b> 01/04/05		
				5128 lm direct	4000 K	<b>BH096.</b> 01/04/05	<b>BH098.</b> 01/04/05		
2368 mm 4x4 optics	54 W direct	S 20°	3297 lm direct	3000 K	<b>BH140.</b> 01/04/05	<b>BH142.</b> 01/04/05			
			5912 lm indirect						
			3528 lm direct	4000 K	<b>BH141.</b> 01/04/05	<b>BH143.</b> 01/04/05			
			6177 lm indirect						
			F 36°	3085 lm direct	3000 K	<b>BH144.</b> 01/04/05	<b>BH146.</b> 01/04/05		
			5912 lm indirect						
	50 W indirect	XF 52°	3195 lm direct	3000 K	<b>BH148.</b> 01/04/05	<b>BH150.</b> 01/04/05			
			3419 lm direct	4000 K	<b>BH149.</b> 01/04/05	<b>BH151.</b> 01/04/05			
			6177 lm indirect						
			4945 lm direct	3000 K	<b>BH100.</b> 01/04/05	<b>BH102.</b> 01/04/05			
			5912 lm indirect						
			5292 lm direct	4000 K	<b>BH101.</b> 01/04/05	<b>BH103.</b> 01/04/05			
6x4 optics	70 W direct DALI	S 20°	4945 lm direct	3000 K	<b>BH104.</b> 01/04/05	<b>BH106.</b> 01/04/05			
			5912 lm indirect						
			5292 lm direct	4000 K	<b>BH105.</b> 01/04/05	<b>BH107.</b> 01/04/05			
			6177 lm indirect						
			4627 lm direct	3000 K	<b>BH108.</b> 01/04/05	<b>BH110.</b> 01/04/05			
			4952 lm direct	4000 K	<b>BH109.</b> 01/04/05	<b>BH111.</b> 01/04/05			
	50 W indirect	XF 52°	4792 lm direct	3000 K	<b>BH104.</b> 01/04/05	<b>BH106.</b> 01/04/05			
			5912 lm indirect						
			5128 lm direct	4000 K	<b>BH108.</b> 01/04/05	<b>BH110.</b> 01/04/05			
			6177 lm indirect						
			4627 lm direct	3000 K	<b>BH104.</b> 01/04/05	<b>BH106.</b> 01/04/05			
			4952 lm direct	4000 K	<b>BH105.</b> 01/04/05	<b>BH107.</b> 01/04/05			

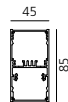

### Angle elements (not lit)

90° suspension corner  
(on same plane)  
L=57x57 mm



Code  
**BH350.** 01/04/05

### Covers (not lit)

90° corner covers  
L=57x57 mm



Code  
**BH440.** 01/04

### Louvers

Length	Optic
1184 mm	2x4 optics
	3x4 optics
2368 mm	4x4 optics
	6x4 optics

Code  
**AE400.** 01/04  
**AE410.** 01/04  
**AE420.** 01/04  
**AE430.** 01/04

### Accessories suspension

Mechanical joint including 1 suspension cable

Code  
**AT09500**

End caps kit 2x

**BH164.** 01/04/05

### Optional accessories

Sharping wall grazer lens Kit (4pcs)  
26°x70° elliptical lenses kit. It has to be used on top of S 20° reflectors to get an elliptical beam (greater axis along the module length). It contains 4 lenses.



Code  
**AF06000**

Undimmable Feeding kit including 2 suspension cables (3 poles) 2000h mm

**AT10400**

Dimmable or APP Feeding kit including 2 suspension cables (5 poles) 2000h mm

**AT10500**  
**AT10500APP**



**Controlled emission LED optic System  
UGR index control and 65°  
luminance (EN 12464)**

Patent-pending proprietary optic system made by a thin black square-meshed grid and by a system of square plano-convex lenses of appropriate beam angle. The internal part of the grid is white painted and has a high reflection coefficient, so that the light incident on the grid is retrieved within the body.

A net 'cut off' at the required angle is obtained through this system.

The convex profile of the lens is designed with images optic techniques, so that the emission is limited within the 65° required by standard EN 12464.

UGR<19

Angle luminance equals to 65° and beyond: <3,000 cd/m2.

→ Patent pending

**Operating diagram of the optical device used:**

The grid positioned over the lenses allows only the rays falling into the required output angular limits to be incident to the lenses.

The rays beyond these limits are recovered and redirected inside the light box (if the ray is incident to the white surface) or cancelled (if the ray is incident to the black edge).

**Functioning scheme**

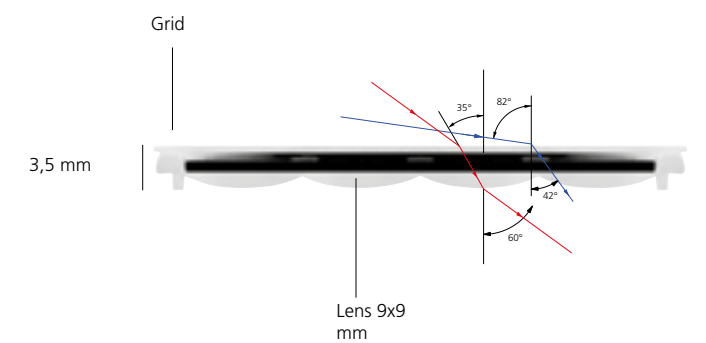

# A.39

## ↳ controlled emission



light ON

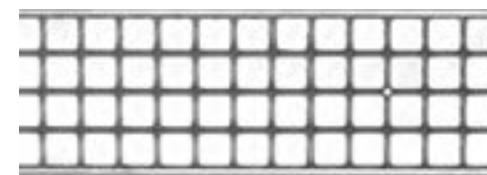

light OFF

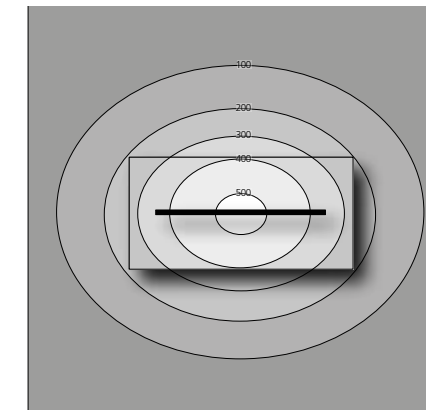

Direct emission

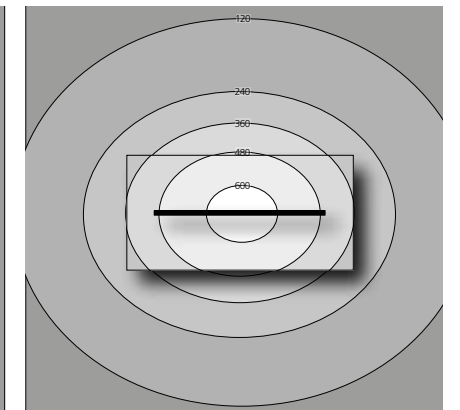

Direct emission + indirect

CEILING

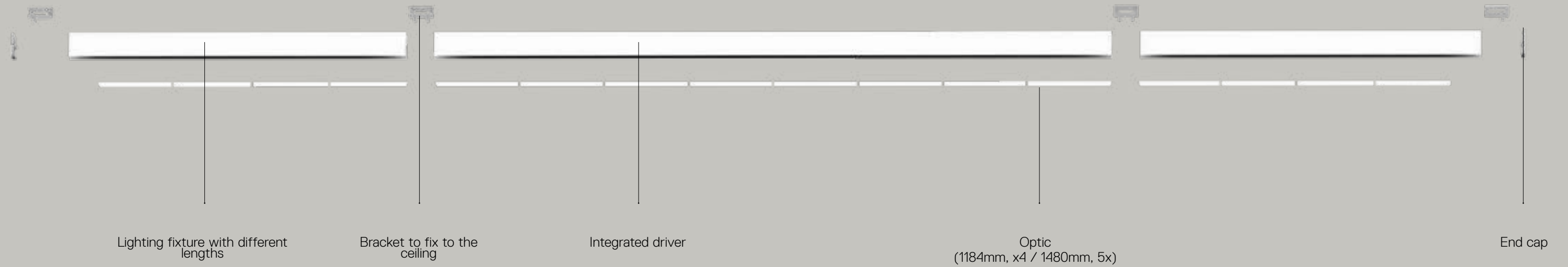

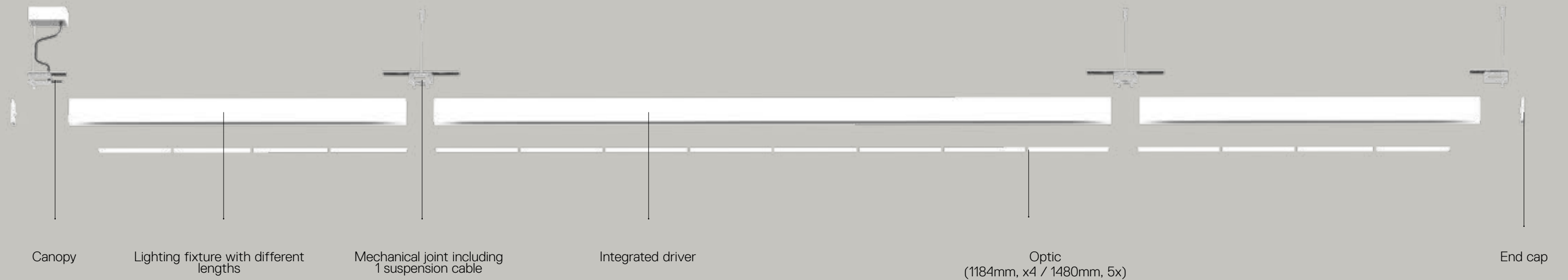

# A.39 controlled emission ceiling, suspension components

→ SUSPENSION



# A.39 controlled emission space fittings

## ↪ A.39 SUSPENSION, CEILING CONTROLLED EMISSION

White	Black	Silver
		
01	04	05

Screens supplied separately.  
APP interface supplied separately.  
The APP driver can not be controlled by DALI dimming system and viceversa.

MacAdam 2SDCM  
Life L70 (6K) 50000h  
CRI =80  
\*Uses 1 DALI address  
\*\*Uses 2 DALI address

IP20  
Ⓢ

Suspension, ceiling direct emission			
Length	W	Flux	CCT
1184 mm	34W	1955 lm	3000K
		2043 lm	4000K
1482 mm	42W	2444 lm	3000K
		2554 lm	4000K
2368 mm	66W	3911 lm	3000K
		4086 lm	4000K
2960 mm	82W	4889 lm	3000K
		5108 lm	4000K

Undimmable
Code
AT135. 01/04/05
AT137. 01/04/05
AT145. 01/04/05
AT147. 01/04/05
AT155. 01/04/05
AT157. 01/04/05
AT185. 01/04/05
AT187. 01/04/05

Dimmable DALI*
Code
AT134. 01/04/05
AT136. 01/04/05
AT144. 01/04/05
AT146. 01/04/05
AT154. 01/04/05
AT156. 01/04/05
AT184. 01/04/05
AT186. 01/04/05

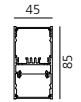
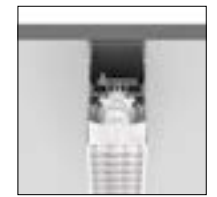

Suspension direct + indirect emission			
Length	W	Flux	CCT
1184 mm	34W direct 23W indirect	1955 lm direct	3000K
		2956 lm indirect	
		2043 lm direct 3088 lm indirect	4000K
1482 mm	42W direct 31W indirect	2444 lm direct	3000K
		3941 lm indirect	
		2554 lm direct 4118 lm indirect	4000K
2368 mm	66W direct 50W indirect	3911 lm direct	3000K
		5912 lm indirect	
		4086 lm direct 6177 lm indirect	4000K
2960 mm	82W direct 67W indirect	4889 lm direct	3000K
		7883 lm indirect	
		5108 lm direct 8236 lm indirect	4000K

Undimmable
Code
AT195. 01/04/05
AT197. 01/04/05
AT225. 01/04/05
AT227. 01/04/05
AT235. 01/04/05
AT237. 01/04/05
AT245. 01/04/05
AT247. 01/04/05

Dimmable DALI
Code
*AT194. 01/04/05
*AT196. 01/04/05
*AT224. 01/04/05
*AT226. 01/04/05
**AT234. 01/04/05
**AT236. 01/04/05
**AT244. 01/04/05
**AT246. 01/04/05

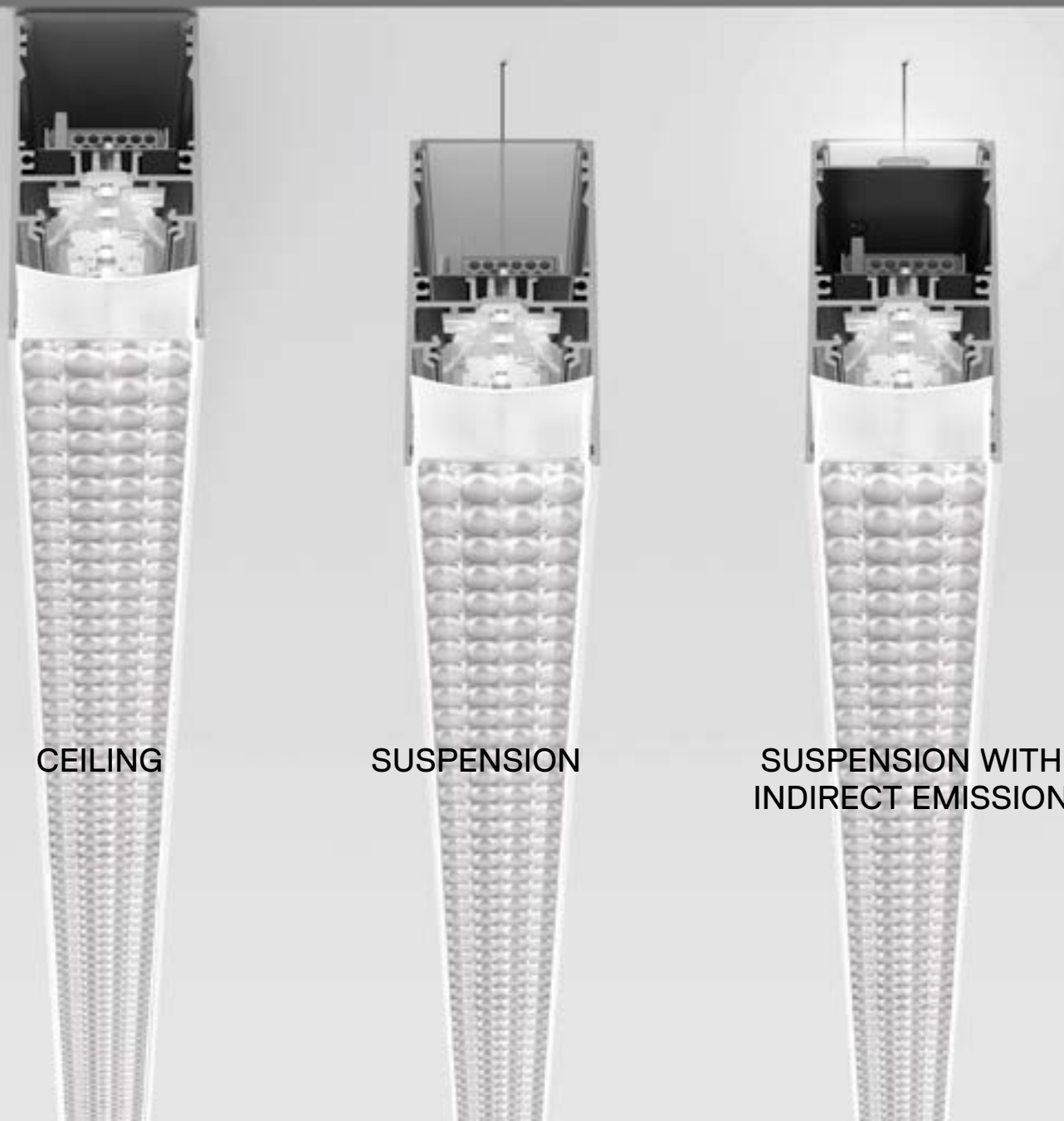
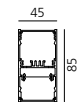
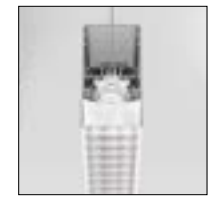

Optic
Length
1184 mm (4 pcs)
1480 mm (5 pcs)

Code
M186700
AT09900

Length	Screen quantity to order
1184 mm	1 M186700
1482 mm	1 AT09900
2368 mm	2 M186700
2960 mm	2 AT09900

### Angle elements (not lit)

90° suspension corner  
(on same plane)  
L=57x57 mm



Code
AT310. 01/04/05

### Accessories suspension

Undimmable Feeding kit including 2 suspension cables 2000h mm (3 poles)

Dimmable or APP Feeding kit including 2 suspension cables 2000h mm (5 poles)

Mechanical joint including 1 suspension cable

End cap kit 2x

Code
AT10400
AT10500
AT10500APP
AT09500
AT098. 01/04/05

### Accessories ceiling

End cap kit (2 pcs)

Ceiling bracket and mechanical joint

End ceiling bracket (2 pcs)

BLL interface for APP with antenna  
Up to 40 addresses

Code
AT098. 01/04/05
AT09501
AT09502
DV1054APP

# Algoritmo

Carlotta de Bevilacqua  
Paola di Arianello  
↪ 2010



# Algoritmo typologies

## Algoritmo Installation

**Algoritmo System**  
wall- or ceiling recessed

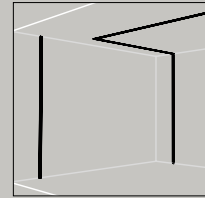

## LED emission

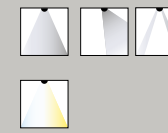

## LED emission + LED indirect



## Accent lighting



Direct emission white diffused or wall washer.  
Direct emission white LED prismoptic and controlled emission.  
Direct emission TW LED.  
Accent lighting.

**Algoritmo System**  
Wall/ceiling  
surface-mounted  
configurations, linear  
or at a 90 degree angle.

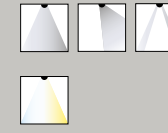
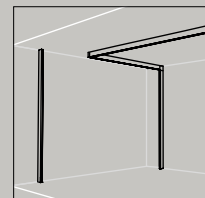

Direct emission white diffused or wall washer.  
Direct emission white LED prismoptic and controlled emission.  
Direct emission TW LED.  
Accent lighting.

**Algoritmo System**  
Suspension  
Linear or at a 90 degree  
angle installations.

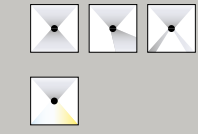
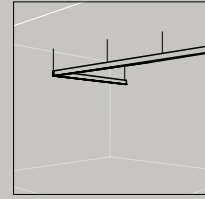

Direct emission white diffused or wall washer.  
Direct emission white LED prismoptic or controlled emission.  
Direct emission TW LED.  
Direct emission white LED prismoptic or controlled emission and indirect emission diffused white LED.  
Direct emission TW LED and indirect emission white LED diffused.  
Direct emission white LED and indirect emission diffused white LED.  
Accent lighting.

**Algoritmo Stand-alone**  
Suspension  
Surface-mounted  
ceiling installation.

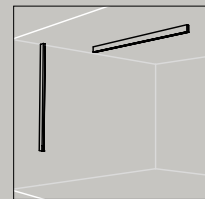
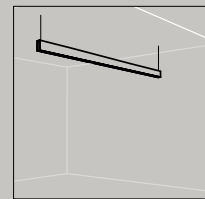

Direct emission white LED diffused.  
Direct and indirect emission white LED diffused.



For further information on Algoritmo  
↪ visit [artemide.com](http://artemide.com)



**Artemide  
App**  
↪ on request







CEILING  
SUSPENSION



RECESSED  
WITH TRIM



RECESSED  
TRIMLESS

# Algoritmo space fittings

# Algoritmo colors

White



01

White Black Silver



20



10



90

Silver



05

Black



04



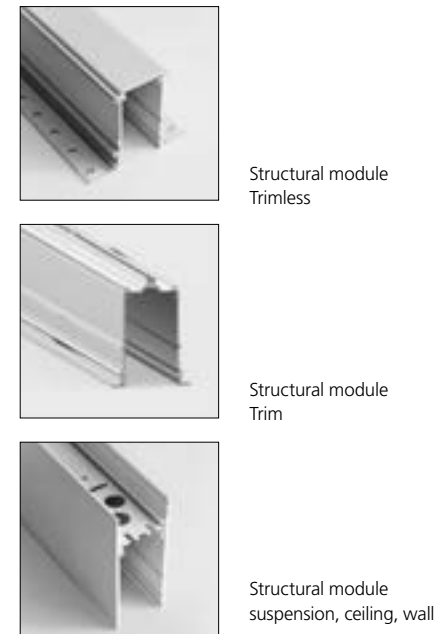

Algoritmo system is particularly flexible; it allows different lighting solutions to be coupled through the same shared electrical system. LED diffused or wall washer in warm (3000 K) or neutral white (4000 K), LED controlled and prismatic, accent lighting.

Installation in line or at a 90° angle.

Algoritmo system is composed of:

- Structural modules in extruded aluminium, available in different lengths depending on the installation option and 3 finishes, white, black and silver.
- Gear plates with through-wiring and rapid connectors.
- Supplementary through-wiring with rapid connection.
- Optical systems: diffusers, controlled optics for LED, wall washer optics for LED, 3 white LED monochromatic projectors (Pad, Pad square and 37 cube).
- End caps and joints.
- Supplying cables.
- Pre-cabLED white LED (MV) plates equipped with electronic or electronic dimmerable driver (DALI).
- Power supply and LED management systems (LV) to be ordered separately.

Compliant with standard EN60598-1 and other specific standards.

SUSPENSION, CEILING, WALL				RECESSED				ELECTRICAL, OPTICAL, JUNCTION, SPOTLIGHTS, POWER SUPPLIES				
Fixing components	Junction components	Junction components	Pre-wired gear plates	Electrical Components	Optical systems	Junction components	Spotlights	Power supplies and control systems				

Algoritmo  
↪ diffused



## ↳ STRUCTURAL MODULE RECESSED

White Black Silver



Trimless		Code
Length	Weight	
1184 mm	1,80 kg	<b>M204800</b>
2368 mm	3,60 kg	<b>M204900</b>

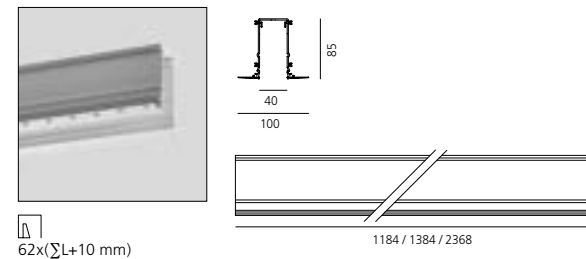

Trim		Code
Length	Weight	
1184 mm	1,80 kg	<b>M2934. 20/10/90</b>
2368 mm	3,60 kg	<b>M2935. 20/10/90</b>
3552 mm		<b>M2936. 20/10/90</b>
4736 mm		<b>M2937. 20/10/90</b>

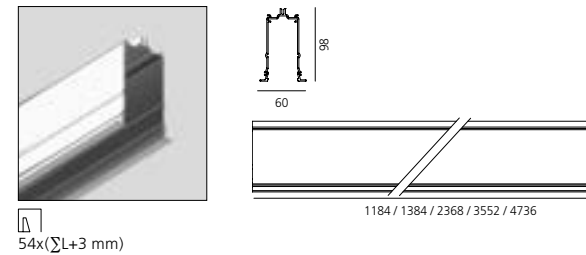

### Accessories trimless

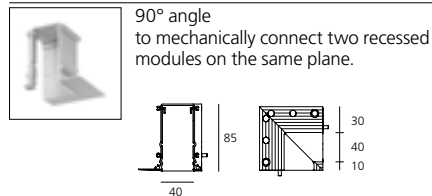

90° angle to mechanically connect two recessed modules on the same plane.

Code  
**M196600**

### Accessories trim

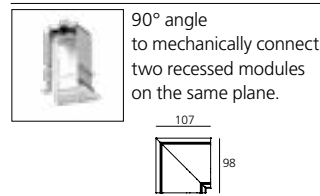

90° angle to mechanically connect two recessed modules on the same plane.

Code  
**M2939. 20/10/90**

End caps (set of 2)

**M197300**

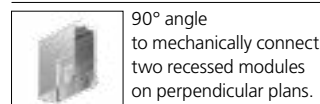

90° angle to mechanically connect two recessed modules on perpendicular plans.

**M2938. 20/10/90**

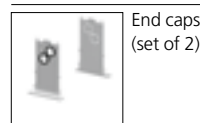

End caps (set of 2)

**M2940. 20/10/90**

## ↳ STRUCTURAL MODULE SUSPENSION, CEILING, WALL

White Black Silver Gloss anodised



		Code
Length	Weight	
1184 mm	2,30 kg	<b>M2050. 20/10/90</b>
2368 mm	4,60 kg	<b>M2051. 20/10/90</b>
3552 mm	6,90 kg	<b>M2063. 20/10/90</b>
4736 mm	9,20 kg	<b>M1995. 20/10/90</b>

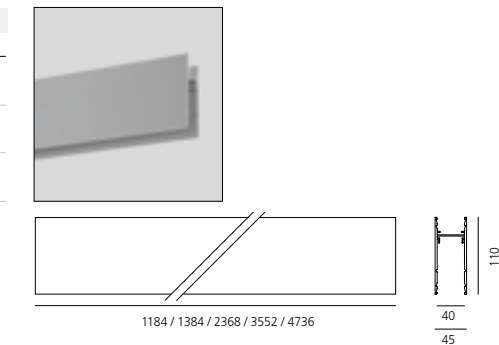

### Accessories

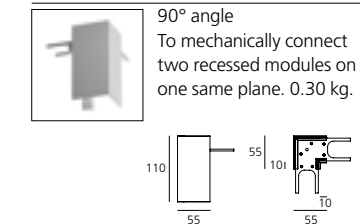

90° angle To mechanically connect two recessed modules on one same plane. 0.30 kg.

Code  
**M1968. 20/10**  
90  
60

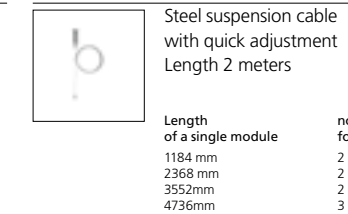

Steel suspension cable with quick adjustment Length 2 meters

Length of a single module	no. pieces required for each module
1184 mm	2
2368 mm	2
3552 mm	2
4736 mm	3

Code  
**M189100**  
  
Please check on Artemide.com for continuous system installations with 2+ connected modules.

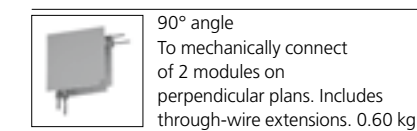

90° angle To mechanically connect of 2 modules on perpendicular plans. Includes through-wire extensions. 0.60 kg.

**M1967. 20/10**  
90  
60

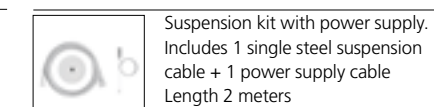

Suspension kit with power supply. Includes 1 single steel suspension cable + 1 power supply cable Length 2 meters

MV (5x1,5mm<sup>2</sup>+2x0,5mm<sup>2</sup>) To power white LED plates and accent modules.

**M189300**

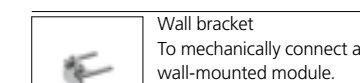

Wall bracket To mechanically connect a wall-mounted module.

**M199300**

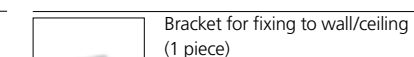

Bracket for fixing to wall/ceiling (1 piece)

Length of a single module	no. pieces required for each module
1184 mm	2
2368 mm	2
3552 mm	3
4736 mm	4

Applicable also for system installations.

**M1888. 20/10**  
90  
60

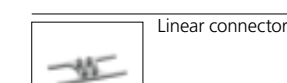

Linear connector

**M189000**

## WIRED GEAR PLATES WHITE LED

MV integrated through-cable.  
 \* Direct and indirect emission dimmable  
 Protection screen for indirect cabled LED plate included.  
 Occupies 2 DALI addresses

MacAdam 3SDC  
 Life L70 (12K) 72000h  
 CRI =80

IP20

Direct emission				DALI	
Length	W	Weight	CCT	Code	Code
1184 mm	34 W	1,10 kg	3000 K	<b>M2882W00</b>	<b>M2882W01</b>
			4000 K	<b>M2882N00</b>	<b>M2882N01</b>
2368 mm	68 W	2,00 kg	3000 K	<b>M2884W00</b>	<b>M2884W01</b>
			4000 K	<b>M2884N00</b>	<b>M2884N01</b>

Direct emission + indirect				Undimmable		DALI*	
Length	W	Weight	CCT	Code	Code	Code	Code
1184 mm	62 W	1,10 kg	3000 K	<b>M2883W00</b>	<b>M2883W01</b>	<b>M2883N01</b>	<b>M2883N01</b>
			4000 K	<b>M2883N00</b>	<b>M2883N01</b>	<b>M2883N01</b>	<b>M2883N01</b>
2368 mm	122 W	2,00 kg	3000 K	<b>M2885W00</b>	<b>M2885W01</b>	<b>M2885N01</b>	<b>M2885N01</b>
			4000 K	<b>M2885N00</b>	<b>M2885N01</b>	<b>M2885N01</b>	<b>M2885N01</b>

### DIFFUSED EMISSION

Opal diffuser in polycarbonate	
Length	Weight
1184 mm	0,10 kg
2368 mm	0,20 kg
3552 mm	0,30 kg
4736 mm	0,40 kg

Code
<b>M197400</b>
<b>M186800</b>
<b>M203800</b>
<b>M197500</b>

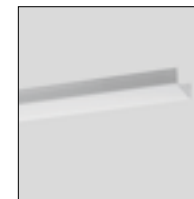

850°

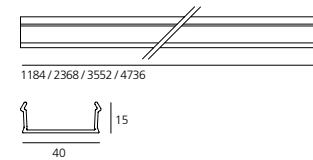

Direct emission			
Length	W	CCT	Flux
1184 mm	34 W	3000 K	1961 lm
		4000 K	2053 lm
2368 mm	68 W	3000 K	3921 lm
		4000 K	4106 lm

Direct emission + indirect			
Length	W	CCT	Flux
1184 mm	62 W	3000 K	4436 lm
		4000 K	4645 lm
2368 mm	122 W	3000 K	8872 lm
		4000 K	9289 lm

### WALL WASHER

Length	Weight
1184 mm	0,70 kg
2368 mm	1,40 kg

Code
<b>M217300</b>
<b>M217400</b>

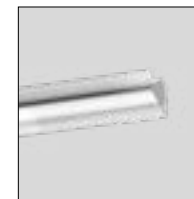

650°

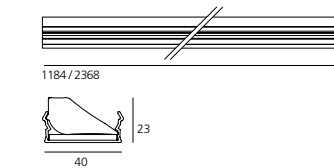

Direct emission			
Length	W	CCT	Flux
1184 mm	32 W	3000 K	2178 lm
		4000 K	2281 lm
2368 mm	65 W	3000 K	4357 lm
		4000 K	4561 lm

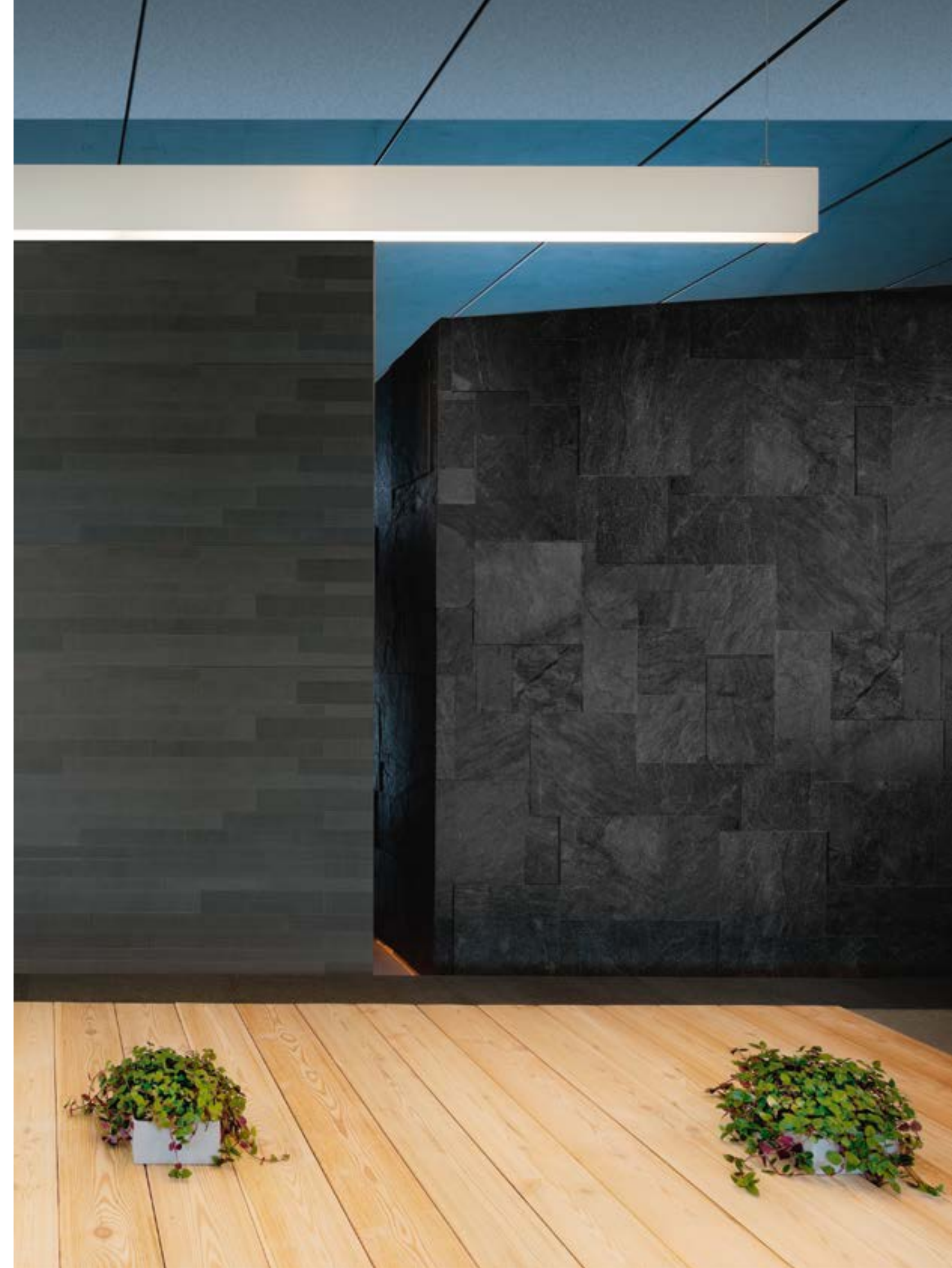

## ↔ ALGORITMO STAND-ALONE

\* Direct emission dimmable  
Protection screen for indirect cabled LED plate included.

MacAdam 3SDC  
Life L70 (12K) 72000h  
CRI =80

IP20  
850° direct  
650° direct/indirect

### SUSPENSION DIFFUSED EMISSION

Direct emission					Undimmable	DALI
W	Length	Weight	Flux	CCT	Code	Code
34 W	1188 mm	3,80 kg	1961 lm	3000 K	<b>M2910W20</b>	<b>M2910W21</b>
			2053 lm	4000 K	<b>M2910N20</b>	<b>M2910N21</b>
68 W	2372 mm	7,10 kg	3921 lm	3000 K	<b>M2912W20</b>	<b>M2912W21</b>
			4106 lm	4000 K	<b>M2912N20</b>	<b>M2912N21</b>



Direct + Indirect emission					Undimmable	DALI*
W	Length	Weight	Flux	CCT	Code	Code
62 W	1188 mm	3,80 kg	4436 lm	3000 K	<b>M2911W20</b>	<b>M2911W21</b>
			4645 lm	4000 K	<b>M2911N20</b>	<b>M2911N21</b>
122 W	2372 mm	7,10 kg	8872 lm	3000 K	<b>M2913W20</b>	<b>M2913W21</b>
			9289 lm	4000 K	<b>M2913N20</b>	<b>M2913N21</b>

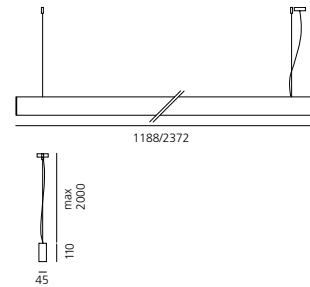

### WALL/CEILING DIFFUSED EMISSION

Direct emission					Undimmable	DALI*
W	Length	Weight	Flux	CCT	Code	Code
34 W	1188 mm	3,80 kg	1961 lm	3000 K	<b>M2914W20</b>	<b>M2914W21</b>
			2053 lm	4000 K	<b>M2914N20</b>	<b>M2914N21</b>
68 W	2372 mm	7,10 kg	3921 lm	3000 K	<b>M2915W20</b>	<b>M2915W21</b>
			4106 lm	4000 K	<b>M2915N20</b>	<b>M2915N21</b>

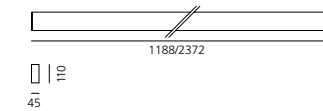



## ↳ PRE-WIRED GEAR FOR PAD AND PAD SQUARE PROJECTORS

Gloss anodised	S	F	WF	MacAdam 4SDCM Life L70 (12K)> 72000h CRI =80	IP40 650° -90° 90°
----------------	---	---	----	--	--------------------------

Direct emission		DALI	
Length	Weight	Code	
1184 mm	1,20 kg	<b>M217800</b>	

Allows installation and supplying of 1-4 PAD 230V projectors.  
MV through-wiring included.

Direct + indirect emission				Undimmable	DALI*
W	Length	Weight	CCT	Code	Code
27 W	1184 mm	1,20 kg	3000 K	<b>M2945W00</b>	<b>M2945W01</b>
			4000 K	<b>M2945N00</b>	<b>M2945N01</b>

Allows installation and powering of 1-4 PAD 230V + indirect projectors  
MV through-wiring included.  
\* Only indirect emission is dimmable.

Double emission version, with upper screen in PMMA.  
PAD projectors to be ordered separately.

PAD					Undimmable
W	Weight	Beam	Flux	CCT	Code
14,5 W	0,53 kg	S 12°	825 lm	3000 K	<b>M200002</b>
			880 lm	4000 K	<b>M200102</b>
		F 24°	825 lm	3000 K	<b>M200202</b>
			880 lm	4000 K	<b>M200302</b>
		WF 36°	805 lm	3000 K	<b>M200402</b>
			855 lm	4000 K	<b>M200502</b>

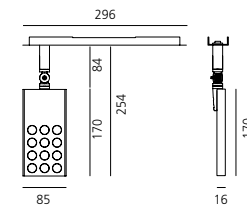

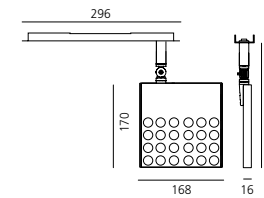

To be coupled with pre-wired gear plate.

PAD Square					Undimmable
W	Weight	Beam	Flux	CCT	Code
29 W	0,97 kg	S 12°	1650 lm	3000 K	<b>M201502</b>
			1750 lm	4000 K	<b>M201602</b>
		F 24°	1650 lm	3000 K	<b>M201702</b>
			1750 lm	4000 K	<b>M201802</b>
		WF 36°	1610 lm	3000 K	<b>M201902</b>
			1710 lm	4000 K	<b>M202002</b>



To be coupled with pre-wired gear plate.

Accessories		Code
	Blind panel, in polished metal grey steel. 1 piece required for each PAD empty position.	<b>M217760</b>
	Intermediate finishing cap (set of 2), in polished metal grey steel. To be used at the junction of PAD with LED modules.	<b>M217660</b>

## ↳ PRE-WIRED GEAR FOR 37 CUBE PROJECTORS

Gloss anodised	S	F	WF	MacAdam 4SDCM Life L70 (12K)> 72000h CRI =80	IP20 650° -90° 360°
----------------	---	---	----	--	---------------------------

Direct emission		DALI	
Length	Weight	Code	
1184 mm	1,20 kg	<b>M219601</b>	

Allows installation and supplying of 37 Cube, 1 or 2 groups of 3 projectors each. (max 6 projectors in total).  
MV through-wiring included.

Direct + indirect emission				DALI*
W	Length	Weight	CCT	Code
27 W	1184 mm	1,20 kg	3000 K	<b>M2198W01</b>
			4000 K	<b>M2198N01</b>

Allows installation and supplying of 37 Cube, 1 or 2 groups of 3 projectors each. (max 6 projectors in total).  
MV through-wiring included.  
\* Only indirect emission is dimmable.

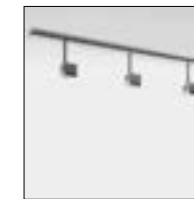

Double emission version, with upper screen in PMMA.  
37 Cube projectors to be ordered separately.

37 Cube					Undimmable
W	Weight	Beam	Flux	CCT	Code
3x8 W	0,47 kg	14°	3x483 lm	3000 K	<b>M029100</b>
			3x517 lm	4000 K	<b>M029400</b>
		18°	3x463 lm	3000 K	<b>M029200</b>
			3x495 lm	4000 K	<b>M029500</b>
		30°	3x468 lm	3000 K	<b>M029300</b>
			3x501 lm	4000 K	<b>M029600</b>

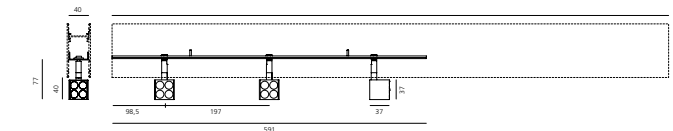

To be coupled with pre-wired gear plate.



Accessories		Code
	Blind panel, in polished metal grey steel. Length 591mm. 1 piece required for each 37 Cube empty position.	<b>M217560</b>
	Intermediate finishing cap (set of 2), in polished metal grey steel. To be used at the junction of 37 Cube modules with LED modules.	<b>M217660</b>

↪ PRE-WIRED GEAR TRAY FOR RAIL

White Black



Double emission version, with upper screen  
in PMMA.  
\* Only indirect emission is dimmable.

IP20

⊕  
650°

Direct rail			Undimmable Eutrac	DALI Eutrac
Length	Weight	Color rail	Code	Code
1184 mm	6,00 kg	white	<b>M294110</b>	<b>M294111</b>
		black	<b>M294120</b>	<b>M294121</b>
2368 mm	12,00 kg	white	<b>M294210</b>	<b>M294211</b>
		black	<b>M294220</b>	<b>M294221</b>

Direct rail+ indirect emission					Undimmable Eutrac	DALI Eutrac*
W	Length	Weight	CCT	Color rail	Code	Code
27 W	1184 mm	6,00 kg	3000 K	white	<b>M2943W10</b>	<b>M2943W11</b>
				black	<b>M2943W20</b>	<b>M2943W21</b>
			4000 K	white	<b>M2943N10</b>	<b>M2943N11</b>
				black	<b>M2943N20</b>	<b>M2943N21</b>
57 W	2368 mm	12,00 kg	3000 K	white	<b>M2944W10</b>	<b>M2944W11</b>
				black	<b>M2944W20</b>	<b>M2944W21</b>
			4000 K	white	<b>M2944N10</b>	<b>M2944N11</b>
				black	<b>M2944N20</b>	<b>M2944N21</b>





Algoritmo

↳ controlled emission  
prismoptic emission





↳ ALGORITMO CONTROLLED EMISSION

↳ ALGORITMO PRISMOPTIC EMISSION



**Controlled emission LED optic System**  
UGR index control and 65° luminance (EN 12464)

Patent-pending proprietary optic system made by a thin black square-meshed grid and by a system of square plano-convex lenses of appropriate beam angle. The internal part of the grid is white painted and has a high reflection coefficient, so that the light incident on the grid is retrieved within the body. A net 'cut off' at the required angle is obtained through this system. The convex profile of the lens is designed with images optic techniques, so that the emission is limited within the 65° required by standard EN 12464.

UGR<19  
Angle luminance equals to 65° and beyond: <3,000 cd/m<sup>2</sup>.

→ Patent pending

**Operating diagram of the optical device used:**

The grid positioned over the lenses allows only the rays falling into the required output angular limits to be incident to the lenses.

The rays beyond these limits are recovered and redirected inside the light box (if the ray is incident to the white surface) or cancelled (if the ray is incident to the black edge).

**Functioning scheme**

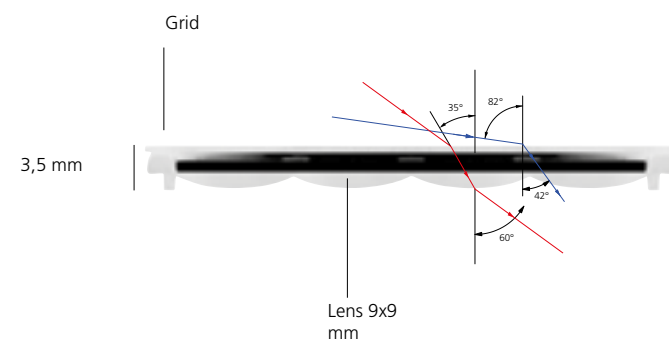

light ON

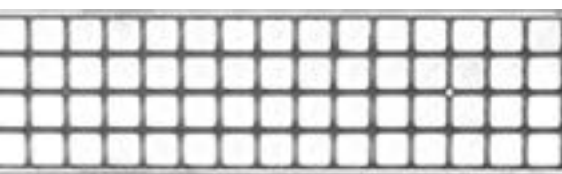

light OFF

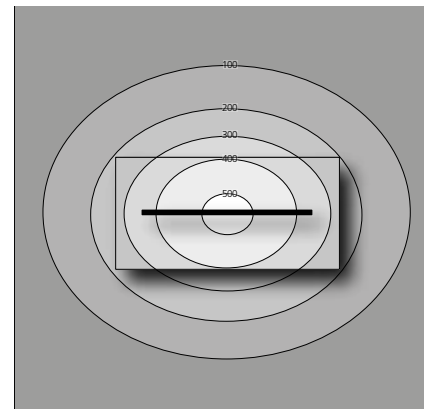

Direct emission

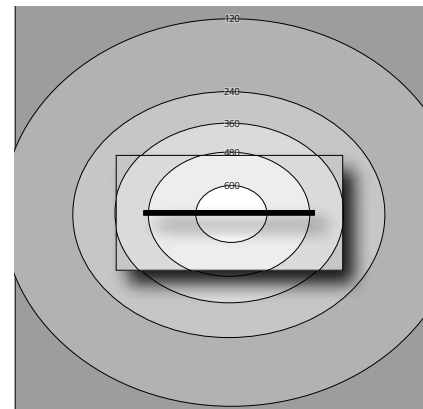

Direct emission + indirect

**Comfort emission**

The appliance is fitted with a clear plastic screen featuring an outer micro-prism pattern designed in order to obtain a focused luminous emission mostly within a 2x60° cone.

With this technology, Algoritmo Prismatic provides comfort lighting even when the appliance falls within the observer's visual cone.

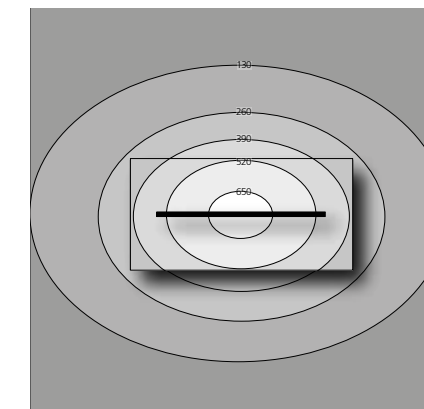

Direct emission

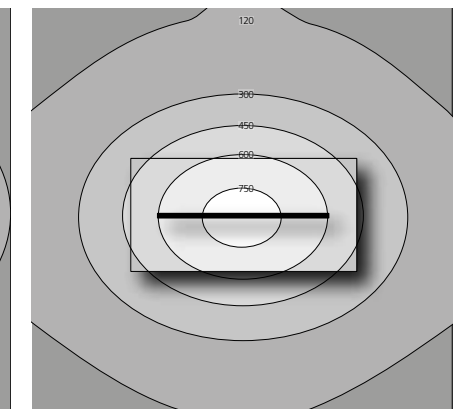

Direct emission + indirect

## ↳ STRUCTURAL MODULE RECESSED

White Black Silver



Trimless		Code
Length	Weight	
1184 mm	1,80 kg	<b>M204800</b>
2368 mm	3,60 kg	<b>M204900</b>

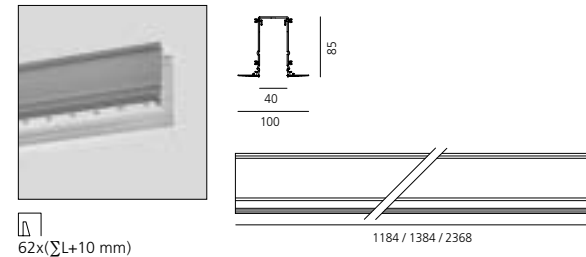

Trim		Code
Length	Weight	
1184 mm	1,80 kg	<b>M2934</b> . 20/10/90
2368 mm	3,60 kg	<b>M2935</b> . 20/10/90
3552 mm		<b>M2936</b> . 20/10/90
4736 mm		<b>M2937</b> . 20/10/90

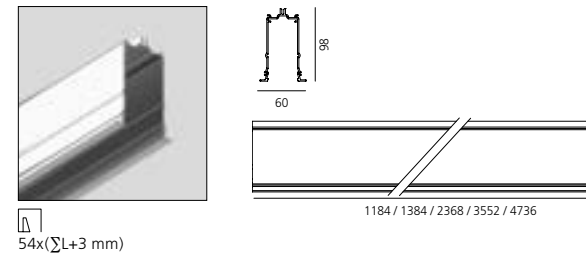

Accessories trimless	Code
<p>90° angle to mechanically connect two recessed modules on the same plane.</p>	<b>M196600</b>

Accessories trim	Code
<p>90° angle to mechanically connect two recessed modules on the same plane.</p>	<b>M2939</b> . 20/10/90

<p>End caps (set of 2)</p>	<b>M197300</b>
----------------------------	----------------

<p>90° angle to mechanically connect two recessed modules on perpendicular plans.</p>	<b>M2938</b> . 20/10/90
---	-------------------------

<p>End caps (set of 2)</p>	<b>M2940</b> . 20/10/90
----------------------------	-------------------------

## ↳ STRUCTURAL MODULE SUSPENSION, CEILING, WALL

White Black Silver Gloss anodised



		Code
Length	Weight	
1184 mm	2,30 kg	<b>M2050</b> . 20/10/90 60
2368 mm	4,60 kg	<b>M2051</b> . 20/10/90 60
3552 mm	6,90 kg	<b>M2063</b> . 20/10/90 60
4736 mm	9,20 kg	<b>M1995</b> . 20/10/90 60

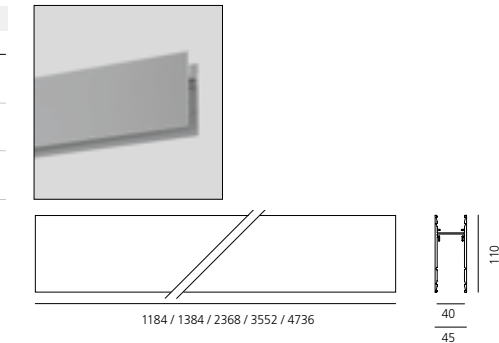

Accessories	Code
<p>90° angle To mechanically connect two recessed modules on one same plane. 0.30 kg.</p>	<b>M1968</b> . 20/10 90 60

		Code										
<p>Steel suspension cable with quick adjustment Length 2 meters</p>		<b>M189100</b>										
<table border="1"> <thead> <tr> <th>Length of a single module</th> <th>no. pieces required for each module</th> </tr> </thead> <tbody> <tr> <td>1184 mm</td> <td>2</td> </tr> <tr> <td>2368 mm</td> <td>2</td> </tr> <tr> <td>3552mm</td> <td>2</td> </tr> <tr> <td>4736mm</td> <td>3</td> </tr> </tbody> </table>	Length of a single module	no. pieces required for each module	1184 mm	2	2368 mm	2	3552mm	2	4736mm	3		Please check on Artemide.com for continuous system installations with 2+ connected modules.
Length of a single module	no. pieces required for each module											
1184 mm	2											
2368 mm	2											
3552mm	2											
4736mm	3											

<p>90° angle To mechanically connect of 2 modules on perpendicular plans. Includes through-wire extensions. 0.60 kg.</p>	<b>M1967</b> . 20/10 90 60
--	----------------------------------

<p>Suspension kit with power supply. Includes 1 single steel suspension cable + 1 power supply cable Length 2 meters</p>		
--	--	--

<p>Wall bracket To mechanically connect a wall-mounted module.</p>	<b>M199300</b>
--	----------------

<p>Bracket for fixing to wall/ceiling (1 piece)</p>		<b>M189300</b>
		MV (5x1,5mm2+2x0,5mm2) To power white LED plates and accent modules.

<p>End caps (set of 2)</p>	<b>M1888</b> . 20/10 90 60
----------------------------	----------------------------------

<table border="1"> <thead> <tr> <th>Length of a single module</th> <th>no. pieces required for each module</th> </tr> </thead> <tbody> <tr> <td>1184 mm</td> <td>2</td> </tr> <tr> <td>2368 mm</td> <td>2</td> </tr> <tr> <td>3552mm</td> <td>3</td> </tr> <tr> <td>4736mm</td> <td>4</td> </tr> </tbody> </table>	Length of a single module	no. pieces required for each module	1184 mm	2	2368 mm	2	3552mm	3	4736mm	4		Applicable also for system installations.
Length of a single module	no. pieces required for each module											
1184 mm	2											
2368 mm	2											
3552mm	3											
4736mm	4											

<p>Linear connector</p>	<b>M189000</b>
-------------------------	----------------

## ↳ WIRED GEAR PLATES WHITE LED

MV integrated through-cable.  
 \* Direct and indirect emission dimmable  
 Protection screen for indirect cabled LED plate included.  
 Occupies 2 DALI addresses

MacAdam 3SDC  
 Life L70 (12K)> 72000h  
 CRI =80

IP20

Direct emission				DALI	
Length	W	Weight	CCT	Code	Code
1184 mm	34 W	1,10 kg	3000 K	<b>M2882W00</b>	<b>M2882W01</b>
			4000 K	<b>M2882N00</b>	<b>M2882N01</b>
2368 mm	68 W	2,00 kg	3000 K	<b>M2884W00</b>	<b>M2884W01</b>
			4000 K	<b>M2884N00</b>	<b>M2884N01</b>

Direct emission + indirect				Undimmable		DALI*	
Length	W	Weight	CCT	Code	Code	Code	Code
1184 mm	62 W	1,10 kg	3000 K	<b>M2883W00</b>	<b>M2883W01</b>	<b>M2883N00</b>	<b>M2883N01</b>
			4000 K	<b>M2883N00</b>	<b>M2883N01</b>	<b>M2885W00</b>	<b>M2885W01</b>
2368 mm	122 W	2,00 kg	3000 K	<b>M2885W00</b>	<b>M2885W01</b>	<b>M2885N00</b>	<b>M2885N01</b>
			4000 K	<b>M2885N00</b>	<b>M2885N01</b>		

### CONTROLLED EMISSION

Length	Weight	Code
1184 mm	0,20 kg	<b>M186700</b>
2368 mm	0,40 kg	<b>M187300</b>

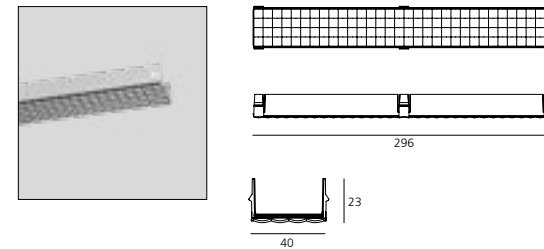

Direct emission				Direct emission + indirect			
Length	W	CCT	Flux	Length	W	CCT	Flux
1184 mm	34 W	3000 K	2527 lm	1184 mm	62 W	3000 K	5003 lm
		4000 K	2644 lm			4000 K	5238 lm
2368 mm	68 W	3000 K	5054 lm	2368 mm	122 W	3000 K	10005 lm
		4000 K	5292 lm			4000 K	10475 lm

### PRISMOPTIC

Length	Weight	Code
1184 mm	0,20 kg	<b>M196900</b>
2368 mm	0,40 kg	<b>M197000</b>

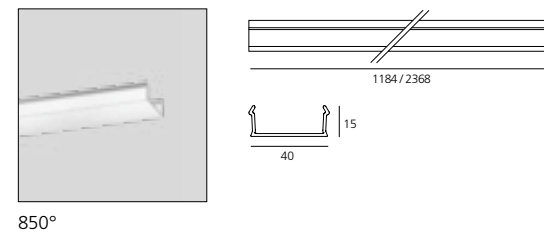

Direct emission				Direct emission + indirect			
Length	W	CCT	Flux	Length	W	CCT	Flux
1184 mm	34 W	3000 K	2527 lm	1184 mm	62 W	3000 K	5003 lm
		4000 K	2644 lm			4000 K	5238 lm
2368 mm	68 W	3000 K	5054 lm	2368 mm	122 W	3000 K	10005 lm
		4000 K	5292 lm			4000 K	10475 lm

## ↳ WIRED GEAR PLATES TUNABLE WHITE



MV integrated through-cable.  
 \* Direct and indirect emission dimmable  
 Protection screen for indirect cabled LED plate included.  
 Occupies 2 DALI addresses

MacAdam 3SDC  
 Life L70 (12K)> 72000h  
 CRI =80

IP20

Direct emission				Dimmable DALI 8	
Length	W	Weight	CCT	Code	Code
1184 mm	35 W	1,10 kg	2700 K - 5700 K	<b>M2990</b>	

Direct emission + indirect				Dimmable DALI 8	
Length	W	Weight	CCT	Code	Code
1184 mm	62 W	1,10 kg	2700 K - 5700 K	<b>M2991</b>	

### PRISMOPTIC

Length	Weight	Code
1184 mm	0,20 kg	<b>M196900</b>
2368 mm	0,40 kg	<b>M197000</b>

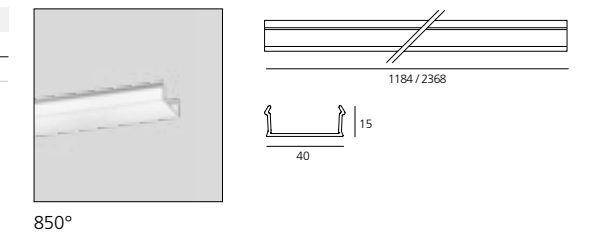

Direct emission			
Length	W	CCT	Flux
1184 mm	35 W	2700 K	1778 lm
		6500 K	1991 lm
2368 mm	62 W	2700 K	4024 lm
		6500 K	4507 lm





↳ A.Sharping



# A. Sharping optics

Algoritmo Sharping is very flexible and it allows to combine in continuity Sharp light modules, with indirect and diffused LED lighting in warm white (3000K) and neutral white (4000K).

Structural modules are in extruded aluminum, available in different lengths depending on the installation option, three finishes (white, black, silver or gloss anodized), two optic finishes (black and white) and three beams (17°, 34° and 54°).

→ Patent pending



OPTICAL UNITS 2X4



OPTICAL UNITS 3X4



OPTICAL UNITS 4X4



OPTICAL UNITS 6X4

# A. Sharping components

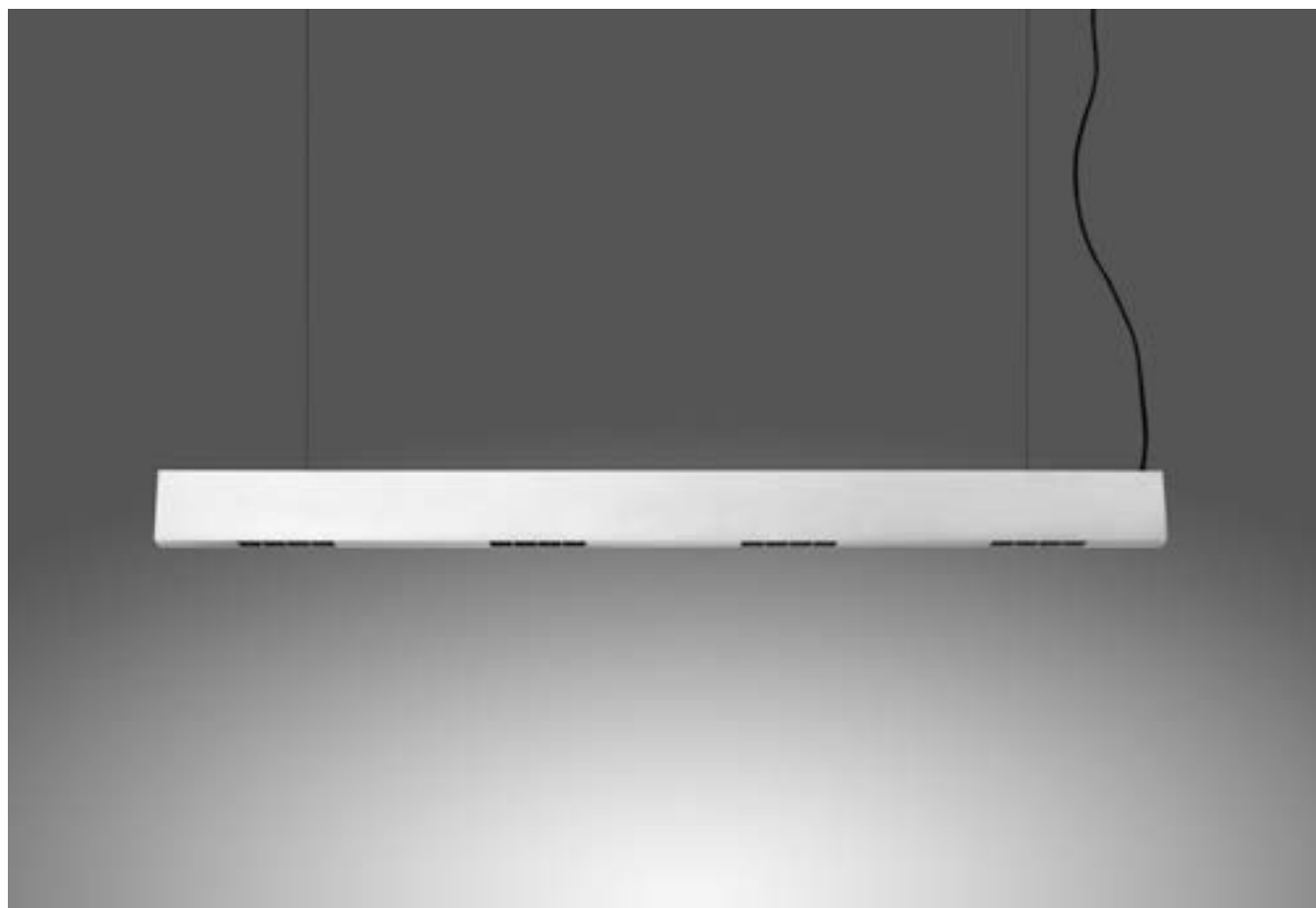

## ↳ STRUCTURAL MODULE RECESSED

White Black Silver



Trimless		Code
Length	Weight	
1184 mm	1,80 kg	<b>M204800</b>
2368 mm	3,60 kg	<b>M204900</b>

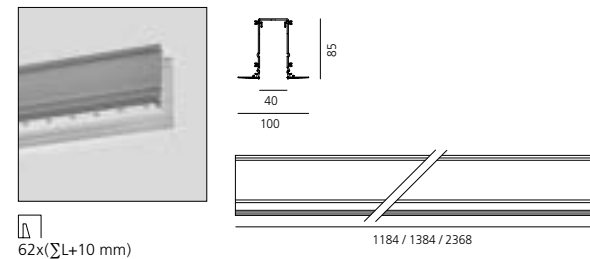

Trim		Code
Length	Weight	
1184 mm	1,80 kg	<b>M2934. 20/10/90</b>
2368 mm	3,60 kg	<b>M2935. 20/10/90</b>
3552 mm		<b>M2936. 20/10/90</b>
4736 mm		<b>M2937. 20/10/90</b>

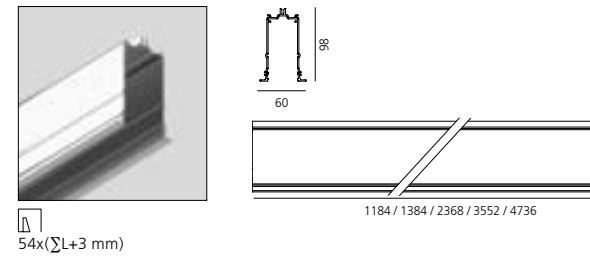

Accessories trimless	Code
<p>90° angle to mechanically connect two recessed modules on the same plane.</p>	<b>M196600</b>

Accessories trim	Code
<p>90° angle to mechanically connect two recessed modules on the same plane.</p>	<b>M2939. 20/10/90</b>

<p>End caps (set of 2)</p>	<b>M197300</b>
----------------------------	----------------

<p>90° angle to mechanically connect two recessed modules on perpendicular plans.</p>	<b>M2938. 20/10/90</b>
---	------------------------

<p>End caps (set of 2)</p>	<b>M2940. 20/10/90</b>
----------------------------	------------------------

## ↳ STRUCTURAL MODULE SUSPENSION, CEILING, WALL

White Black Silver Gloss anodised



		Code
Length	Weight	
1184 mm	2,30 kg	<b>M2050. 20/10/90</b>
2368 mm	4,60 kg	<b>M2051. 20/10/90</b>
3552 mm	6,90 kg	<b>M2063. 20/10/90</b>
4736 mm	9,20 kg	<b>M1995. 20/10/90</b>

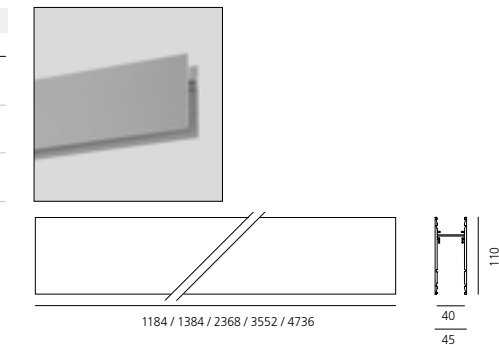

Accessories	Code
<p>90° angle To mechanically connect two recessed modules on one same plane. 0.30 kg.</p>	<b>M1968. 20/10</b> 90 60

		Code										
<p>Steel suspension cable with quick adjustment Length 2 meters</p>		<b>M189100</b>										
<table border="1"> <thead> <tr> <th>Length of a single module</th> <th>no. pieces required for each module</th> </tr> </thead> <tbody> <tr> <td>1184 mm</td> <td>2</td> </tr> <tr> <td>2368 mm</td> <td>2</td> </tr> <tr> <td>3552mm</td> <td>2</td> </tr> <tr> <td>4736mm</td> <td>3</td> </tr> </tbody> </table>	Length of a single module	no. pieces required for each module	1184 mm	2	2368 mm	2	3552mm	2	4736mm	3		Please check on Artemide.com for continuous system installations with 2+ connected modules.
Length of a single module	no. pieces required for each module											
1184 mm	2											
2368 mm	2											
3552mm	2											
4736mm	3											

<p>90° angle To mechanically connect of 2 modules on perpendicular plans. Includes through-wire extensions. 0.60 kg.</p>	<b>M1967. 20/10</b> 90 60
--	---------------------------------

<p>Suspension kit with power supply. Includes 1 single steel suspension cable + 1 power supply cable Length 2 meters</p>		
--	--	--

<p>MV (5x1,5mm2+2x0,5mm2) To power white LED plates and accent modules.</p>		<b>M189300</b>
---	--	----------------

<p>Bracket for fixing to wall/ceiling (1 piece)</p>		<b>M199400</b>
---	--	----------------

<p>Wall bracket To mechanically connect a wall-mounted module.</p>	<b>M199300</b>	
--	----------------	--

<table border="1"> <thead> <tr> <th>Length of a single module</th> <th>no. pieces required for each module</th> </tr> </thead> <tbody> <tr> <td>1184 mm</td> <td>2</td> </tr> <tr> <td>2368 mm</td> <td>2</td> </tr> <tr> <td>3552mm</td> <td>3</td> </tr> <tr> <td>4736mm</td> <td>4</td> </tr> </tbody> </table>	Length of a single module	no. pieces required for each module	1184 mm	2	2368 mm	2	3552mm	3	4736mm	4		Applicable also for system installations.
Length of a single module	no. pieces required for each module											
1184 mm	2											
2368 mm	2											
3552mm	3											
4736mm	4											

<p>End caps (set of 2)</p>	<b>M1888. 20/10</b> 90 60	
----------------------------	---------------------------------	--

<p>Linear connector</p>	<b>M189000</b>	
-------------------------	----------------	--

## WIRED GEAR PLATES SHARPING LED

White  
20

Black  
10

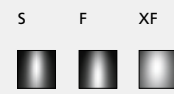

MV integrated through-cable.  
\*Occupies 1 DALI address  
\*\*Occupies 2 DALI addresses  
Protection screen for indirect cabled LED plate included.

IP20  
MacAdam 2SDC  
Life L70 (12K)> 72000h  
CRI >90

### Direct emission

Length	Optic	W	Beam	Flux	CCT	DALI* Code
1184 mm	2x4 optics	25 W	F 20°	1648 lm	3000 K	<b>AE00000</b>
			F 36°	1764 lm	4000 K	<b>AE02000</b>
	3x4 optics	38 W	F 20°	1542 lm	3000 K	<b>AE00100</b>
			F 36°	1651 lm	4000 K	<b>AE02100</b>
			XF 52°	1597 lm	3000 K	<b>AE00200</b>
			XF 52°	1709 lm	4000 K	<b>AE02200</b>
2368 mm	4x4 optics	50 W	F 20°	2473 lm	3000 K	<b>AE10000</b>
			F 36°	2646 lm	4000 K	<b>AE12000</b>
	6x4 optics	80 W	F 20°	2314 lm	3000 K	<b>AE10100</b>
			F 36°	2476 lm	4000 K	<b>AE12100</b>
			XF 52°	2396 lm	3000 K	<b>AE10200</b>
			XF 52°	2564 lm	4000 K	<b>AE12200</b>
2368 mm	4x4 optics	50 W	F 20°	3297 lm	3000 K	<b>AE20000</b>
			F 36°	3528 lm	4000 K	<b>AE22000</b>
	6x4 optics	80 W	F 20°	3085 lm	3000 K	<b>AE20100</b>
			F 36°	3301 lm	4000 K	<b>AE22100</b>
			XF 52°	3195 lm	3000 K	<b>AE20200</b>
			XF 52°	3419 lm	4000 K	<b>AE22200</b>
2368 mm	4x4 optics	50 W	F 20°	4945 lm	3000 K	<b>AE30000</b>
			F 36°	5292 lm	4000 K	<b>AE32000</b>
	6x4 optics	80 W	F 20°	4627 lm	3000 K	<b>AE30100</b>
			F 36°	4952 lm	4000 K	<b>AE32100</b>
			XF 52°	4792 lm	3000 K	<b>AE30200</b>
			XF 52°	5128 lm	4000 K	<b>AE32200</b>

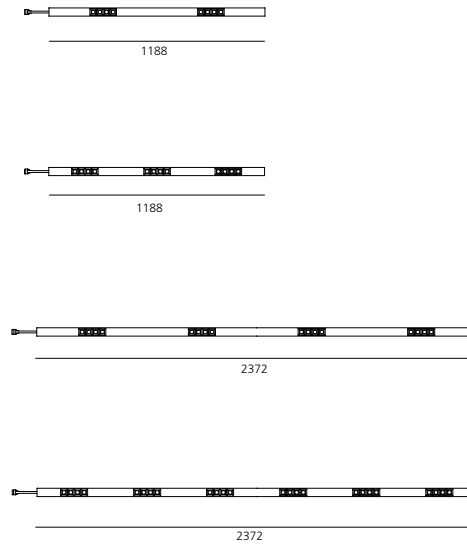

### Direct emission + indirect

Length	Optic	W	Beam	Flux	CCT	DALI** Code
1184 mm	2x4 optics	53 W	F 20°	4124 lm	3000 K	<b>AE05000</b>
			F 36°	4356 lm	4000 K	<b>AE07000</b>
	3x4 optics	64 W	F 20°	4018 lm	3000 K	<b>AE05100</b>
			F 36°	4243 lm	4000 K	<b>AE07100</b>
			XF 52°	4073 lm	3000 K	<b>AE05200</b>
			XF 52°	4301 lm	4000 K	<b>AE07200</b>
2368 mm	4x4 optics	104 W	F 20°	4948 lm	3000 K	<b>AE15000</b>
			F 36°	5238 lm	4000 K	<b>AE17000</b>
	6x4 optics	134 W	F 20°	4789 lm	3000 K	<b>AE15100</b>
			F 36°	5068 lm	4000 K	<b>AE17100</b>
			XF 52°	4871 lm	3000 K	<b>AE15200</b>
			XF 52°	5156 lm	4000 K	<b>AE17200</b>
2368 mm	4x4 optics	104 W	F 20°	8248 lm	3000 K	<b>AE25000</b>
			F 36°	8712 lm	4000 K	<b>AE27000</b>
	6x4 optics	134 W	F 20°	8036 lm	3000 K	<b>AE25100</b>
			F 36°	8485 lm	4000 K	<b>AE27100</b>
			XF 52°	8146 lm	3000 K	<b>AE25200</b>
			XF 52°	8603 lm	4000 K	<b>AE27200</b>
2368 mm	4x4 optics	104 W	F 20°	9896 lm	3000 K	<b>AE35000</b>
			F 36°	10476 lm	4000 K	<b>AE37000</b>
	6x4 optics	134 W	F 20°	9578 lm	3000 K	<b>AE35100</b>
			F 36°	10136 lm	4000 K	<b>AE37100</b>
			XF 52°	9743 lm	3000 K	<b>AE35200</b>
			XF 52°	10312 lm	4000 K	<b>AE37200</b>

### Screen

Length	Optic	Code
1184 mm	2x4 optics	<b>AE400.</b> 01/04
2368 mm	3x4 optics	<b>AE410.</b> 01/04
	4x4 optics	<b>AE420.</b> 01/04
	6x4 optics	<b>AE430.</b> 01/04
Angle 45°		<b>AE440.</b> 01/04



↪ ACCESSORIES

**Power supply/light management system**



Electronic power supply  
IP67. Input voltage range:  
90-264VAC / 47-63 VDC.  
Output voltage: 48 VDC. Protection against  
overcurrent, overvoltage, short-circuit and  
overtemperature, with automatic restart.

**100 W**  
For voltage up to a total 90 W.  
220x68x38 mm.

**240 W**  
For voltage up to a total 225 W.  
244x68x39 mm.

**320 W**  
For voltage up to a total 300 W.  
252x90x44 mm.

**Code**

**M075000**

**M075100**

**M076100**

**Closure screens for 90° angles**



Junction to be fitted  
to the module on the same plane  
Compatible with the junction  
for the same plane.  
For continuity between LED diffused  
emission modules.  
For continuity between LED emission  
modules and spot modules.  
For continuity between wall-washer LED  
emission modules.

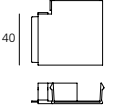

**Code**

**M198100**

**M198000**



2-plane joint  
To be clipped to the module.  
Compatible with connectors for  
2 modules on perpendicular planes.  
For continuity between LED diffused  
emission modules.  
For continuity between LED emission  
modules and spot modules.  
For continuity between wall-washer LED  
emission modules.

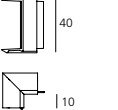

**M198500**

**M198400**

**Electrical components**



Supplementary through-wiring (optional).  
To be used in mixed configuration with MV  
pre-cabled gear trays.

MV 1184 mm  
MV 2368 mm

**Code**

**M198700**

**M198900**



Supply Kit  
Allows for connection of the mains  
to the first pre-wired gear plate  
of the initial module. To be used only with  
recessed and surface installation.  
MV (7xmax 1,5 mm<sup>2</sup>)  
To power white LED plates and accent  
modules.

**M073240**



Steekcase headquarters and showroom Madrid, Arch.: John Small, architect and director of design for Steekcase International, Photo: Juanjo Fernandez

# Smart Office

Carlotta de Bevilacqua

↳ 2016





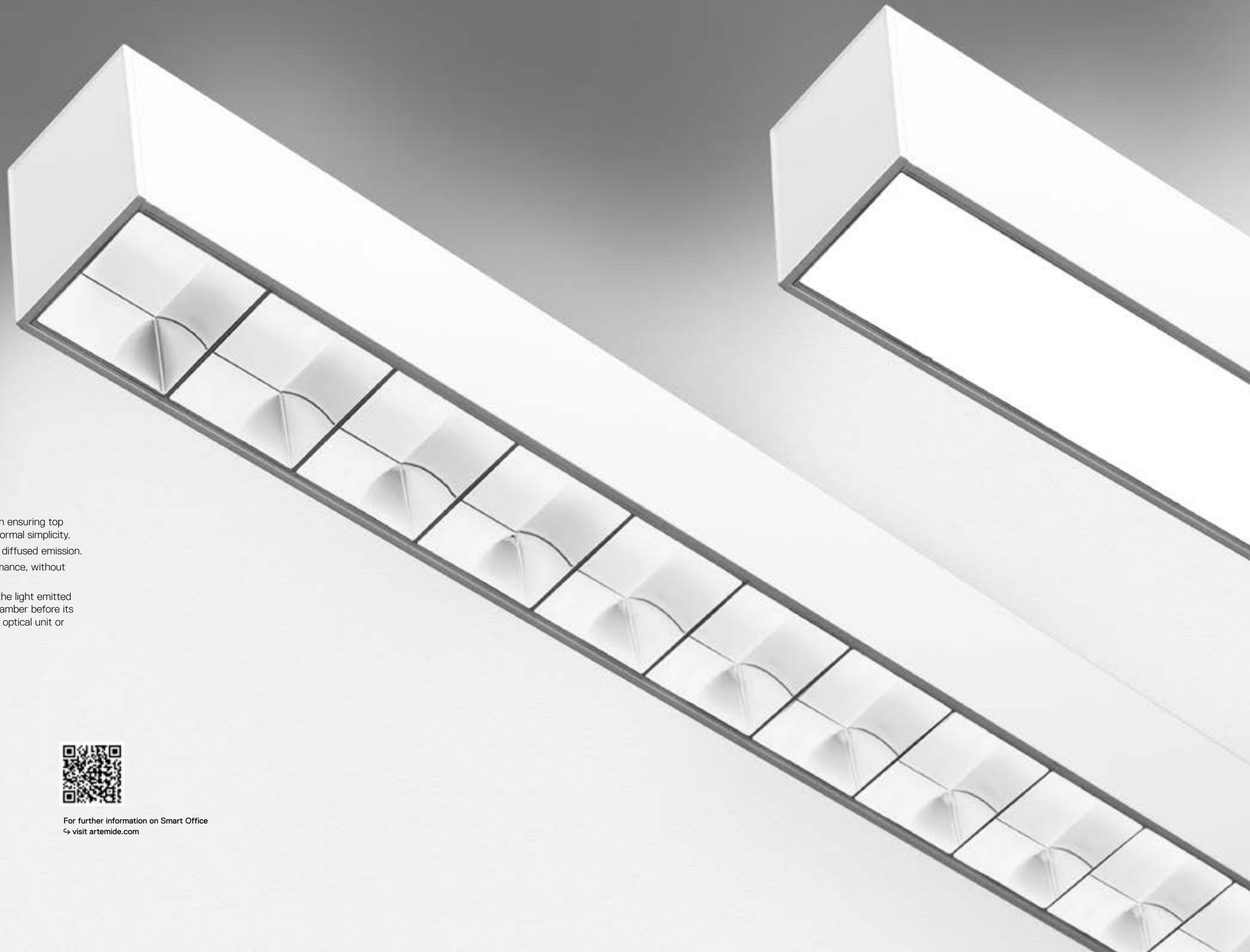

Dedicated office suspension ensuring top performance with utmost formal simplicity.  
Available with controlled or diffused emission.  
Highly uniform light performance, without multiple shadows or spots.  
Innovative optical system: the light emitted is controlled by a mixing chamber before its emission through a lamellar optical unit or diffuser.  
Two lengths available.



**Artemide  
App**  
↪ on request



For further information on Smart Office  
↪ visit [artemide.com](http://artemide.com)

↪ SMART OFFICE - DIFFUSED EMISSION

White 01	Black 04	XF	Uses 1 DALI address	MacAdam 3SDCM Life L70 (6K) 50000h CRI=90 UGR <19	IP20
-------------	-------------	----	---------------------	--	------

Direct emission + indirect					
Length	W	CRI	Weight	Flux	CCT
1129 mm	37 W	=80	16,00 kg	3619 lm	3000 K
				3814 lm	4000 K

Undimmable	
Code	
AG200. 01/04	
AG201. 01/04	

Dimmable DALI	
Code	
AG225. 01/04	
AG226. 01/04	

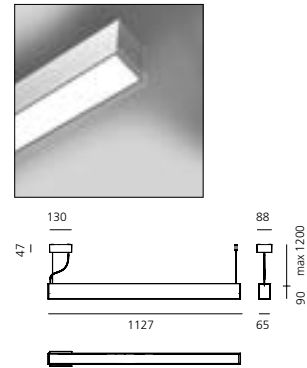

Direct emission + indirect					
Length	W	CRI	Weight	Flux	CCT
2249 mm	81 W	=80	16,00 kg	7239 lm	3000 K
				7628 lm	4000 K

Undimmable	
Code	
AG250. 01/04	
AG251. 01/04	

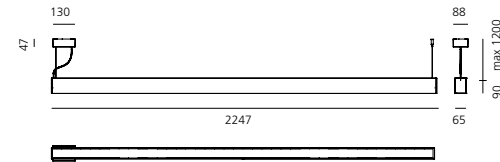

Direct emission + indirect					
Length	W	CRI	Weight	Flux	CCT
2249 mm	76 W	=80	16,00 kg	7239 lm	3000 K
				7628 lm	4000 K

Dimmable DALI	
Code	
AG275. 01/04	
AG276. 01/04	

TUNABLE WHITE



Direct emission + indirect			
Length	W	Weight	CCT
1129 mm	37 W	16,00 kg	2700K - 5700K

Dimmable DALI	
Code	
AG290. 01/04	

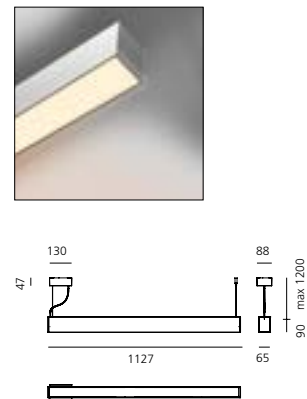

↪ SMART OFFICE - CONTROLLED EMISSION

White 01	Black 04	XF	Uses 1 DALI address	MacAdam 3SDCM Life L70 (6K) 50000h CRI=90 UGR <19	IP20
-------------	-------------	----	---------------------	--	------

Direct emission + indirect					
Length	W	CRI	Weight	Flux	CCT
1129 mm	37 W	=80	16,00 kg	4331 lm	3000 K
				4564 lm	4000 K

Undimmable	
Code	
AG000. 01/04	
AG001. 01/04	

Dimmable DALI	
Code	
AG025. 01/04	
AG026. 01/04	

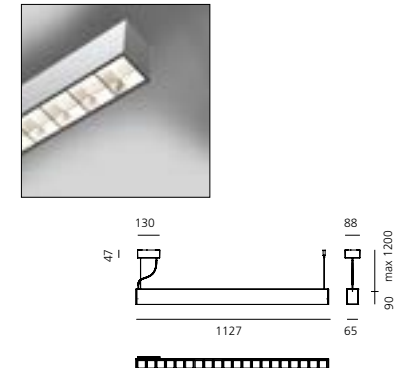

Direct emission + indirect					
Length	W	CRI	Weight	Flux	CCT
2249 mm	81 W	=80	16,00 kg	8662 lm	3000 K
				9128 lm	4000 K

Undimmable	
Code	
AG050. 01/04	
AG051. 01/04	

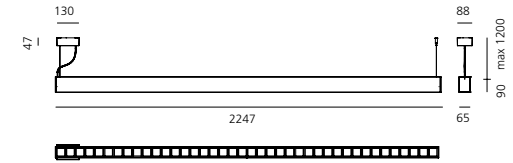

Direct emission + indirect					
Length	W	CRI	Weight	Flux	CCT
2249 mm	76 W	=80	16,00 kg	8662 lm	3000 K
				9128 lm	4000 K

Dimmable DALI	
Code	
AG075. 01/04	
AG076. 01/04	

TUNABLE WHITE



Direct emission + indirect			
Length	W	Weight	CCT
1129 mm	37 W	16,00 kg	2700K - 5700K

Dimmable DALI	
Code	
AG090. 01/04	

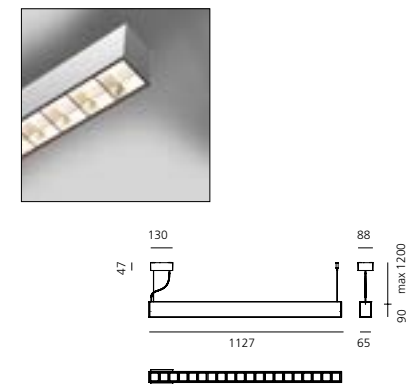



# Series Y

Gensler  
↳ 2017



Artemide  
App  
↳ on request



For further information on Series Y  
↳ visit [artemide.com](http://artemide.com)





# Series Y optics

Direct emission



Diffused emission



35W  
2940 lm  
Undimmable

Controlled emission



35W  
2559 lm  
Undimmable

Direct + indirect emission



Diffused + batwing emission



55W  
4742 lm  
Dimmable DALI separately

Controlled + Batwing emission



55W  
4361 lm  
Dimmable DALI separately



# Series Y

Batwing indirect emission



Maximum flexibility of composition

Horizontal rotation modules respecting a minimum of 75°

Controlled emission

Diffused emission

Free vertical tilt up to 30° upwards or 30° downwards

# Horizontal and vertical freedom to play with

## → ROTATION ON HORIZONTAL PLANE

During the installation it is possible to freely choose the position of each single module, respecting a minimum angle between two modules of 75°.

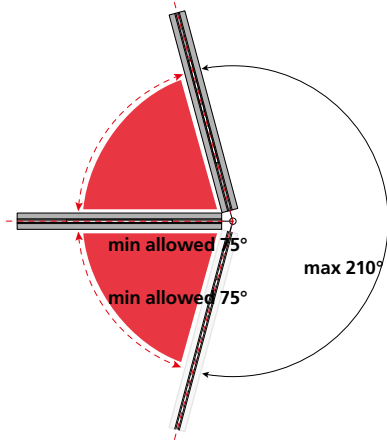

## → TILT ON VERTICAL PLANE

Each module can be easily tilted (upward or downward) up to 30° from the horizontal plane.

This two movements (rotation and tilting) can be mixed up in infinite possibilities to best adapt to space requirements.

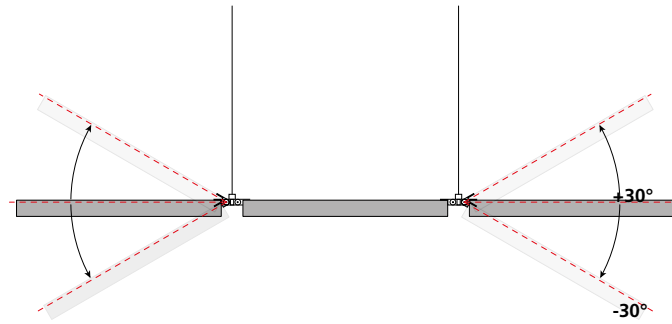

## → POSSIBLE MULTIPLE CONFIGURATIONS UP TO 4 MODULES

### POWERED JOINT AND SUSPENSION CABLE



X 2 MODULES



X 3 MODULES

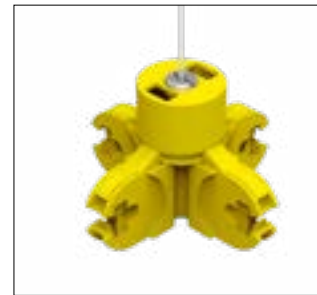

X 4 MODULES

### MECHANICAL JOINT AND SUSPENSION CABLE



X 2 MODULES



X 3 MODULES



X 4 MODULES

# Series Y joints

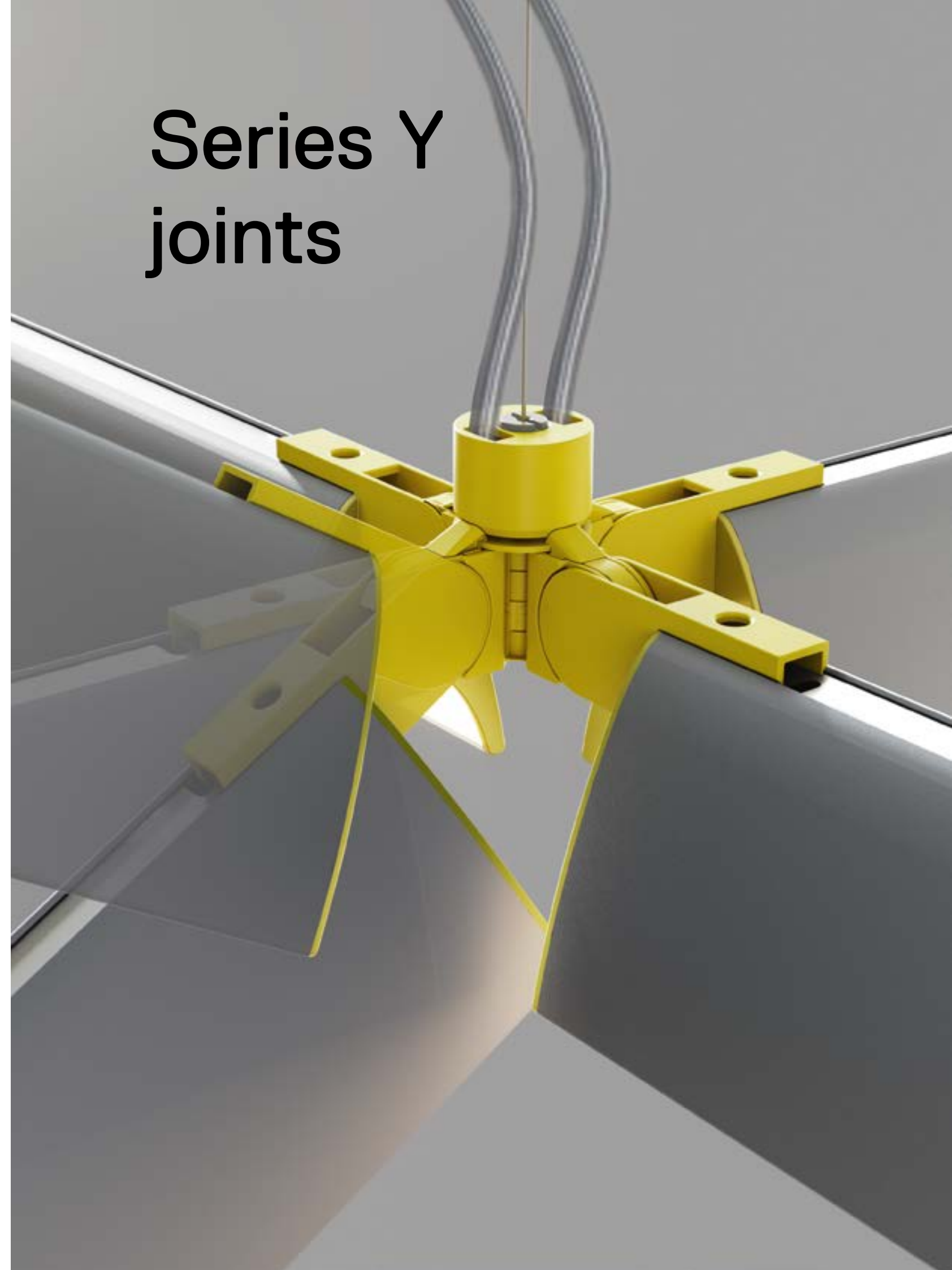



# Series Y linear configuration

END CAP

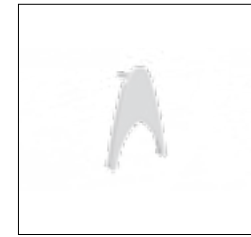

TERMINAL SUSPENSION KIT



INTERMEDIATE SUSPENSION KIT

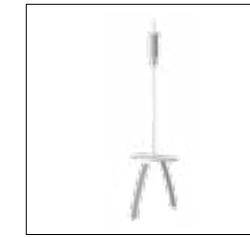

CEILING ROSE



○ Small 416x99x65 mm  
x1, x2, x3, x4 modules  
Undimmable  
x1, x2 modules  
Dimmable DALI

○ Large 416x139x65 mm  
x3, x4 modules  
Dimmable DALI

→ 1 MODULE

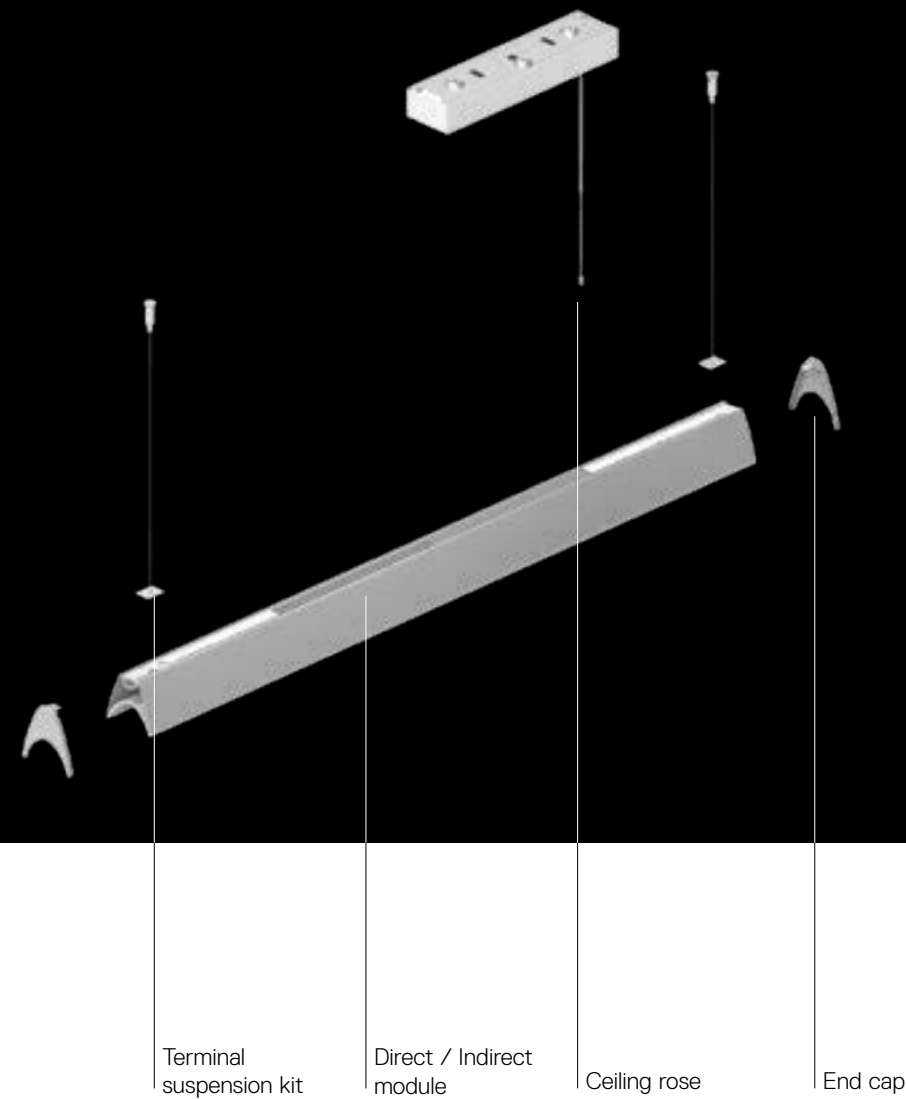

→ MORE THAN 2 MODULES

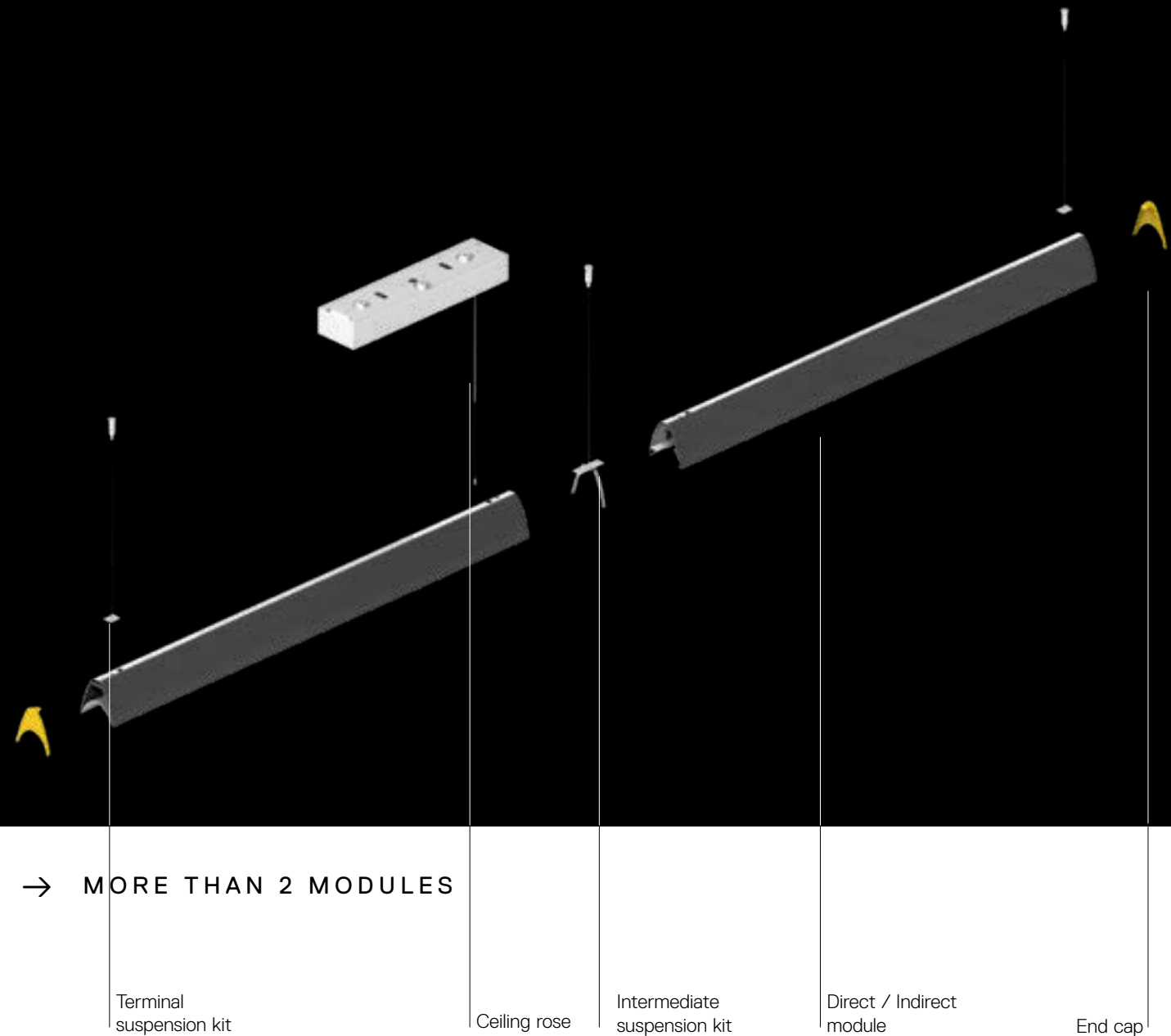

# Series Y star configuration

JOINT POWERED

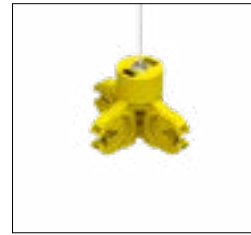

END CAP

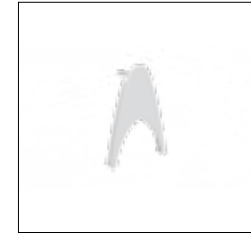

JOINT END CAP



TERMINAL  
SUSPENSION KIT



CEILING ROSE

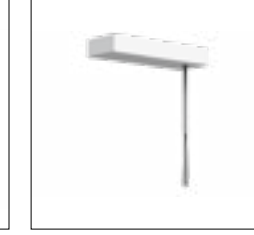

○ Small 416x99x65 mm  
x1, x2, x3, x4 modules  
Undimmable  
x1, x2 modules  
Dimmable DALI

○ Large 416x139x65 mm  
x3, x4 modules  
Dimmable DALI

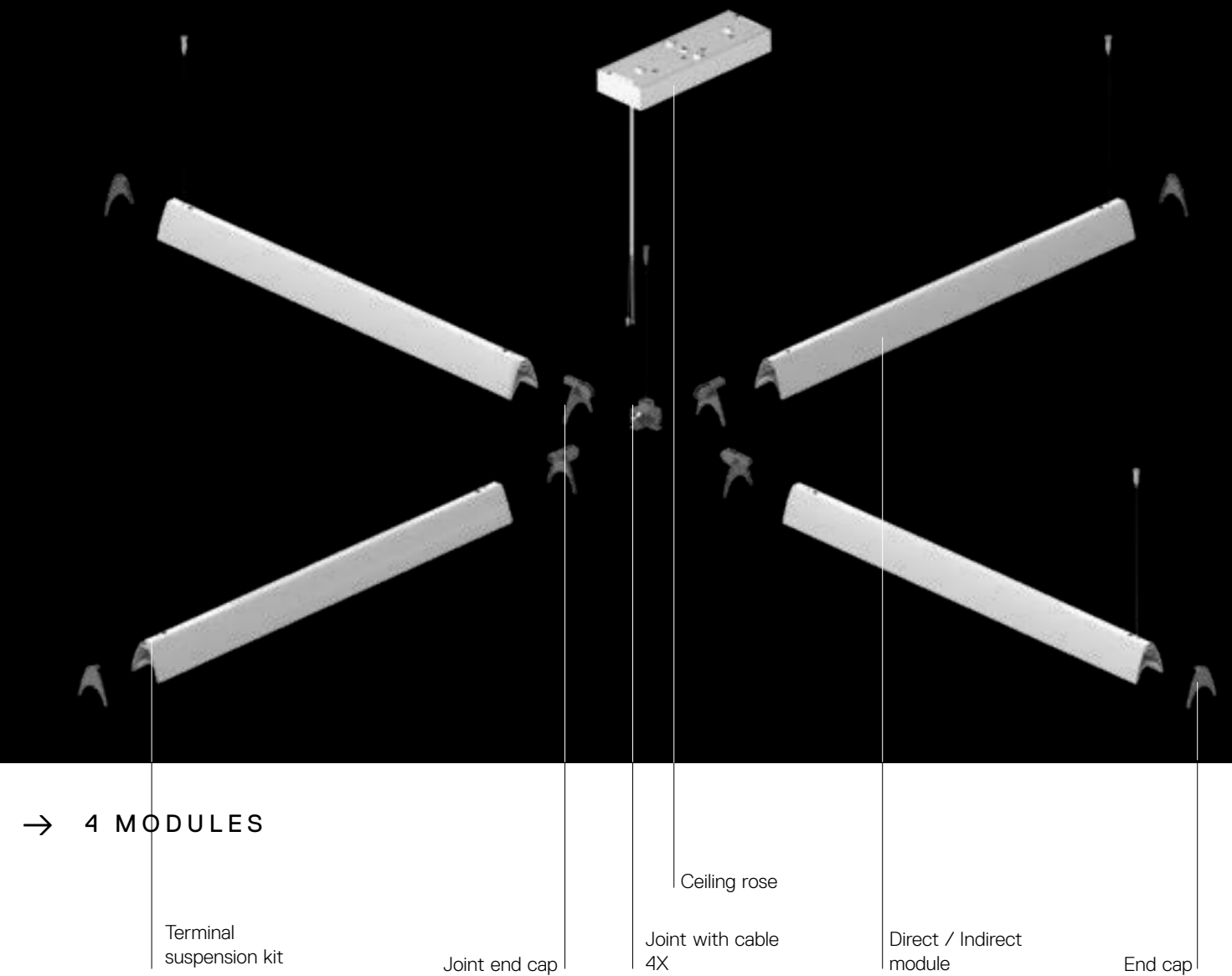
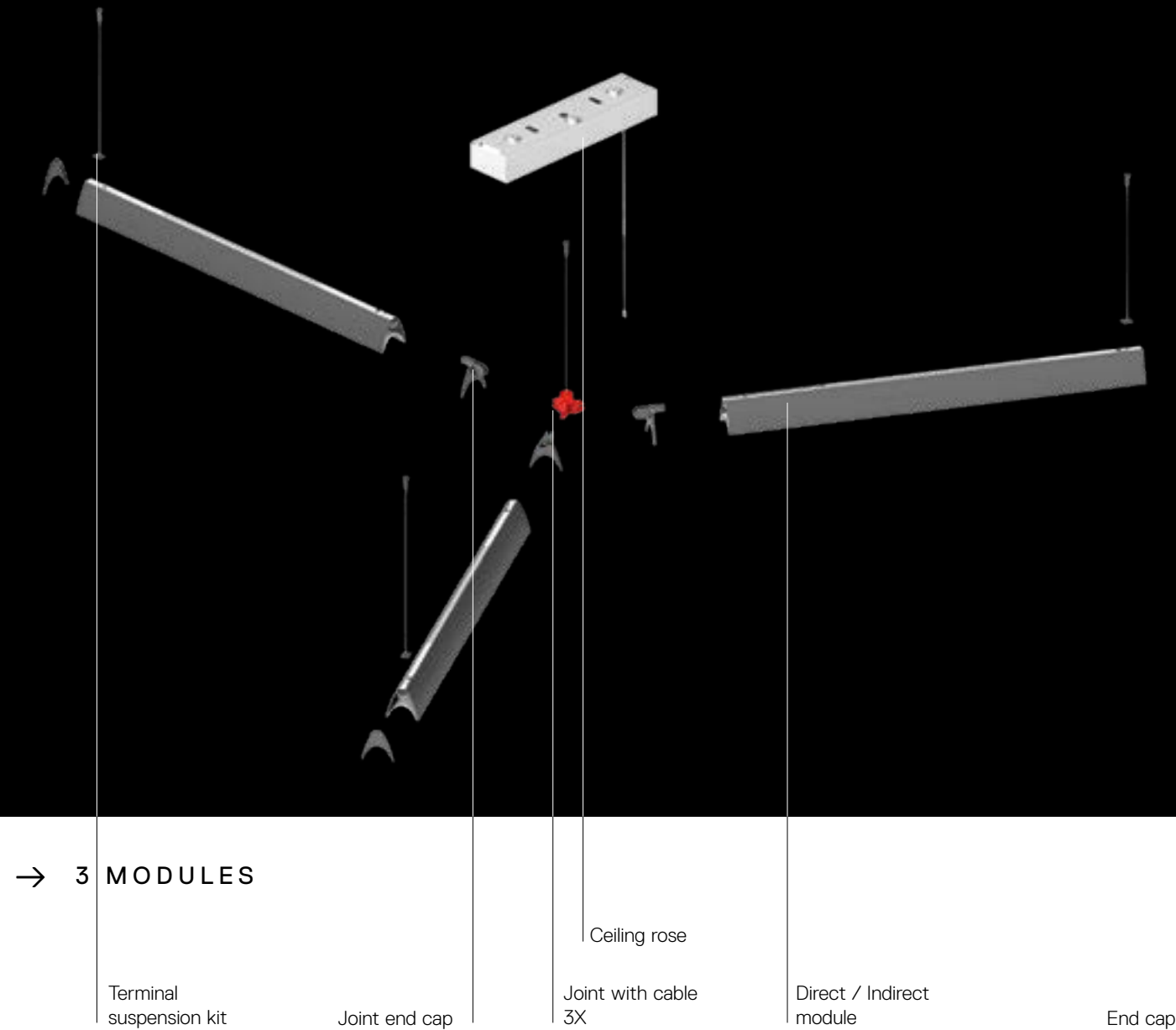

# Series Y mixed configuration

MECHANICAL JOINT



JOINT WITH CABLE



END CAP

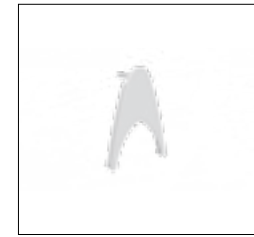

JOINT END CAP



TERMINAL  
SUSPENSION KIT



CEILING ROSE



○ Small 416x99x65 mm  
x1, x2, x3, x4 modules  
Undimmable  
x1, x2 modules  
Dimmable DALI

○ Large 416x139x65 mm  
x3, x4 modules  
Dimmable DALI



→ 3+2 MODULES

Terminal  
suspension kit

Ceiling rose

Intermediate  
suspension kit

Direct / Indirect  
module

Joint end cap

Mechanical joint  
2X

Joint with cable  
2X

End cap

↪ SERIES Y - DIRECT EMISSION UNDIMMABLE

White 01 Black 04 Silver 05

MacAdam 3SDCM  
Life L70 (6K) 50000h  
CRI = 90

IP20

DIFFUSED EMISSION

Length	W	CRI	Flux	CCT	Undimmable Code
1120mm	35 W	90	2940 lm	3000K	<b>AY000.</b> 01/04/05
			3095 lm	4000K	<b>AY005.</b> 01/04/05

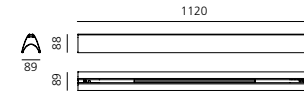

CONTROLLED EMISSION

Length	W	Flux	CCT	Undimmable Code
1120mm	35 W	2559 lm	3000K	<b>AY010.</b> 01/04/05
		2694 lm	4000K	<b>AY015.</b> 01/04/05

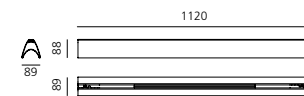

Ceiling rose	Undimmable Code
Rose x 1 module	<b>AY80101</b>
Rose x 2 modules	<b>AY80201</b>
Rose x 3 modules - linear configuration	<b>AY80301</b>
Rose x 3 modules - star configuration	<b>AY80401</b>
Rose x 4 modules - linear configuration	<b>AY80501</b>
Rose x 4 modules - star configuration	<b>AY80601</b>



**Small Undimmable rose**  
Ceiling rose suitable for all undimmable modules configurations.

LINEAR CONFIGURATION

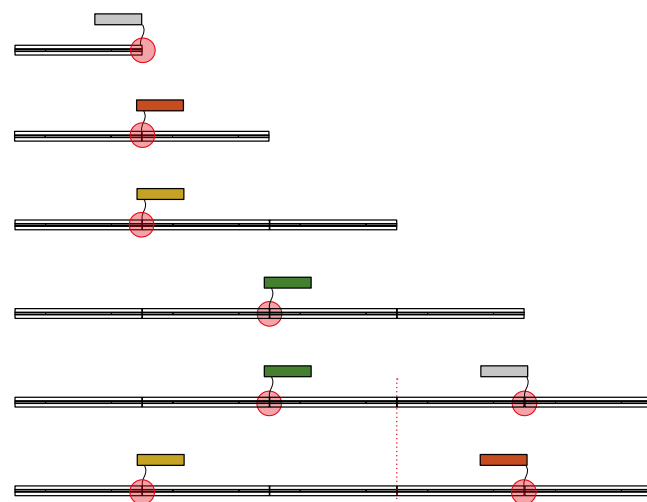

No electrical connection between modules

STAR CONFIGURATION

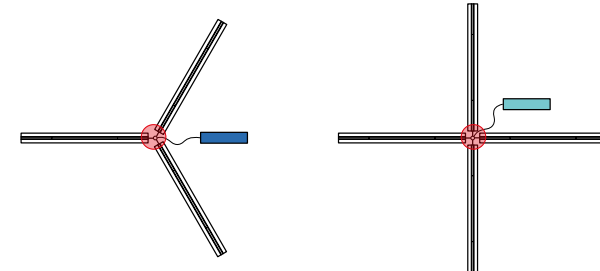

MIXED CONFIGURATION

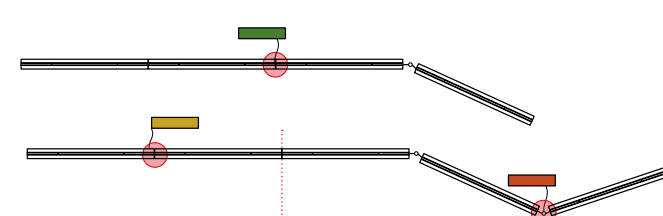

No electrical connection between modules

↪ SERIES Y - DIRECT + INDIRECT EMISSION DIMMABLE

White 01 Black 04 Silver 05

MacAdam 3SDCM  
Life L70 (6K) 50000h  
CRI = 90

IP20

DIFFUSED DIRECT EMISSION + BATWING INDIRECT EMISSION

Length	W	Flux	CCT	Dimmable DALI Code
1120mm	35 W direct 20 W indirect	2940 lm direct 1802 lm indirect	3000K	<b>AY050.</b> 01/04/05
		3095 lm direct 1897 lm indirect	4000K	<b>AY055.</b> 01/04/05

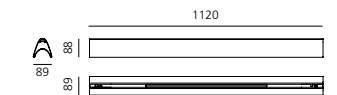

CONTROLLED DIRECT EMISSION + BATWING INDIRECT EMISSION

Length	W	Flux	CCT	Dimmable DALI Code
1120mm	35 W direct 20 W indirect	2559 lm direct 1802 lm indirect	3000K	<b>AY060.</b> 01/04/05
		2694 lm direct 1897 lm indirect	4000K	<b>AY065.</b> 01/04/05

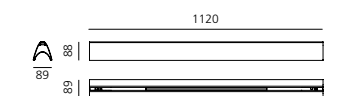

Ceiling rose	Dimmable DALI Code
Rose x 1 module	<b>AY81101</b>
Rose x 2 modules	<b>AY81201</b>
Rose x 3 modules - linear configuration	<b>AY81301</b>
Rose x 3 modules - star configuration	<b>AY81401</b>
Rose x 4 modules - linear configuration	<b>AY81501</b>
Rose x 4 modules - star configuration	<b>AY81601</b>

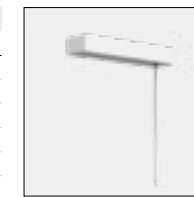

**Small Dimmable rose**  
Ceiling rose suitable for 1 or 2 dimmable modules configurations.

**Large Dimmable rose**  
Ceiling rose suitable for 3 or 4 dimmable modules configurations.

LINEAR CONFIGURATION

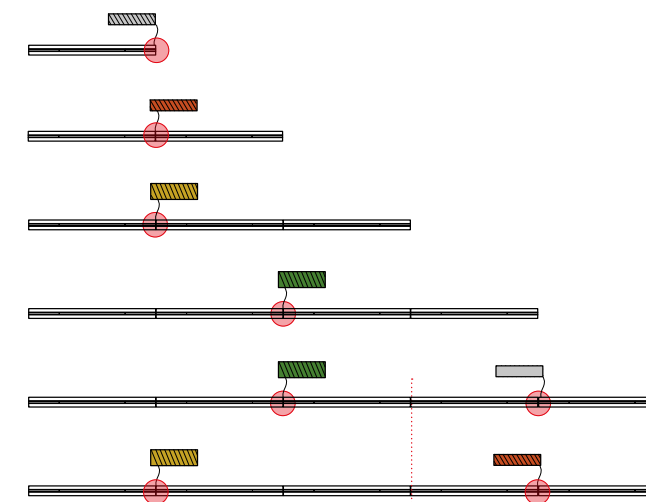

No electrical connection between modules

STAR CONFIGURATION

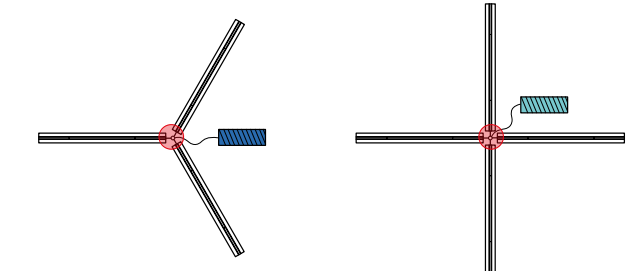

MIXED CONFIGURATION

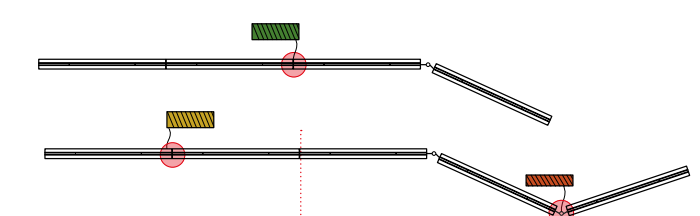



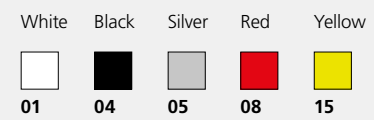

No electrical connection between modules

↪ SERIES Y - JOINT



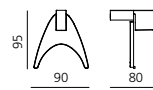

Accessories

	Code
 Terminal suspension kit	<b>AY50000</b>
 Intermediate suspension kit	<b>AY51000</b>
 End cap	<b>AY600.</b> 01/04 05/08/15
 Joint End cap	<b>AY610.</b> 01/04 05/08/15



Powered joint

	Code
 x 2 modules + suspension cable	<b>AY700.</b> 01/04 05/08/15
 x 3 modules + suspension cable	<b>AY710.</b> 01/04 05/08/15
 x 4 modules + suspension cable	<b>AY720.</b> 01/04 05/08/15

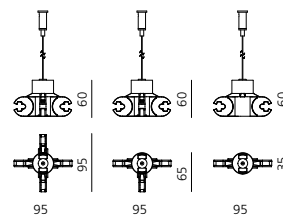

Meccanical joint

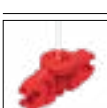
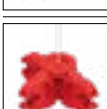
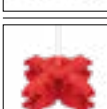
	Code
 x 2 modules + suspension cable	<b>AY730.</b> 01/04 05/08/15
 x 3 modules + suspension cable	<b>AY740.</b> 01/04 <b>AY750.</b> 05/08/15
 x 4 modules + suspension cable	<b>AY760.</b> 01/04 05/08/15

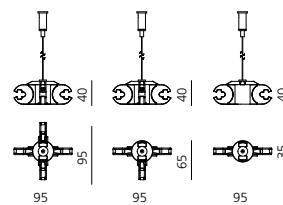



# Calipso

Neil Poulton

↪ 2017







# Calipso Linear System suspension





Calipso suspension - wall / ceiling

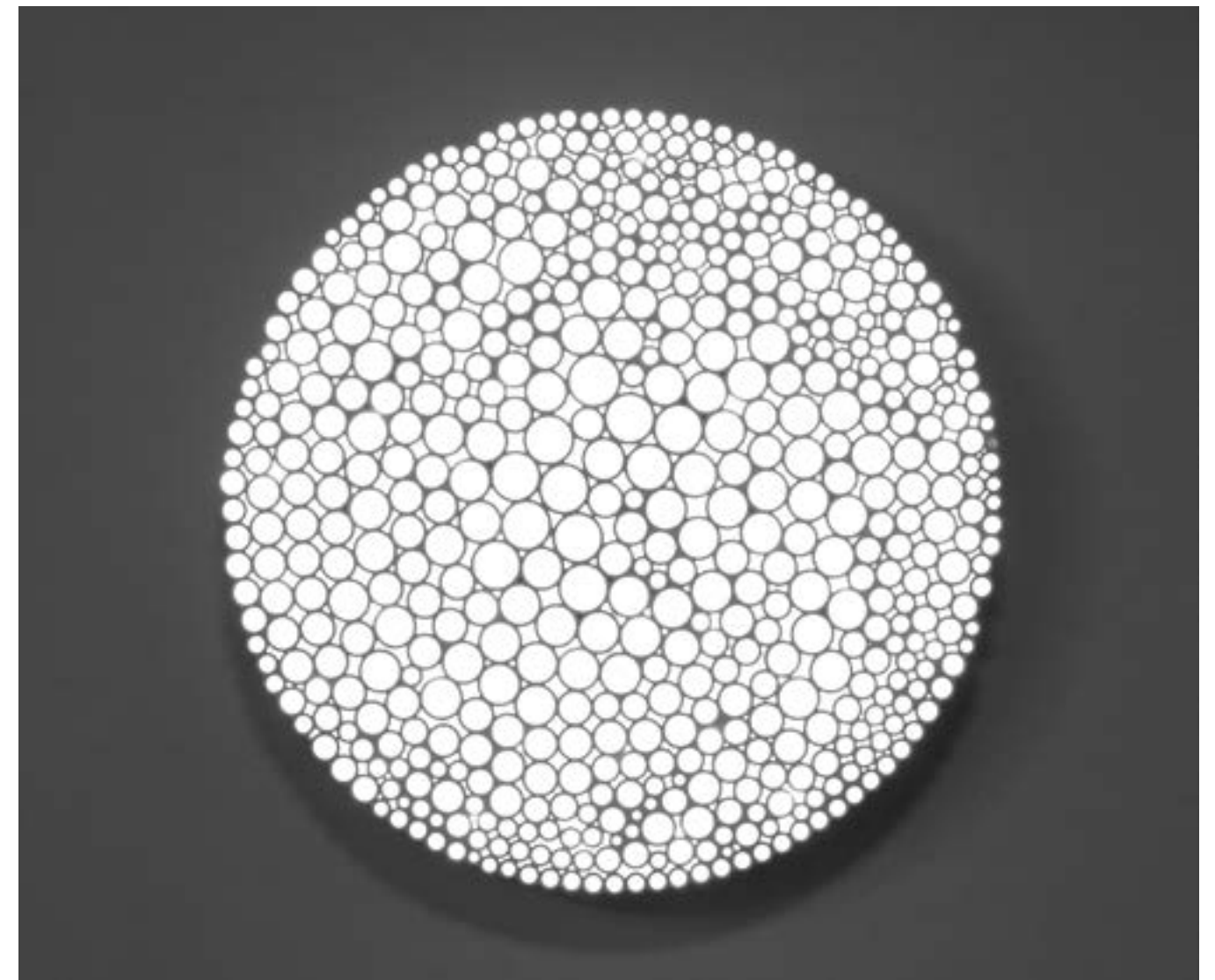

# Calipso typologies

## STAND ALONE - CEILING



LINEAR L=1200 MM



XF  
(>45°)  
46 W  
2640 lm

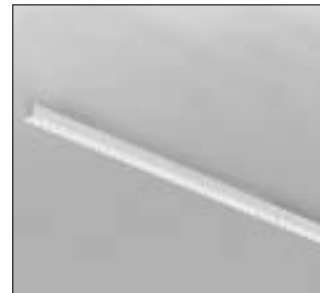

LINEAR L=1800 MM



XF  
(>45°)  
69 W  
3960 lm

## STAND ALONE - SUSPENSION



LINEAR L=1200 MM



XF  
(>45°)  
46 W  
2640 lm



LINEAR L=1800 MM



XF  
(>45°)  
69 W  
3960 lm

## WALL - CEILING

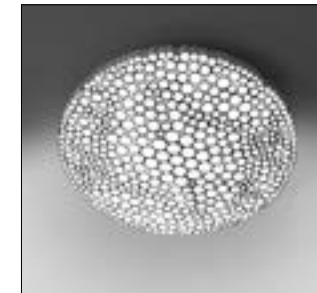

XF  
(>45°)  
55 W  
2884 lm

## SUSPENSION



XF  
(>45°)  
55 W  
2884 lm

The fractal shape of the small circles works as an optical grid and defines a comfort emission.

Round version is available in one diameter (526mm), suspension and ceiling / wall.

Linear version are available in two lengths (1200 and 1800 mm), suspension and ceiling.

System version available in three lengths (600, 1200 and 1800 mm) suspension and ceiling. Can be composed in line or with 90° right or left angles.

Materials: matt white technopolymer body and aluminum structure.



For further information on Calipso  
↪ visit [artemide.com](http://artemide.com)

## SYSTEM - SUSPENSION - CEILING



LINEAR SYSTEM L=600 MM



XF  
(>45°)  
23 W  
1320 lm



LINEAR SYSTEM L=1200 MM



XF  
(>45°)  
46 W  
2640 lm





LINEAR SYSTEM L=1800 MM



XF  
(>45°)  
69 W  
3960 lm

# ↪ CALIPSO

White 	XF 	The APP driver can not be controlled by DALI dimming system and viceversa.	MacAdam 3SDCM Life L70 (10K)>35500h CRI =90	IP20 
--	---	--	---	---

## CALIPSO WALL - CEILING

W	Beam	Flux	CCT	PUSH Code	PUSH & APP Code
55 W	XF	2884 lm	2700K 3000K	<b>0210W10A</b> <b>0210010A</b>	<b>0210W10APP</b> <b>0210010APP</b>

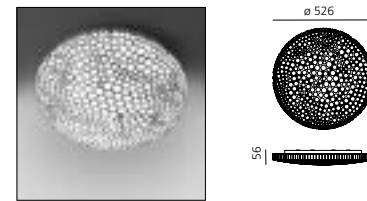

## CALIPSO SUSPENSION

W	Beam	Flux	CCT	PUSH Code	PUSH & APP Code
55 W	XF	2884 lm	2700K 3000K	<b>0213W10A</b> <b>0213010A</b>	<b>0213W10APP</b> <b>0213010APP</b>

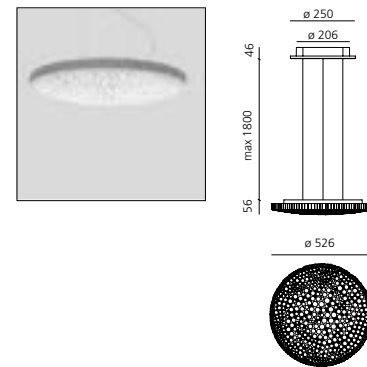

## CALIPSO LINEAR STAND ALONE CEILING

Lenght	W	Beam	Flux	CCT	PUSH/DALI Code
1210 mm	43 W	XF	2985 lm	3000K	<b>0220010A</b>
1790 mm	63 W	XF	4477 lm	3000K	<b>0221010A</b>

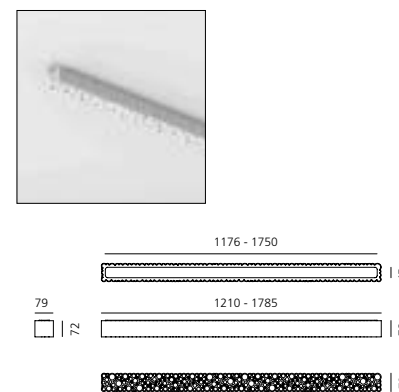

## CALIPSO LINEAR STAND ALONE SUSPENSION

Lenght	W	Beam	Flux	CCT	PUSH/DALI Code
1210 mm	43 W	XF	2985 lm	3000K	<b>0223010A</b>
1790 mm	63 W	XF	4477 lm	3000K	<b>0224010A</b>

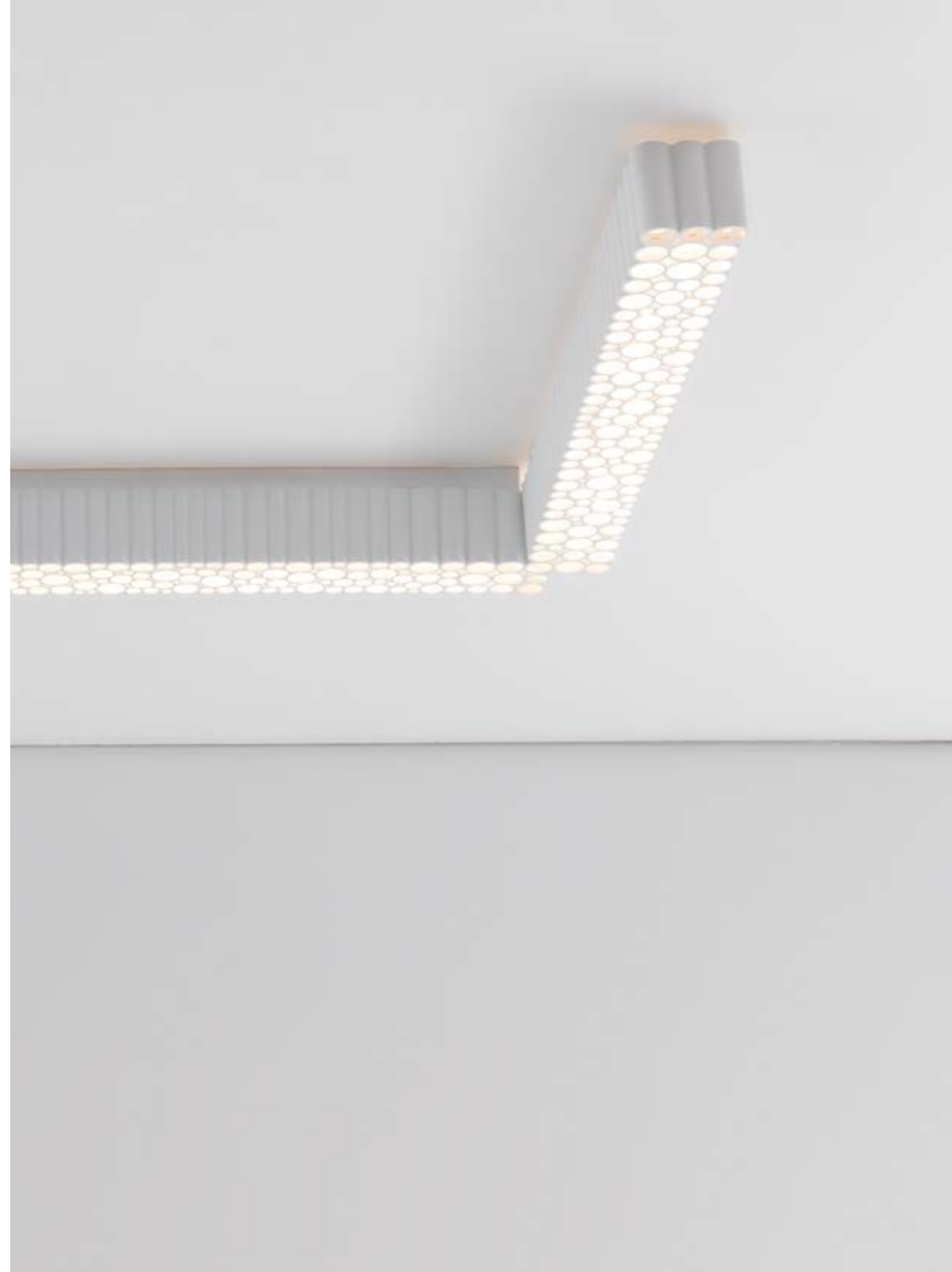
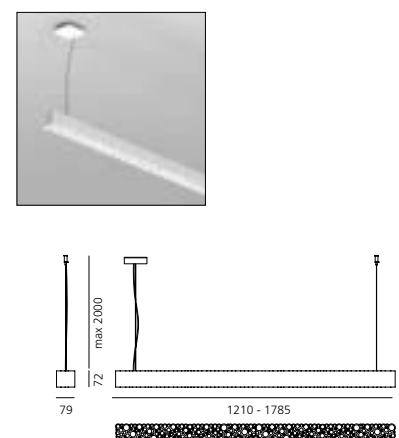

Calipso

↳ linear system

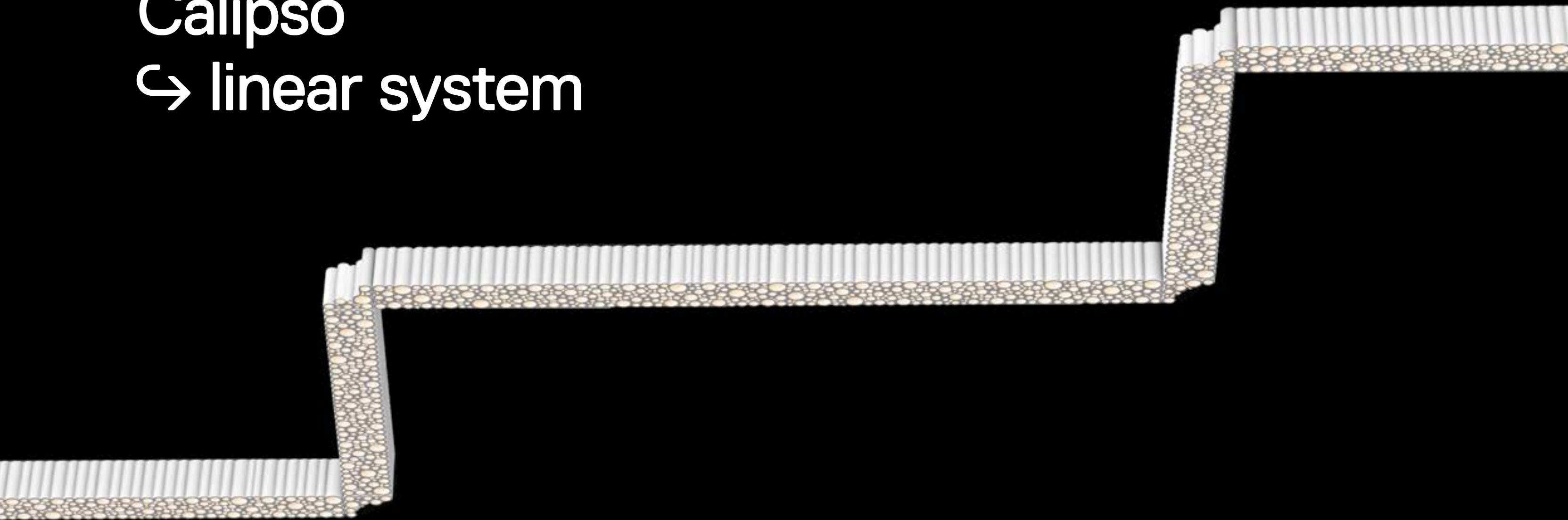

## ↪ CALIPSO LINEAR SYSTEM / CONFIGURATIONS

In APP configurations must be only one App master module others must be DALI

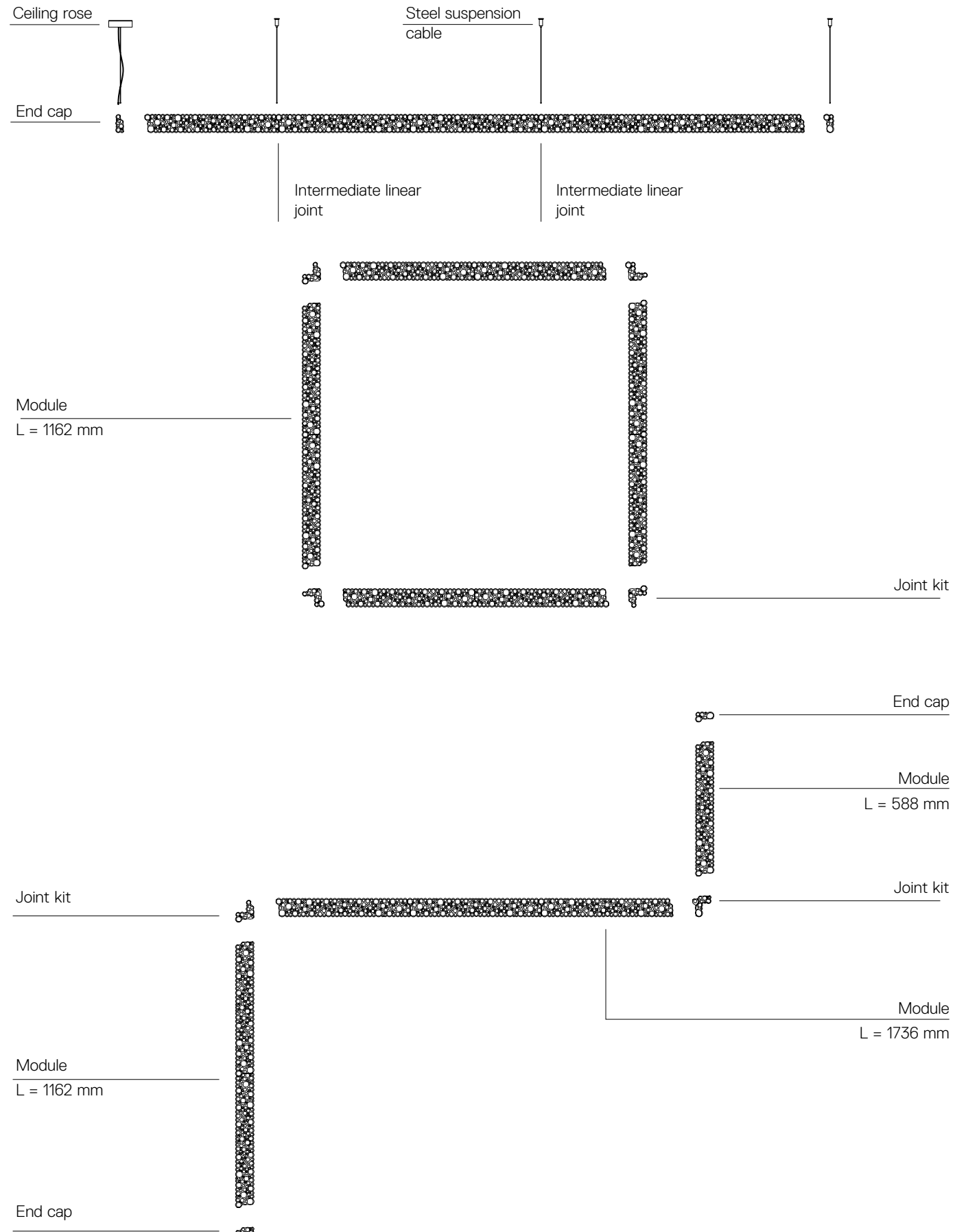

## ↪ CALIPSO LINEAR SYSTEM

White 	XF 	The APP driver can not be controlled by DALI dimming system and viceversa. In APP configurations must be only one App master module others must be DALI	MacAdam 3SDCM Life L70 (10K)=50000h CRI =90	IP20 
-----------	--------	--	---	----------

### SUSPENSION

Modules					PUSH/DALI	APP
Lenght	W	Beam	Flux	CCT	Code	Code
588 mm	22 W	XF	1492 lm	3000K	<b>2013010A</b>	
1210 mm	43 W	XF	2985 lm	3000K	<b>2014010A</b>	<b>2014010APP</b>
1785 mm	63 W	XF	4477 lm	3000K	<b>2015010A</b>	<b>2015010APP</b>

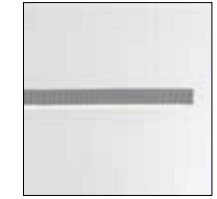

### Accessories - suspension

		Code
	End caps kit (2 pcs)	<b>2022010A</b>
	Joint 90° kit (dx/sx)	<b>2023010A</b>
	Intermediate linear joint	<b>2021010A</b>
	Connection cable To be only used when the power kit is not in the end caps	<b>2024010A</b>
	Power kit for suspension modules 1 steel suspension cable + 1 alimentation cable	<b>2020010A</b>
	Steel suspension cable Length 1,5 meters	<b>2266010A</b>

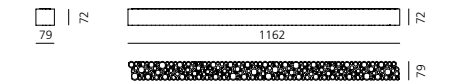

### CEILING

Modules					PUSH/DALI	APP
Lenght	W	Beam	Flux	CCT	Code	Code
588 mm	22 W	XF	1492 lm	3000K	<b>2010010A</b>	
1210 mm	43 W	XF	2985 lm	3000K	<b>2011010A</b>	<b>2011010APP</b>
1785 mm	63 W	XF	4477 lm	3000K	<b>2012010A</b>	<b>2012010APP</b>



### Accessories - ceiling

		Code
	End cap kit (2 pcs)	<b>2026010A</b>
	Joint 90° kit (dx/sx)	<b>2027010A</b>
	Intermediate linear joint	<b>2025010A</b>



# Grafa System

Wilmotte&Industries

↪ 2014



**Artemide  
App**

↪ on request



For further information on Grafa  
↪ visit [artemide.com](http://artemide.com)

Modular system with direct emission and indirect with LED high efficiency.  
Installation with suspension.  
Single mounting, in continuous line by angle (90°), free composition.  
Dimmable electronic power supply DALI.  
Materials: structure in extruded aluminum anodised matte, top screen with anti-dust polycarbonate, staples in 6 different tones.  
Quick adjustment steel suspension cables.  
Complies with EN62471, EN60598-1 and other specific standards.





# Grafa System typologies

# Grafa System driver

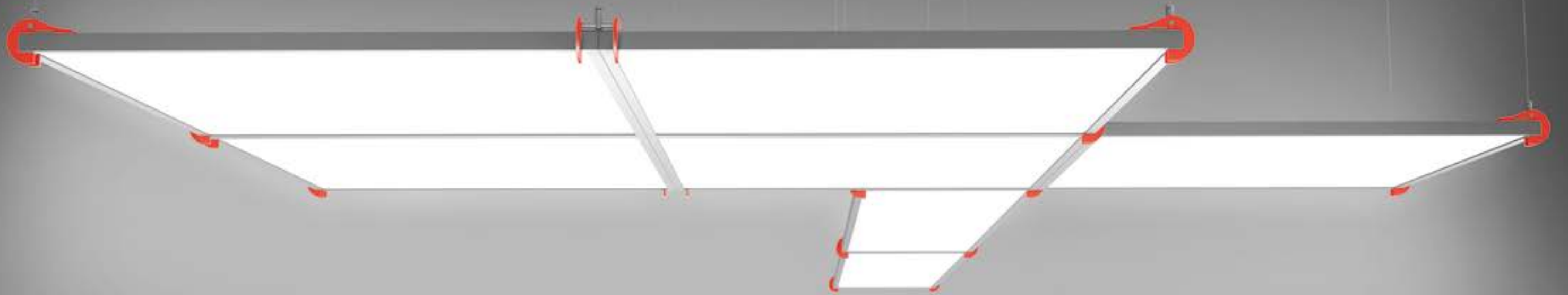

## SYSTEM MODULES

Module  
1200x300  
single



Module  
1200x300  
modular



Module  
600x600  
single



Module  
600x600  
modular linear



Module  
600x600  
modular angular

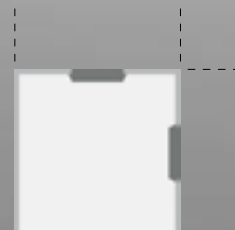

## SUSPENDED ACCESSORIES

Single Clip



Angular Brackets

Double Clip



Mixed Modules Brackets

Angular Clip



## DRIVER LINKS

Kit driver 1X - end links  
2 possible positions A-B

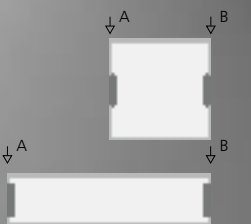

Kit driver 2X - central links  
3 possible positions A-B-C

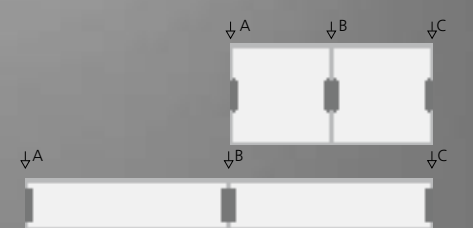

Kit 3X central links  
2 possible positions A-B

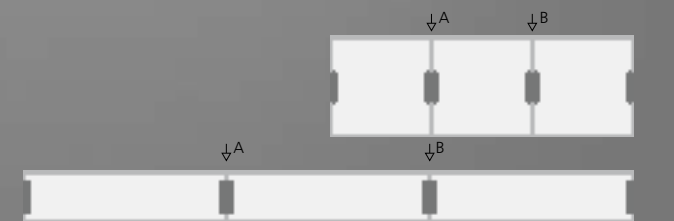

Kit 4X central links  
one possible position A

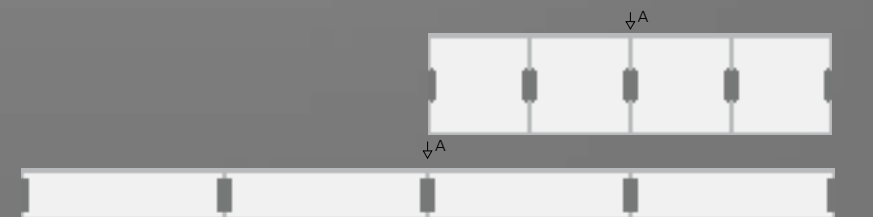

# Grafa System configuration

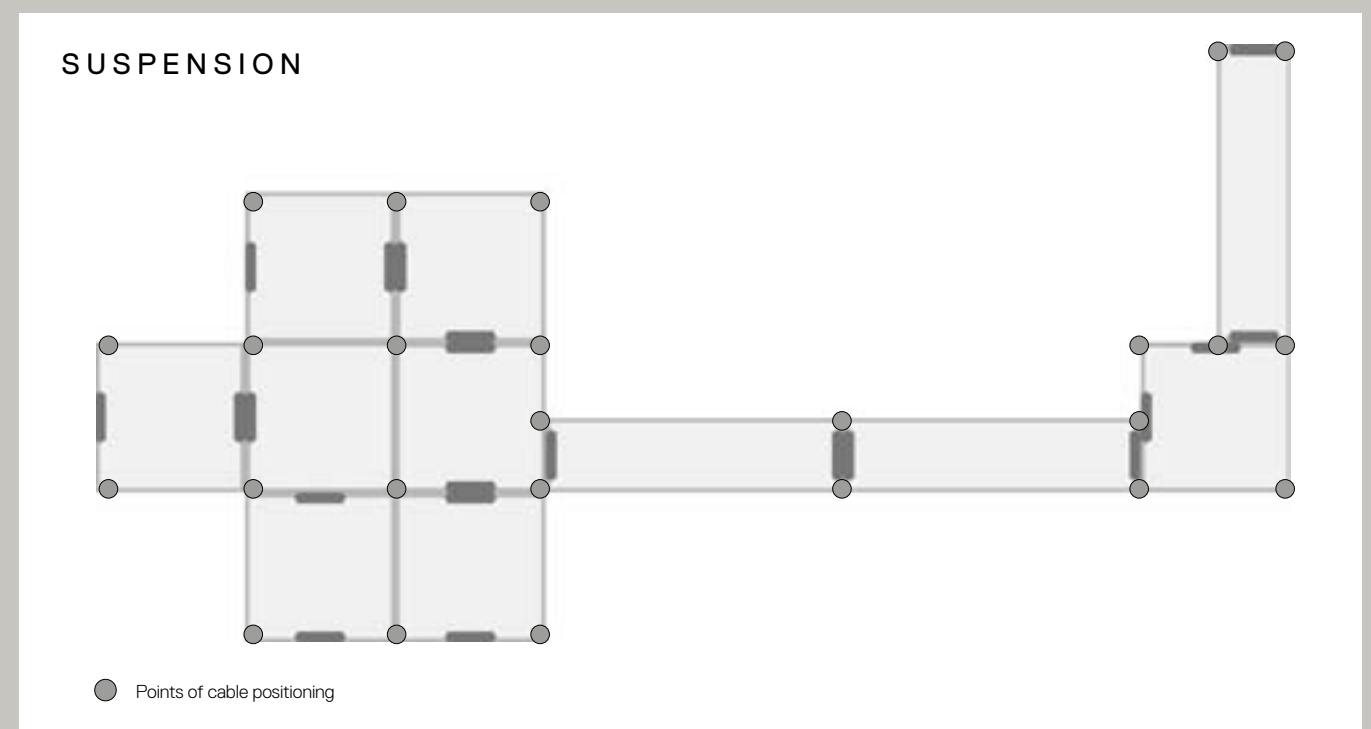
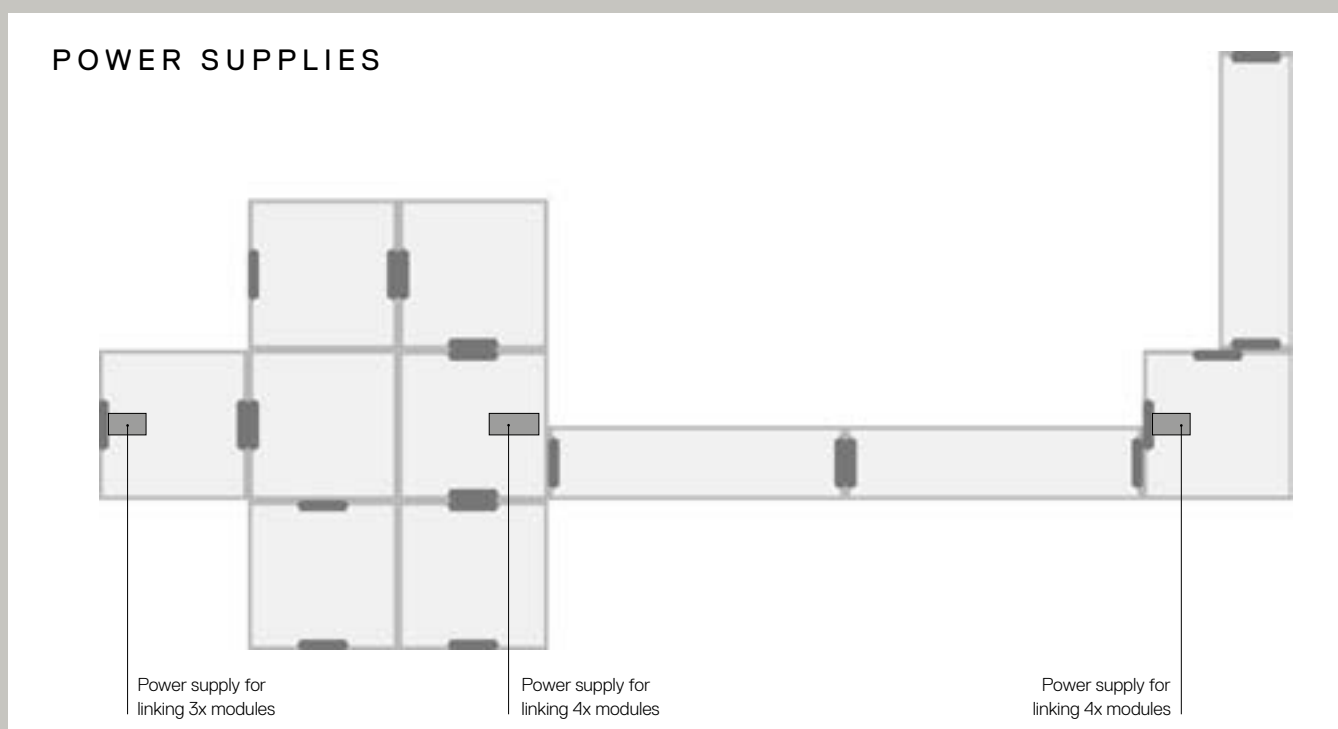
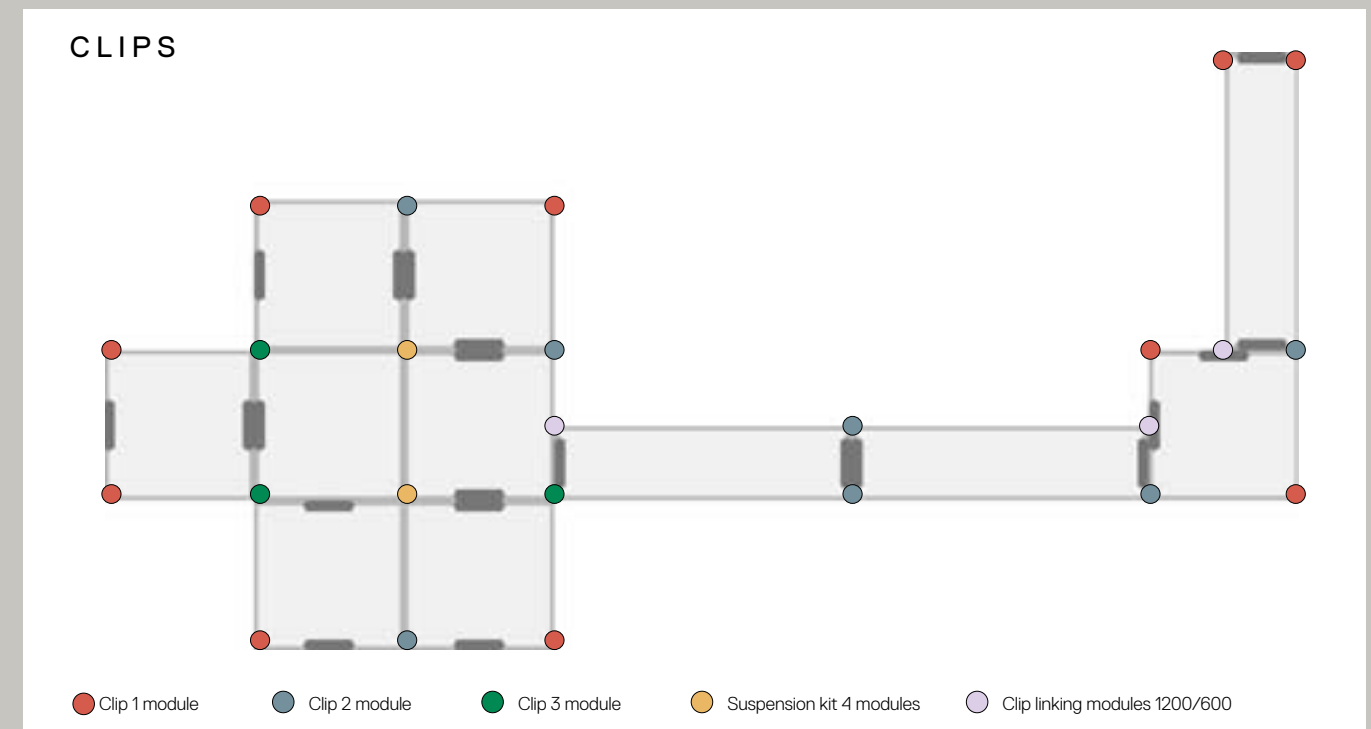
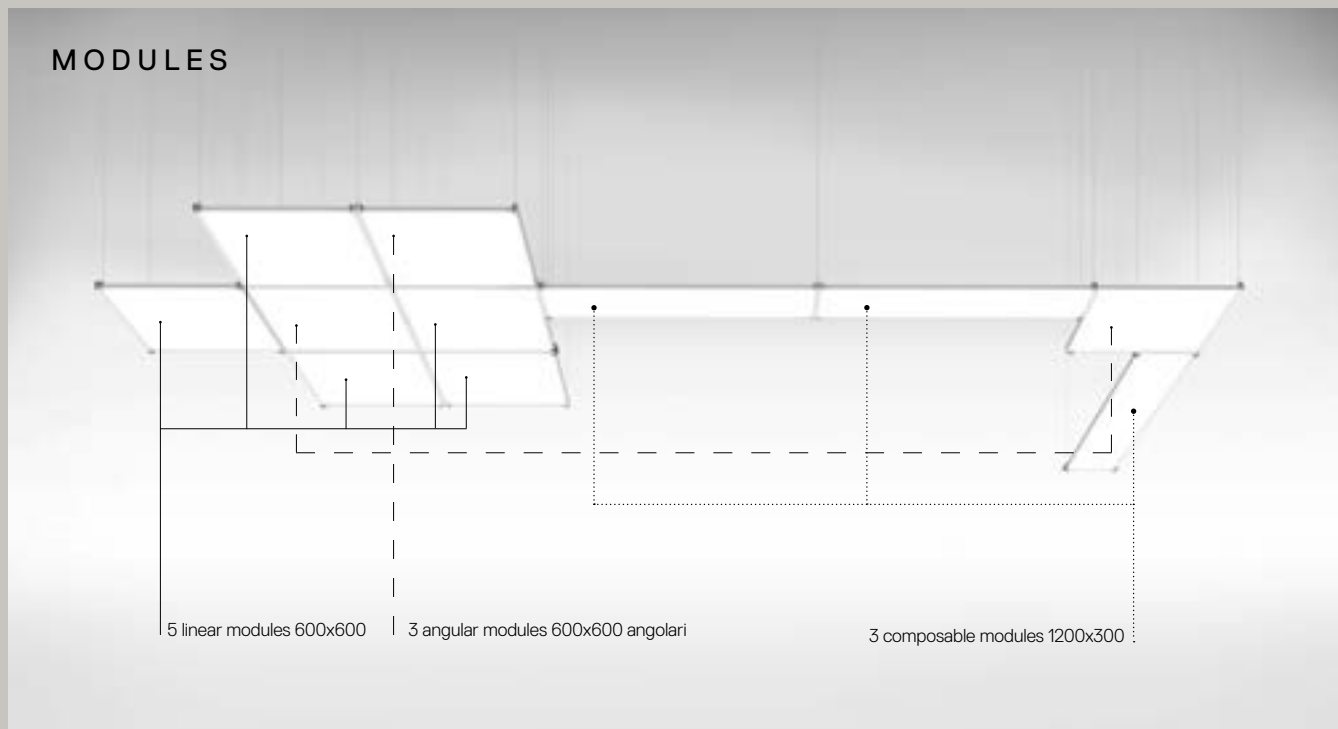

Silver    XF    Clips supplied separately. Driver SELV supplied separately.    MacAdam 2SDCM Life L70 (6K) 50000h UGR < 19 CRI =80 (typ.)    IP20

**Structural Module 600x600**

Cables	W	Weight	BeamFlux	CCT
linear	39 W	4,00 kg	XF 3400 lm	3000 K
				3886 lm 4000 K
angular	39 W		XF 3400 lm	3000 K
				3886 lm 4000 K

Code
M3003W61
M3003N61
M3004W61
M3004N61

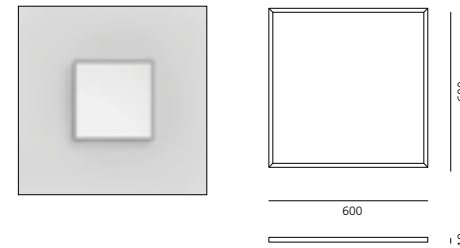

**Structural Module 1200x300**

W	Weight	Beam	Flux	CCT
39 W	4,00 kg	XF	3207 lm	3000 K
			3665 lm	4000 K

Code
M3001W61
M3001N61

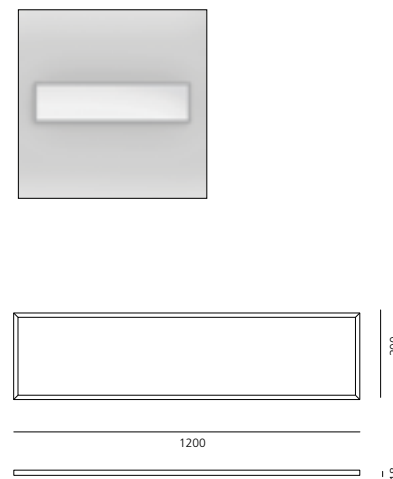

White    Black    Blue    Green    Grey    Red

20    10    30    50    00    40

**Clips**

Clips	Color	Code
<b>1 Clips suspension</b> for singular module 600x600 or 1200x300	○	M3010.20
	●	M3010.30
	●	M3010.50
	●	M3010.00
	●	M3010.10
	●	M3010.40
<b>1 Clips suspension and connection</b> for 2 modules on the same line 600x600 or 1200x300	○	M3011.20
	●	M3011.30
	●	M3011.50
	●	M3011.00
	●	M3011.10
	●	M3011.40
<b>1 Clips suspension and connection</b> for 3 modules at 90° 600x600	○	M3012.20
	●	M3012.30
	●	M3012.50
	●	M3012.00
	●	M3012.10
	●	M3012.40
<b>1 Suspension kit and central connection</b> for 4 modules 600x600	○	M3013.20
	●	M3013.30
	●	M3013.50
	●	M3013.00
	●	M3013.10
	●	M3013.40
<b>1 Clips suspension and connection</b> with modules 1200x300 or 600x600	○	M3014.20
	●	M3014.30
	●	M3014.50
	●	M3014.00
	●	M3014.10
	●	M3014.40

**Driver**

Driver	Dimmable DALI Code
<b>Rose x 1 module</b> 1 power cable – max. length 1500 mm Occupies 1 DALI address	End M300591
<b>Rose x 2 modules</b> 1 power cable – max. length 1500 mm 1 connection cable 1 power connection cover Occupies 1 DALI address	End and Central M300691
<b>Rose x 3 modules</b> 2 power cables – max. length 1500 mm 1 connection cable 1 power connection cover Occupies 2 DALI addresses	Central M300791
<b>Rose x 4 modules</b> 2 power cables – max. length 1500 mm 2 connection cables 2 power connection covers Occupies 2 DALI addresses	Central M300891
<b>Recess kit for roses</b> 1/2/3/4 modules 105 x 450 mm	M300900

# Grafa

## ↪ Stand-alone

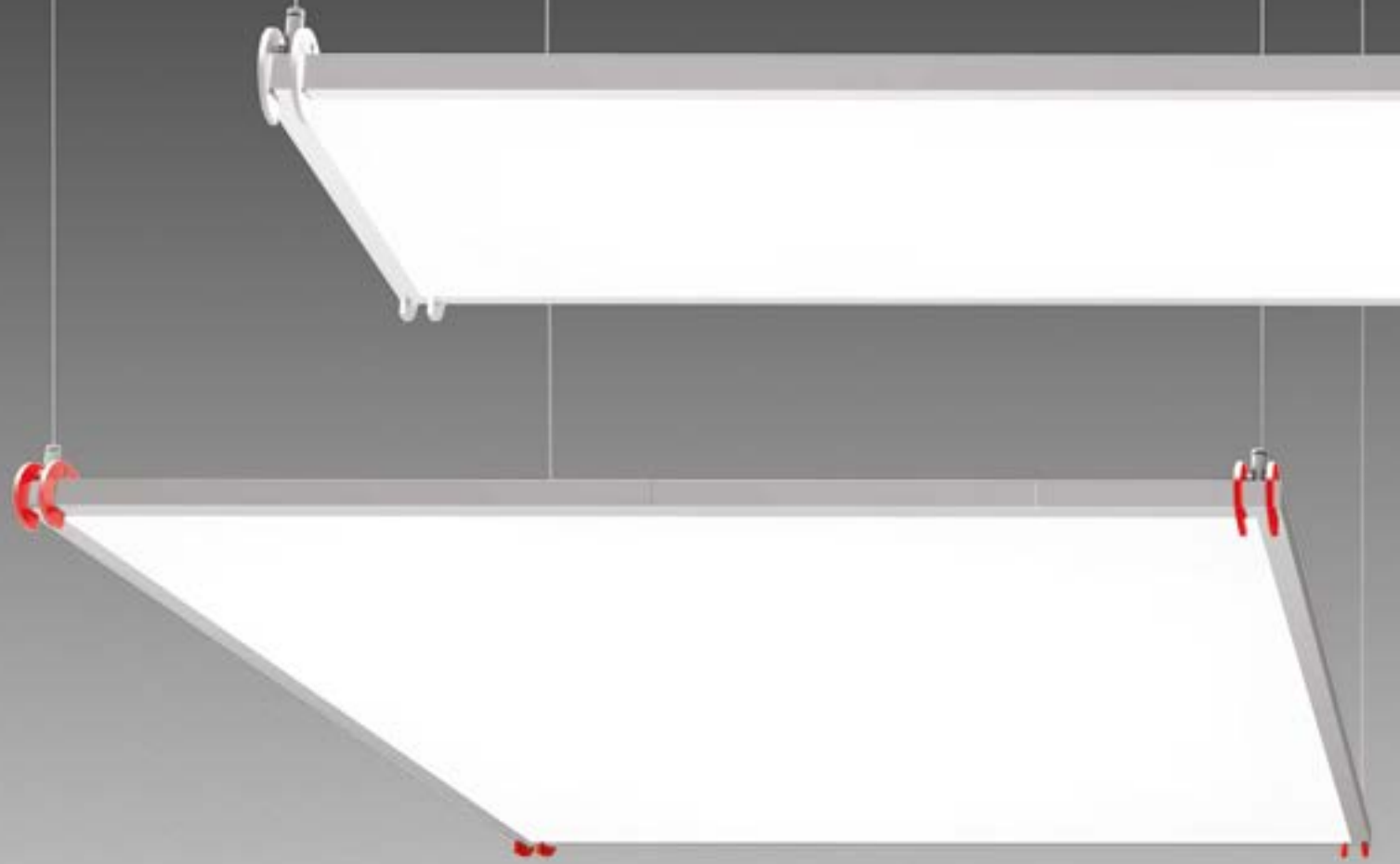

### ↪ GRAFA STAND-ALONE

Silver	XF	White	Black	Blue	Green	Grey	Red	MacAdam 2SDCM	IP20
								Life L70 (6K) 50000h	
		20	10	30	50	00	40	UGR < 19	
								Clips supplied separately..	
								220/240Vac 50/60Hz electronic ballast included.	
								Occupies 1 DALI destination.	

#### Structural module 600x600 Stand-Alone

W	CRI	Weight	Beam	Flux	CCT
39 W	=80 (typ.)	4,00 kg	XF	3400 lm	3000 K
				3886 lm	4000 K

#### DALI+SwitchDim

Code
M3002W61
M3002N61

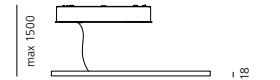
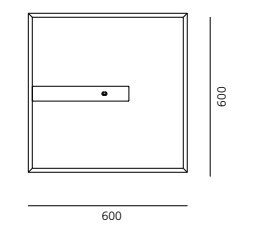
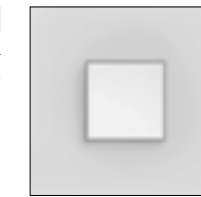

#### Structural module 1200x300 Stand-Alone

W	CRI	Weight	Beam	Flux	CCT
53 W	=80 (typ.)	4,00 kg	XF	5766 lm	3000 K
				6589 lm	4000 K

#### DALI+SwitchDim

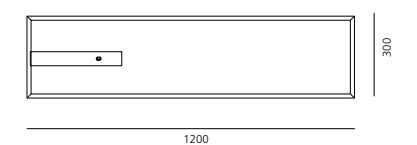
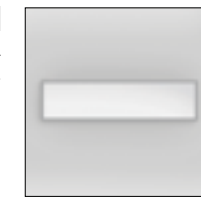

Code
M3000W61
M3000N61



#### Clips

	Color	Code
 4 Clips singular module		M3016.20
		M3016.30
		M3016.50
		M3016.00
		M3016.10
		M3016.40

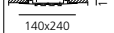
#### Recess kit for roses 1/2/3/4 modules

 140x240 100	 105 x 200 mm	M3015.00
--	--	----------

# Pad System

Carlotta de Bevilacqua

↪ 2012

Modular system with direct emission and indirect with LED high efficiency.  
Ultra thin profile  
Edge Backlighting Technology  
Installation with suspension.  
Single mounting, in continuous line by angle (90°), free composition.  
Dimmable electronic power supply DALI-SwitchDim.  
Materials: structure in extruded aluminum.  
Suspension cables in steel with quick adjustment.  
Complies with EN62471, EN60598-1 and other specific standards.



For further information on Pad System  
↪ visit [artemide.com](http://artemide.com)



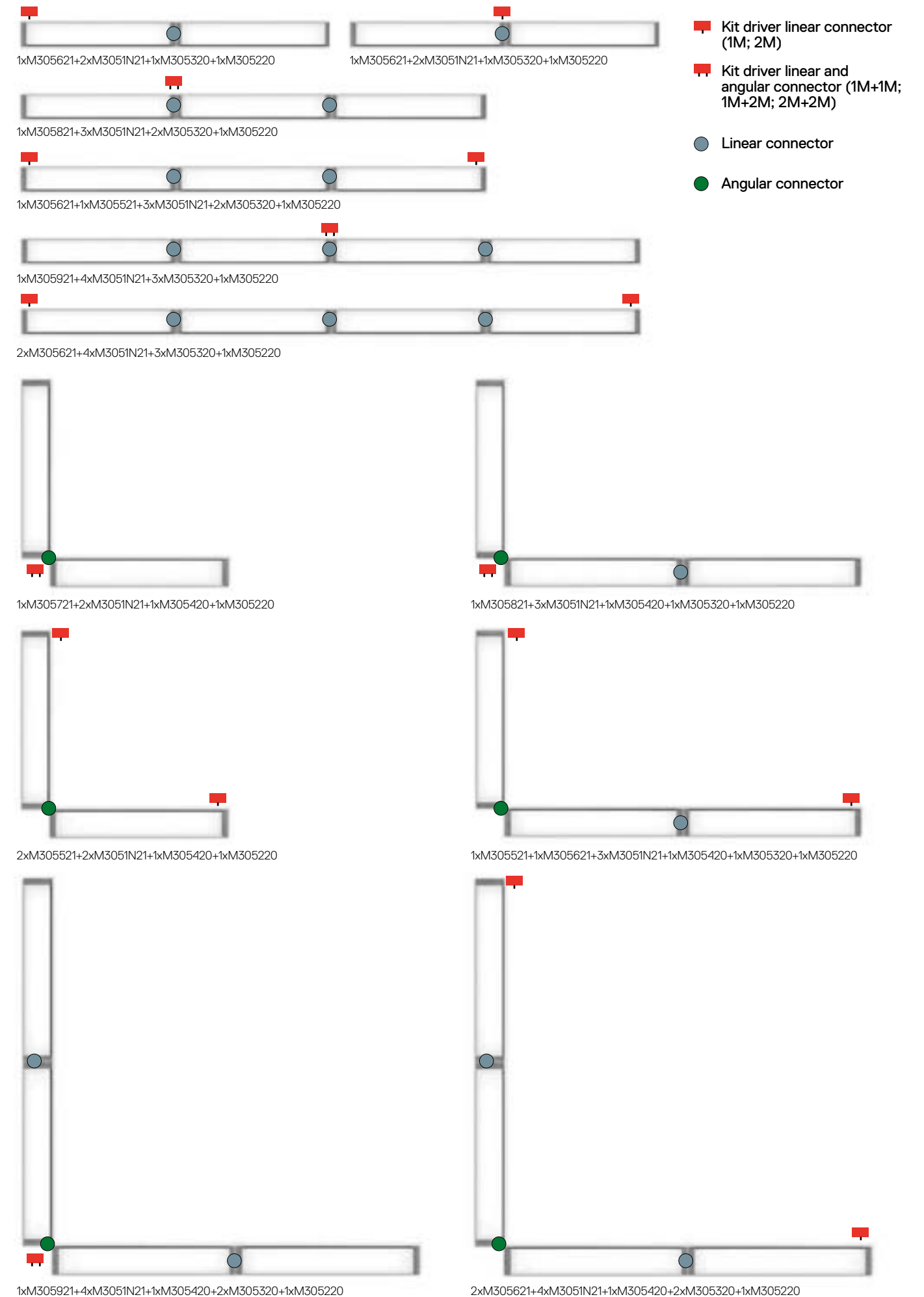

**Artemide  
App**  
↪ on request

# Pad System configuration



## ↪ PAD SYSTEM

White	XF	MacAdam 2SDCM IP20
		Life L70 (6K) 50000h
		UGR <19
		CRI =80



### PAD SYSTEM

W	Weight	Beam	Flux	CCT	Code
39 W	4,03 kg	XF	3062 lm	3000 K	<b>M3051W21</b>
			3499 lm	4000 K	<b>M3051N21</b>

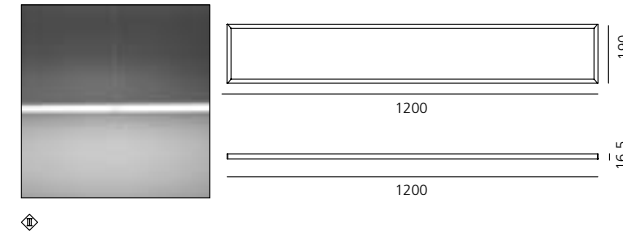



Driver SELV supplied separately.

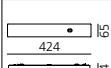
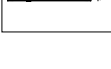

#### Accessories

	End cap + suspension kit	Code <b>M305220</b>
	Linear joint +2 suspension kit	<b>M305320</b>
	90° shaped connector +2 suspension kit	<b>M305420</b>

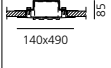
#### Accessories

	Kit driver linear connector 1M Occupies 1 DALI address.	Code <b>M305521</b>
	Kit driver linear connector 2M Occupies 1 DALI addresses.	<b>M305621</b>
	Kit driver linear and angular connector 1M+1M Occupies 1 DALI addresses.	<b>M305721</b>
	Kit driver linear and angular connector 1M+2M Occupies 2 DALI addresses.	<b>M305821</b>
	Kit driver linear and angular connector 2M+2M Occupies 2 DALI addresses.	<b>M305921</b>
	Recess kit for roses 1/2/3/4 modules 105 x 450 mm	<b>M300900</b>

### PAD SYSTEM STAND-ALONE

W	Weight	Beam	Flux	CCT	DALI - SwitchDim Code
53 W	4,03 kg	XF	5569 lm	3000 K	<b>M3050W21</b>
			6365 lm	4000 K	<b>M3050N21</b>

UGR<19  
220/240Vac 50/60Hz electronic ballast included.

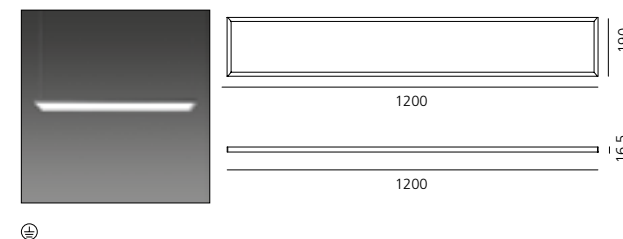

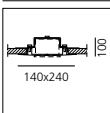
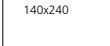
	Recess kit for roses	Code <b>M301500</b>
	105 x 200 mm	

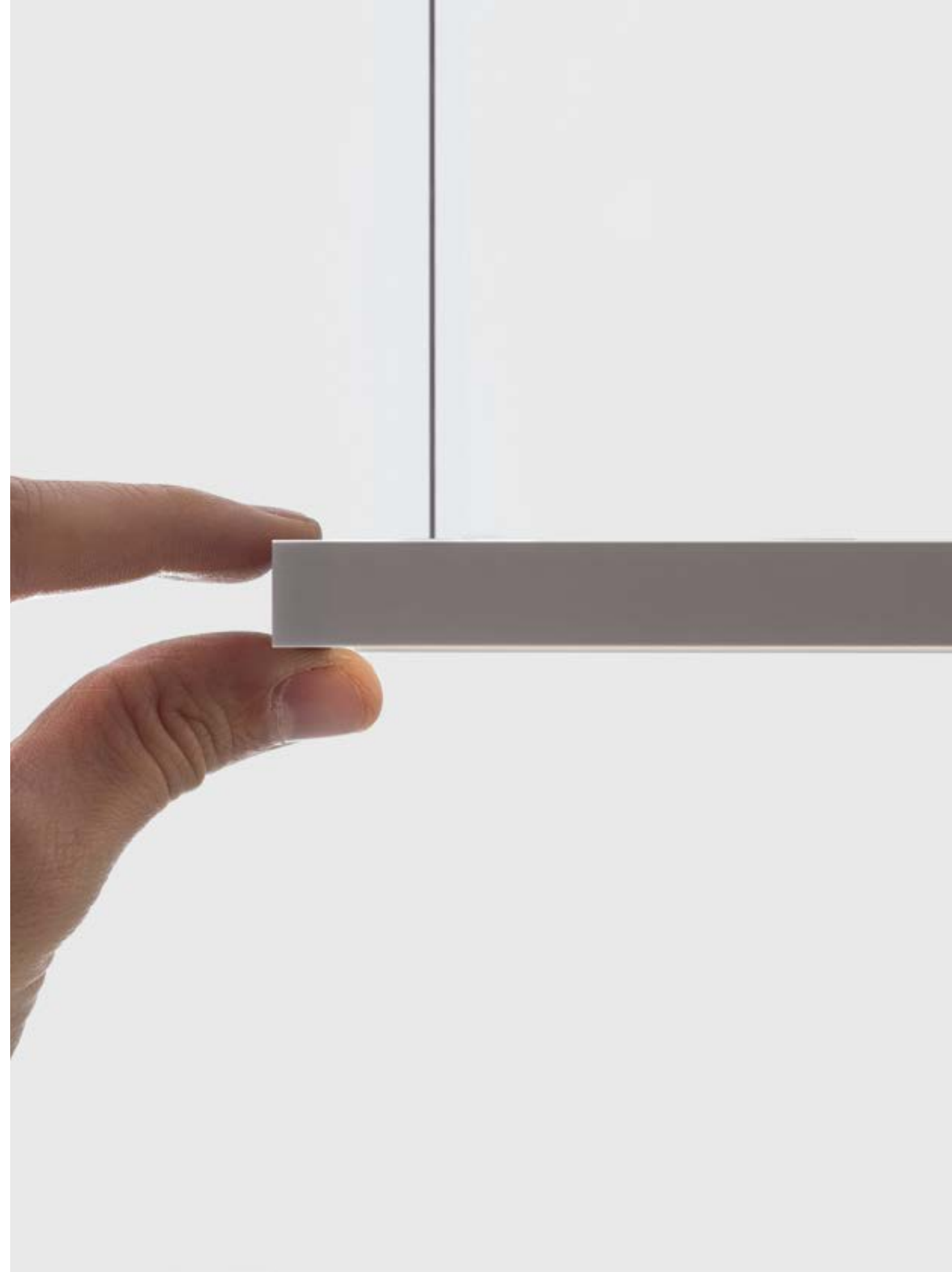



# Uglare 19

↪ 2015

Uglare is 600x600 and 300x1200 recessed ceiling light, suited to illuminate working areas with video-terminals.

Its strong steel and aluminium mechanical construction and high performance (over 100lm/W for the 4000K version), as well as the possibility to adjust the luminous flow, make this appliance ideal to illuminate work areas that require minimum incidence in terms of actual and perceived volumes of lighting systems.



**Artemide App**  
↪ on request

## ↪ UGLARE 19

Glossy white



20

XF



220/240Vac 50/60Hz electronic ballast included.

MacAdam 4SDCM  
Life L70 (10K) 50000h  
UGR <19  
CRI =80

IP40  
650°  
IK10

### 600x600

W	Weight	Beam	Flux	CCT
35 W	3,90 kg	XF	3132 lm 3257 lm	3000 K 4000 K

### Dimmable 1:10V

Code
<b>M032500</b>
<b>M032600</b>

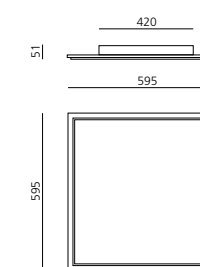

### 300x1200

W	Weight	Beam	Flux	CCT
35 W	3,90 kg	XF	3117 lm 3304 lm	3000 K 4000 K

### Dimmable 1:10V

Code
<b>M031500</b>
<b>M031600</b>

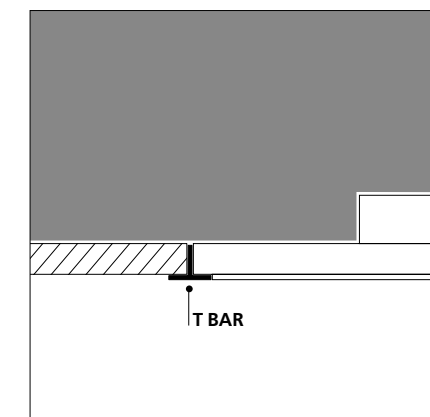
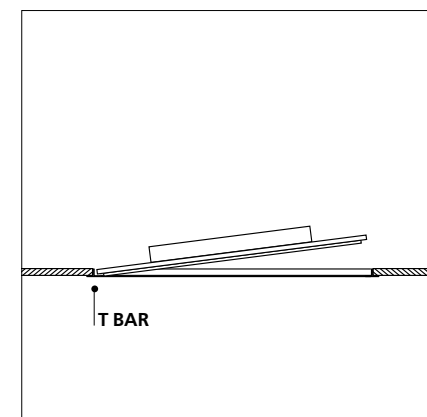
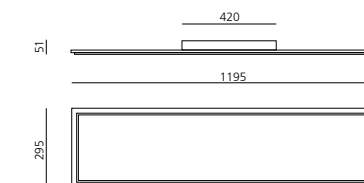

Installation with luminaire incorporated into the 600 modular ceiling structure.



For further information on Uglare19  
↪ visit [artemide.com](http://artemide.com)



# Chocolate floor

a.g.Licht  
↪ 2013

Luminous flux distribution: Version 1 desk – 800x1600mm: Total flux produced consists of 35% direct emission and 65% indirect emission.

Version 2 desk – 1600x1600mm: Total flux produced consists of 50% direct emission and 50% indirect emission.

Two options of light management: dimmable with manual independent control of direct and indirect emission, or Interactive DALI system offering automatic control of illumination on the working plane. A single button allows you to set the desired light with Interactive DALI option.

2 colours: brown and white.

Materials: head and stem in polished aluminium, base in polished aluminium, optics in metallized plastic, diffuser in clear polycarbonate.

Compliant with standard EN60598-1 and other specific regulations.



For further information on Chocolate  
↪ visit [artemide.com](http://artemide.com)





Chocolate terra LED 1-desk



Chocolate terra LED 2-desks



The innovative optic system, specifically made with 108 micro-reflectors, allows a dazzle-free, controlled and concentrated light emission for single workspaces (800x1600mm, 1-desk version) or double workspaces (1600x1600mm, 2-desks version).

The aluminium profile works as heat sink to dissipate heat. Driver and components are located in the central compartment. The 4 LEDs located in each corner are protected by an integral anti-dust screen.

## ↪ CHOCOLATE TERRA LED

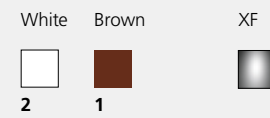

MacAdam 4SDCM direct  
MacAdam 3SDCM indirect  
Life L70 (6K) 36300h direct  
Life L70 (6K) 50000h indirect  
CRI= 80

IP20

### 1 DESK

W	Weight	Flux	CCT	Dimmable Code	Interactive DALI Code
51 W indirect	14 kg	3771 lm	3000 K	<b>M0362. 1/2 .1</b>	<b>M0362. 1/2 .6</b>
30 W direct		1614 lm			
		4036 lm	4000 K	<b>M0363. 1/2 .1</b>	<b>M0363. 1/2 .6</b>
		1727 lm			



Direct emission

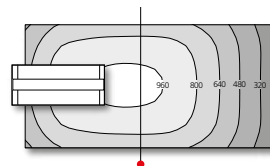

Indirect emission

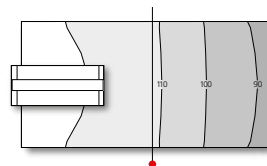

Double emission

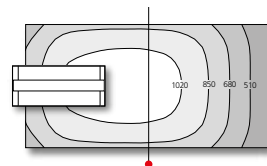

• UGR < 19 transversely to a table

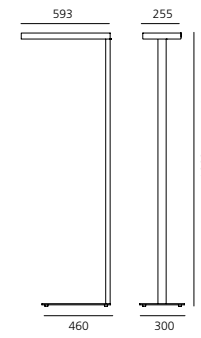

### 2 DESKS

W	Weight	Flux	CCT	Dimmable Code	Interactive DALI Code
50 W indirect	14 kg	3680 lm	3000 K	<b>M0364. 1/2 .1</b>	<b>M0364. 1/2 .6</b>
45 W direct		2984 lm			
		3938 lm	4000 K	<b>M0365. 1/2 .1</b>	<b>M0365. 1/2 .6</b>
		3193 lm			

Direct emission

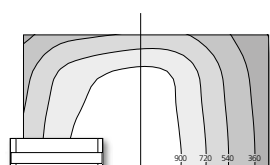

Indirect emission

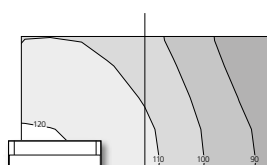

Double emission

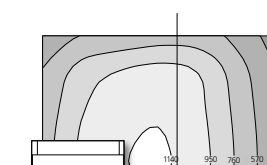

• UGR < 19 transversely to a table

### ECO COMFORT

One power	W	Weight	Flux	CCT	Undimmable Code	Dimmable Code	Interactive DALI Code
26 W indirect	14 kg	4120 lm	3000 K	<b>M0366W.1/2 .0</b>	<b>M0366W.1/2 .1</b>	<b>M0366W.1/2 .6</b>	
51 W direct		3399 lm					
		4339 lm	4000 K	<b>M0366N. 1/2 .0</b>	<b>M0366N. 1/2 .1</b>	<b>M0366N. 1/2 .6</b>	
		3580 lm					



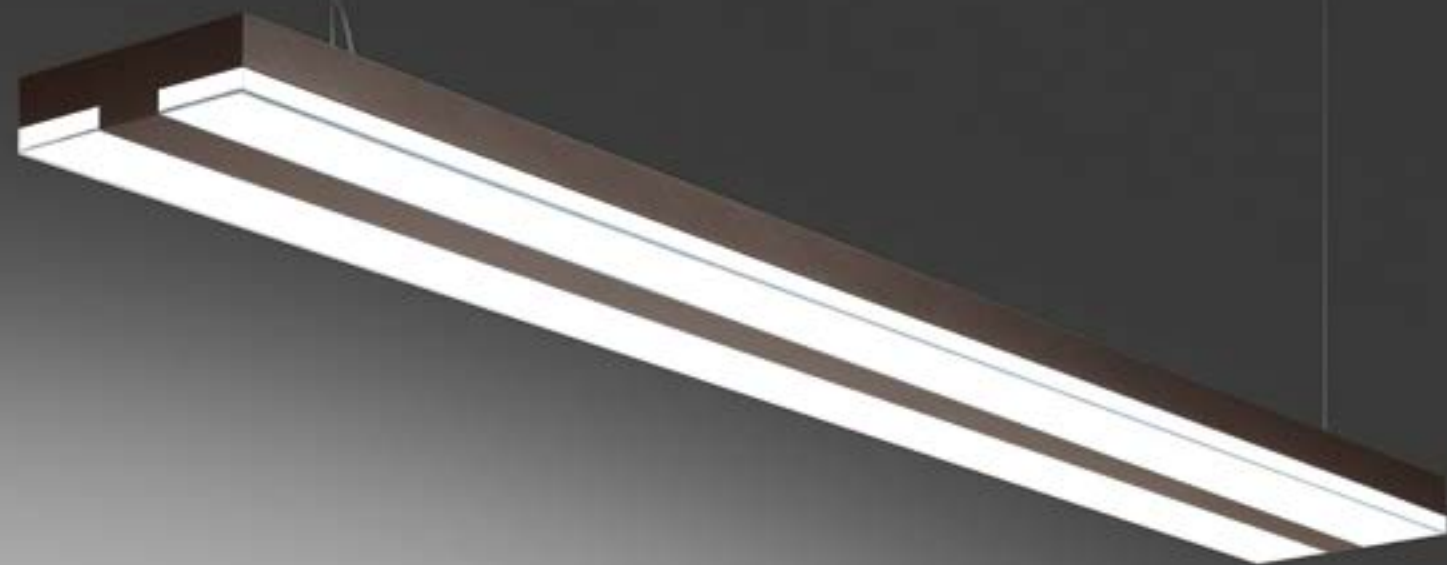

# Chocolate suspension

a.g. Licht  
↪ 2009



# Chocolate wall

a.g. Licht  
↪ 2008

White 2 Brown 1 XF

220/240Vac 50/60Hz electronic ballast included.

MacAdam 4SDCM  
Life L70 (6K) 50000h indirect  
CRI= 80

IP20  
⊕  
850°

W	Weight	Flux	CCT	Undimmable Code	DALI dimmable Code
63 W	4,6Kg	3868 lm	3000 K	<b>M1136.</b> 1/2 .0	<b>M1136.</b> 1/2 .1
		4136 lm	4000 K	<b>M1137.</b> 1/2 .0	<b>M1137.</b> 1/2 .1

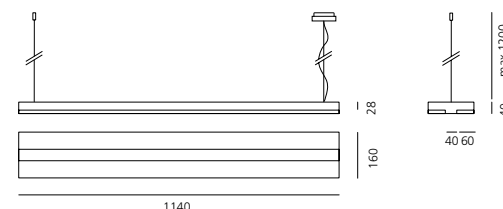

  
**Artemide App**  
 ↪ on request

White 2 Brown 1 XF

220/240Vac 50/60Hz electronic ballast included.

MacAdam 4SDCM  
Life L70 (6K) 50000h indirect  
CRI= 80

IP20  
⊕  
850°

W	Weight	Flux	CCT	Undimmable Code
<b>L 585</b> 16 W	1,9Kg	1210 lm	3000 K	<b>M1124.</b> 1/2 .0
			4000 K	<b>M1125.</b> 1/2 .0

W	Weight	Flux	CCT	Undimmable Code
<b>L 1145</b> 31 W	3,7Kg	2262 lm	3000 K	<b>M1126.</b> 1/2 .0
		2420 lm	4000 K	<b>M1127.</b> 1/2 .0

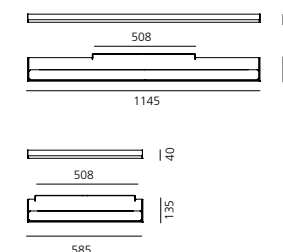

  
**Artemide App**  
 ↪ on request



# Surf System

Neil Poulton

↔ 1998

# Surf System configuration

## SURF SYSTEM SUSPENSION

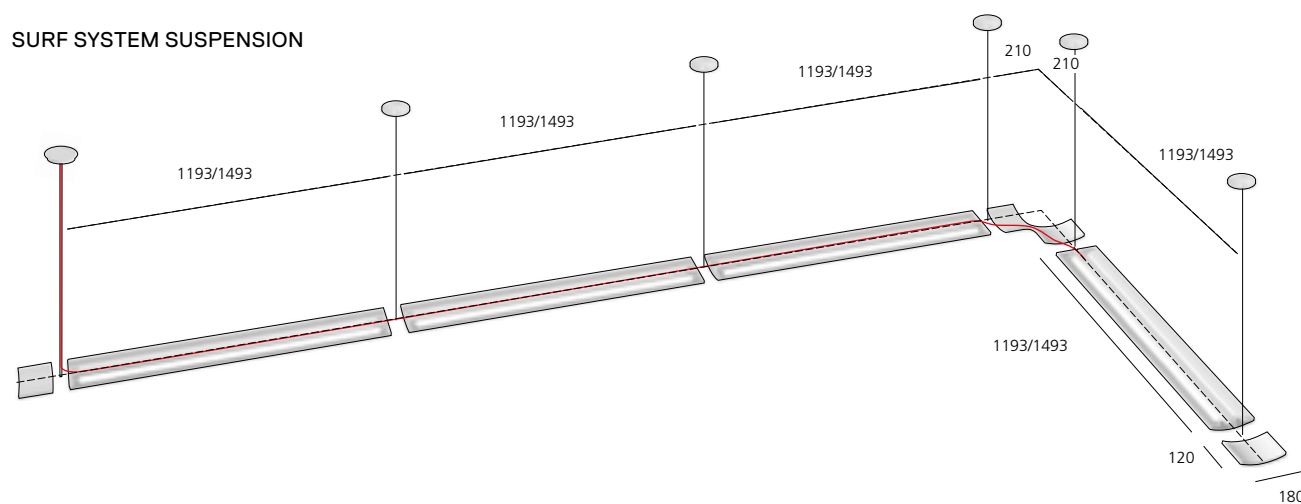

## SURF SYSTEM WALL

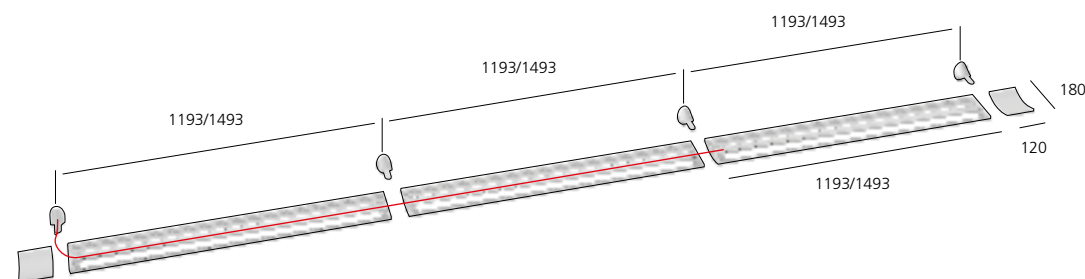

High-performing LED with indirect emission.  
 Ceiling-mounted or suspended.  
 Single installation, in line or angled  
 (L-shaped / 90°, 2-ways, 3-ways, 4-ways).  
 Non-dimmable electronic power supply,  
 DALI dimmable or interactive DALI system,  
 combining presence detector and daylight sensor.

Materials: white painted extruded aluminium body, extruded polycarbonate dust-protective screen.  
 'Quick'-adjustable steel suspension cables.  
 Compliant to standard EN62471, EN60598-1  
 and other specific regulations.





For further information on Surf System  
 ↪ visit [artemide.com](http://artemide.com)



Artemide  
 App  
 ↪ on request









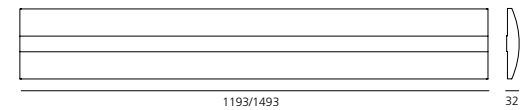

↪ SURF SYSTEM

White 	XF 	220/240Vac 50/60Hz electronic ballast included.	MacAdam 3SDCM Life L90 (20K)=50000h CRI=80	IP20 ⊕ 960°
--	---	---	--	-------------------

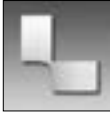
W	Length	Weight	Flux	CCT	Undimmable Code	Dimmable DALI Code
53 W	1193 mm	5,10 kg	6223 lm	3000 K	<b>BD00001</b>	<b>BD01001</b>
			6544 lm	4000 K	<b>BD00101</b>	<b>BD01101</b>



Accessories

	Code		Code
 End cap 120x180 mm 0,70 kg	<b>M090220</b>	 Wall fixing without power supply 55x90 mm protusion 50 mm	<b>M090820</b>
 L-shaped connector 300x300 mm 1,50 kg	<b>M090320</b>	 Wall fixing with power supply (3/5 poles) 55x90 mm protusion 50 mm	<b>M090920</b>
 3-way connector 421x300 mm 2,30 kg	<b>M090420</b>		
 4-way connector 421x421 mm 3,00 kg	<b>M090520</b>		
 Steel suspension cable ceiling plate ø100 mm	<b>M090620</b>		
 3 core suspension cable (3x1,5 mm <sup>2</sup> ) ceiling plate ø100 mm L 1100 mm	<b>M090720</b>		
 5 core suspension cable (3x1,5 mm <sup>2</sup> +2x0,5 mm <sup>2</sup> ) ceiling plate ø100 mm L 1100 mm	<b>M091820</b>		



# Surf Wall



Neil Poulton  
↪ 1998



High-performing LED wall-mounted light fitting.  
More than 3400 lm flux installed.  
High efficiency: more than 70 lumen per watt.  
Materials: body in white painted aluminium.  
Non-dimmable electronic power supply  
or dimmable DALI options.  
Compliant to standard EN62471, EN60598-1  
and other specific regulations.



For further information on Surf Wall  
↪ visit [artemide.com](http://artemide.com)

White 	XF 	220/240Vac 50/60Hz electronic ballast included.	MacAdam 3SDCM Life L70 (6K)> 50000h CRI=80 (typ.)	IP20 ⊕ 960°
--	---	---	---	-------------------

## SURF WALL 300

W	Weight	Beam	Flux	CCT	Undimmable Code	DALI Code
35 W	1,40 kg	XF	2930 lm	3000 K	<b>M060120</b>	<b>M060121</b>
			3078 lm	4000 K	<b>M060220</b>	<b>M060221</b>

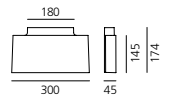

## LED retrofit (R7s)

W	Weight	Beam	Color	Code
max 300 W R7s	1,00 kg	XF	○	<b>M060955</b>





# Acoustic ↪ Collection



# Eggboard

Giacobone & Roj - Progetto CMR  
↳ 2014



For further information on Eggboard  
↳ visit [artemide.com](http://artemide.com)







# Eggboard typologies



Artemide App

## SUSPENSION



EGGBOARD MATRIX  
1600X800



EGGBOARD ACOUSTIC  
1600X800



EGGBOARD MATRIX  
800X800



EGGBOARD ACOUSTIC  
800X800

## SUSPENSION



EGGBOARD BAFFLE  
1600X400



EGGBOARD BAFFLE  
800X400



EGGBOARD DIFFUSED  
1600X400



EGGBOARD ACOUSTIC  
1600X400  
1600X800

## WALL / CEILING



EGGBOARD 1600 X 800

Acoustic panel without light emission  
(optional backlighting modules to be ordered separately)

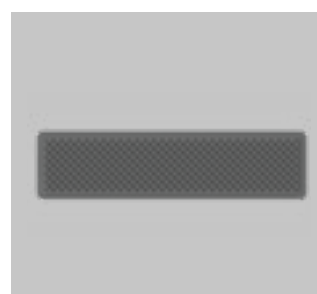

EGGBOARD 1600 X 400

Acoustic panel without light emission  
(optional backlighting modules to be ordered separately)

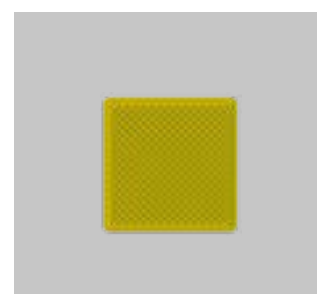

EGGBOARD 800 X 800

Acoustic panel without light emission  
(optional backlighting modules to be ordered separately)

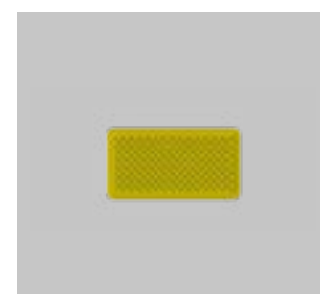

EGGBOARD 800 X 400

Acoustic panel without light emission  
(optional backlighting modules to be ordered separately)

## CEILING



EGGBOARD BAFFLE  
1600X400



EGGBOARD BAFFLE  
800X400



EGGBOARD DIFFUSED  
1600X400

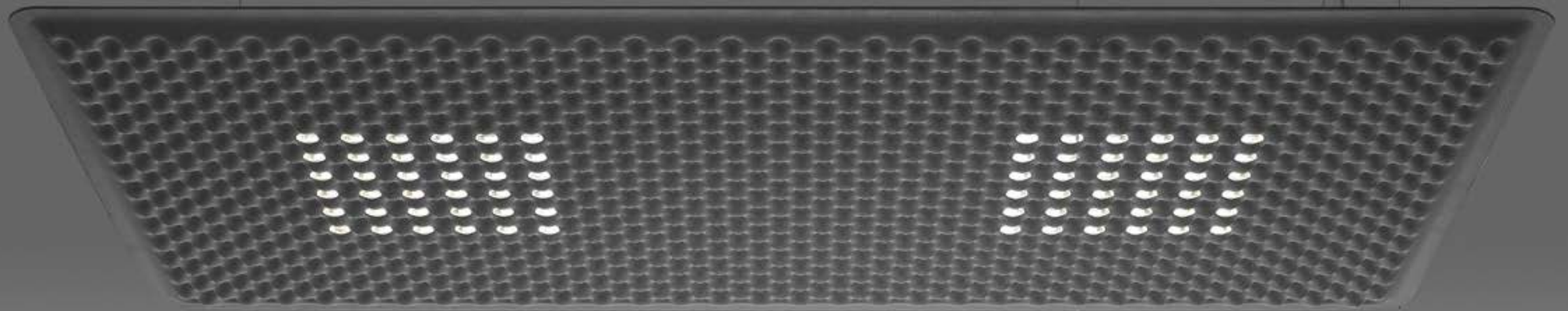

# Eggboard ↪ Matrix

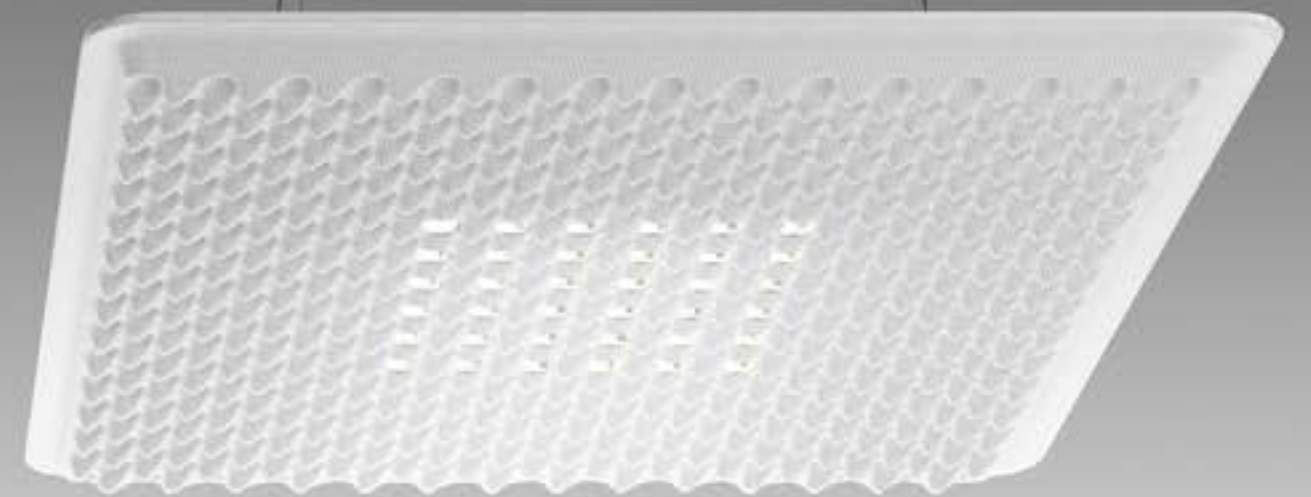

Suspension appliance with sound-absorbing properties ensured by an unusual sinusoidal cross-section design of the lower surface and the use of a sound-absorbing material.

Acoustic efficiency is ensured within a limited space by positioning at approximately one metre above the head of the speaker and listener.

Direct emission: a board with a high number of low-voltage LEDs ensures maximum lighting comfort.

Reflectors can be rotated for use on single or counterposed double desk.

Complies with the norms on office activities that involve the use of video-terminals (UGR<19).

Available in 3 colours (white, grey, green) and 2 different sizes (1600X800mm - 800X800mm).

↳ EGGBOARD MATRIX 1 DESK

↳ EGGBOARD MATRIX 2 DESK

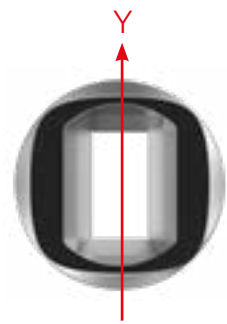
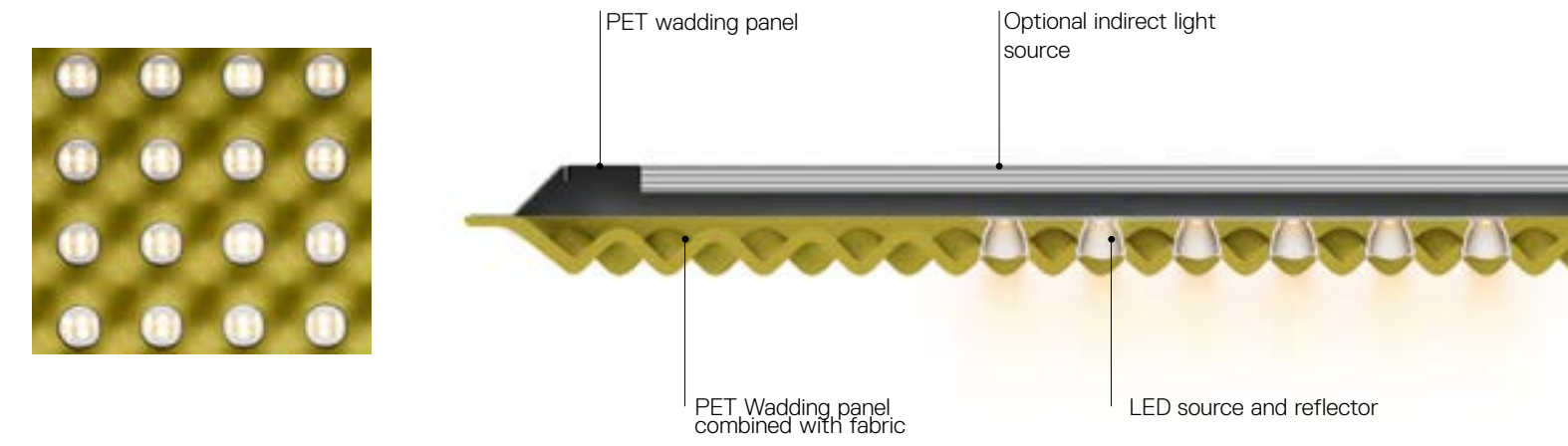
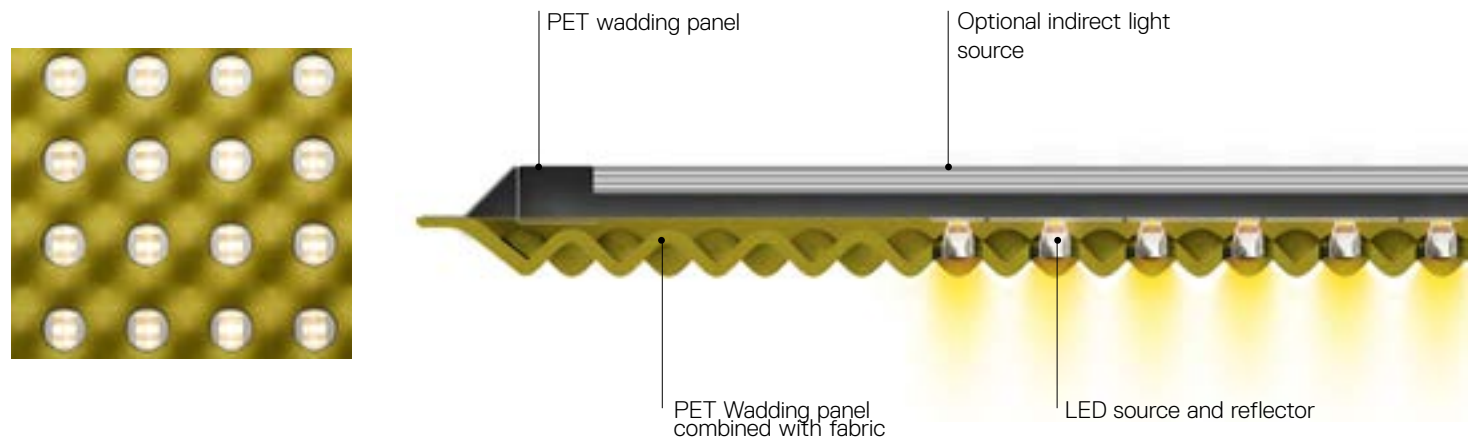

Rotating the elliptic-beam reflector along the Y axis allows to use the product to illuminate one workstation.  
UGR < 12

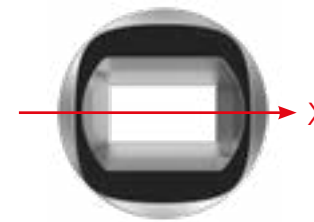
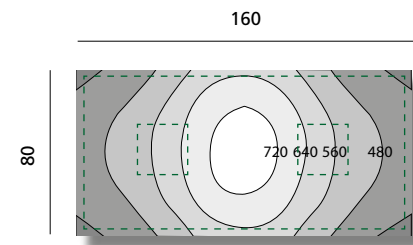

Rotating the elliptic-beam reflector along the X axis allows to use the product to illuminate two workstations.  
UGR < 17

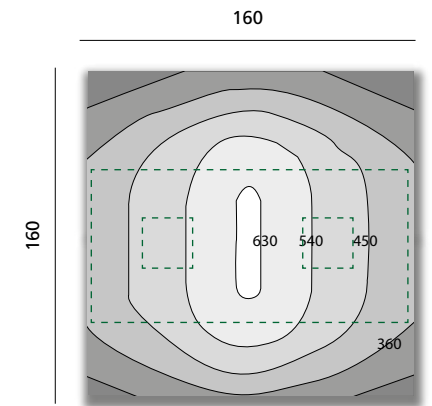



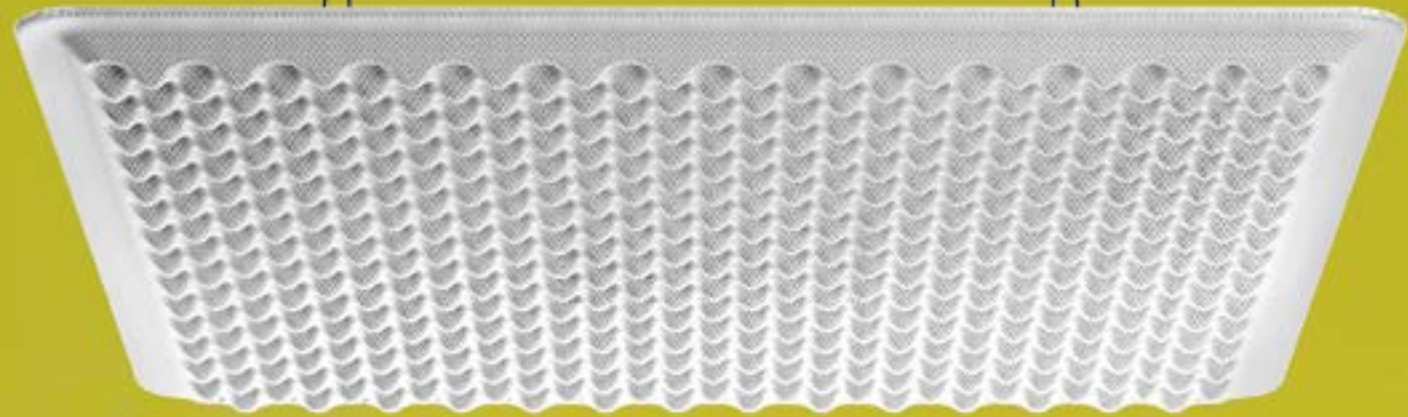

## ↳ EGGBOARD ACOUSTIC PANEL

The sound-absorbing material acts by reducing the reverberation time (i.e. the time required to reduce any noise inside the room by 60 db, so as to ensure that any echoes due to reflections on the walls are inaudible).

The frequency of human voice typically ranges from 1 to 4 kHz.

The use of materials capable to reduce these frequencies allows better understanding of speech and prevents the need to talk loudly to cover the background noise.

The sound-absorbing appliance should be located 400-600 mm off the ceiling to ensure optimal operation.

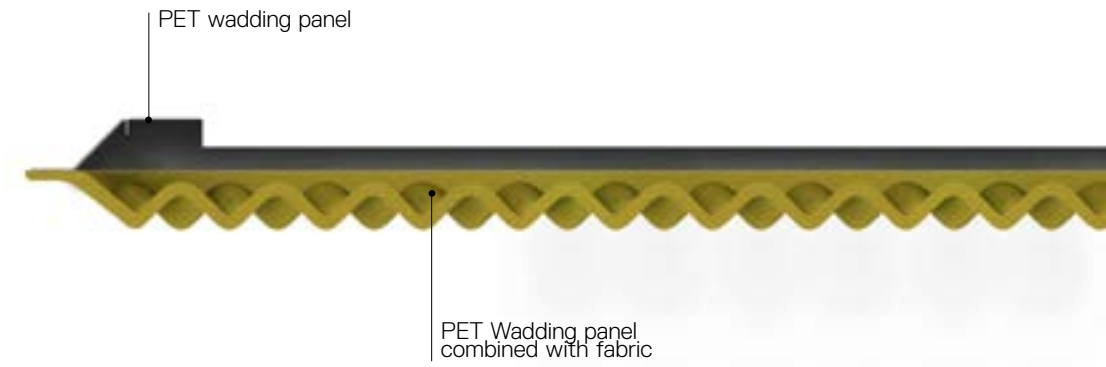



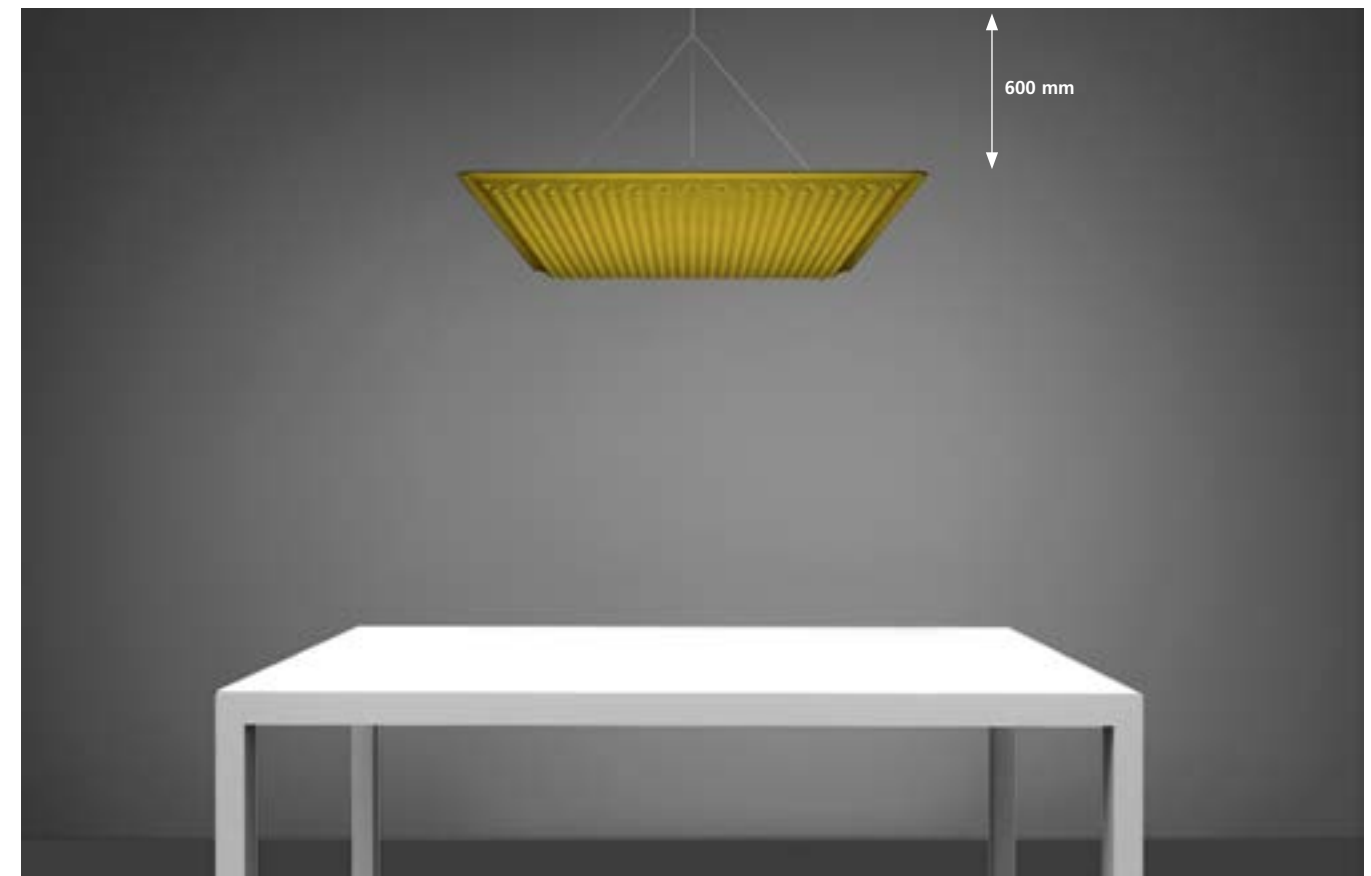
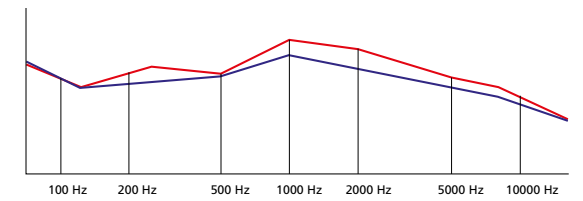

— No sound-absorbing material

— Noise reduction with Eggboard installed 60 cm off the ceiling



## EGGBOARD MATRIX

White cream  2.	Grey  9.	Green  5.	XF 	220/240Vac 50/60Hz electronic ballast included.	MacAdam 3SDCM Direct: Life L90 (10K)>60000h CRI =90 Indirect: Life L80 (10K)>55000h CRI =80	IP20 ⊕ UGR<19
--	---	--	---	---	---	---------------------

### 1600x800

Direct				
W	Weight	Beam	Flux	CCT
31 W	16,5 kg	XF	2402 lm	3000 K
			2488 lm	4000 K

Dimmable DALI	
Code	
<b>M3100W.</b>	2/9/5 .1
<b>M3100N.</b>	2/9/5 .1

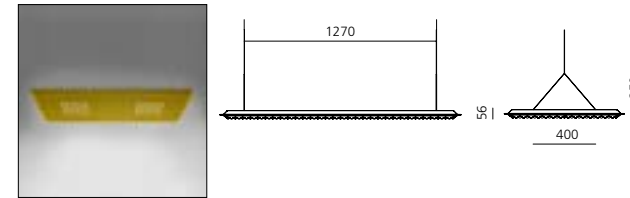

Direct + Indirect				
W	Weight	Beam	Flux	CCT
31 W direct	17,68 kg	XF	2402 lm direct	3000 K
44 W indirect			4030 lm indirect	
			2488 lm direct	4000 K
			4234 lm indirect	

Dimmable DALI	
Code	
<b>M3101W.</b>	2/9/5 .1
<b>M3101N.</b>	2/9/5 .1

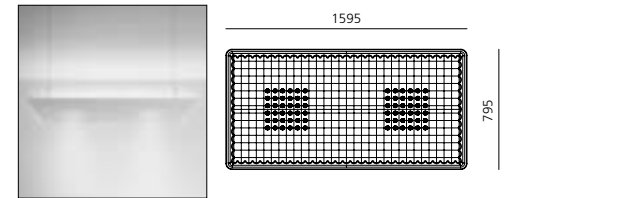

Without light	
Weight	
10 kg	

Code	
<b>M3108.</b>	2/9/5 .0

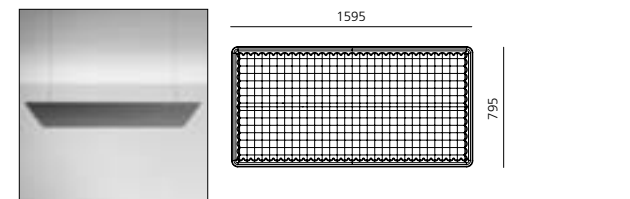

### 800x800

Direct				
W	Weight	Beam	Flux	CCT
16 W	9,20 kg	XF	1200 lm	3000 K
			1244 lm	4000 K

Dimmable DALI	
Code	
<b>M3102W.</b>	2/9/5 .1
<b>M3102N.</b>	2/9/5 .1

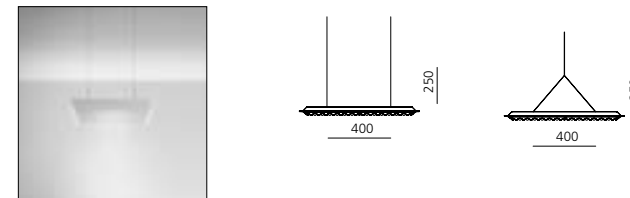

Direct + Indirect				
W	Weight	Beam	Flux	CCT
16 W direct	9,70 kg	XF	1200 lm direct	3000 K
23 W indirect			2015 lm indirect	
			1244 lm direct	4000 K
			2117 lm indirect	

Dimmable DALI	
Code	
<b>M3103W.</b>	2/9/5 .1
<b>M3103N.</b>	2/9/5 .1

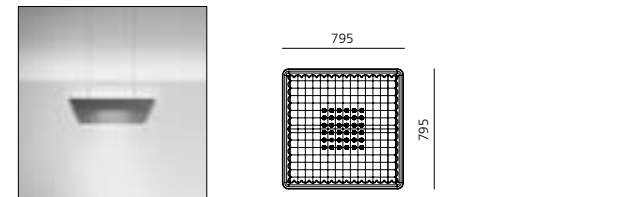

Without light	
Weight	
5 kg	

Code	
<b>M3109.</b>	2/9/5 .0

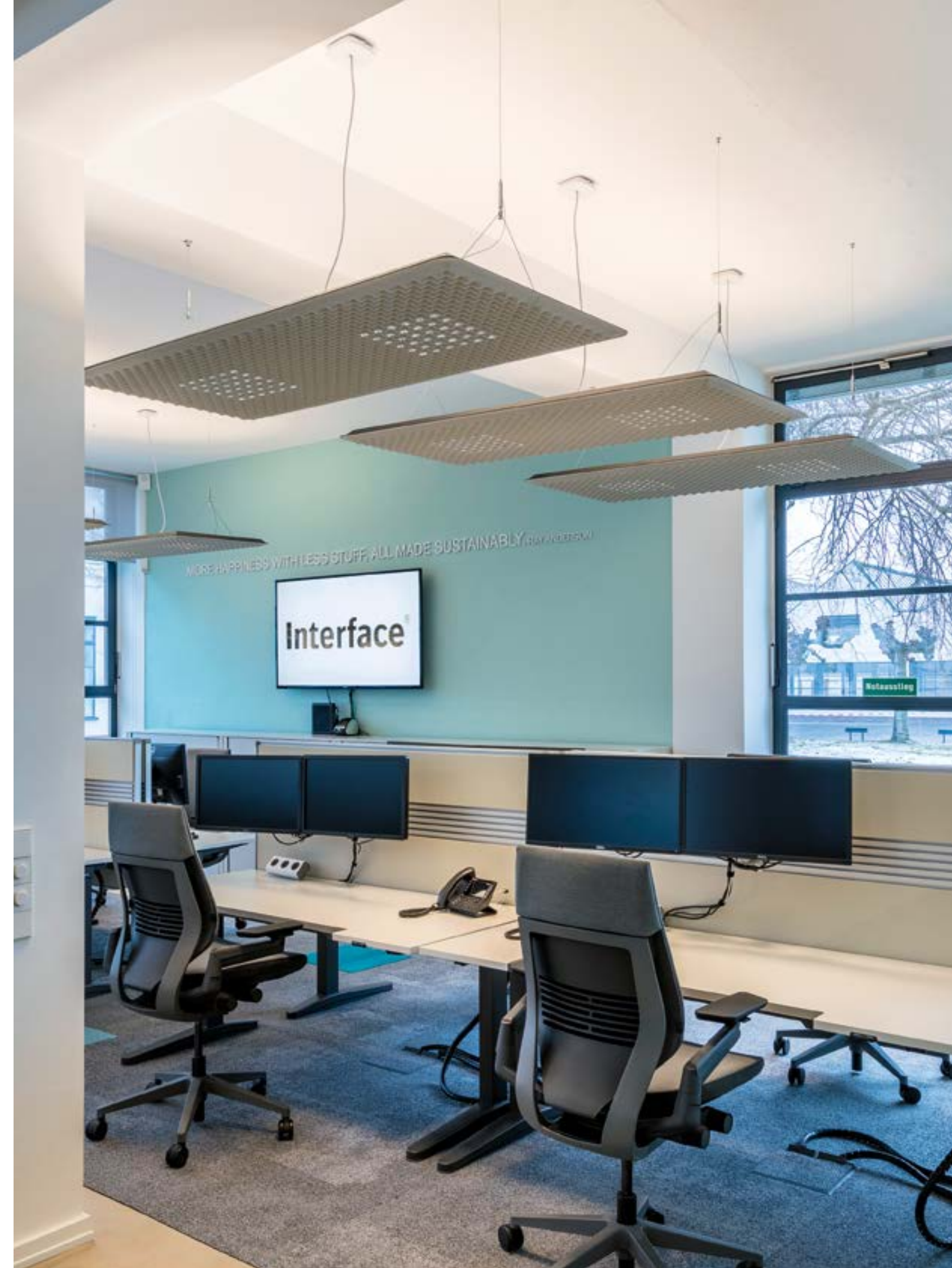
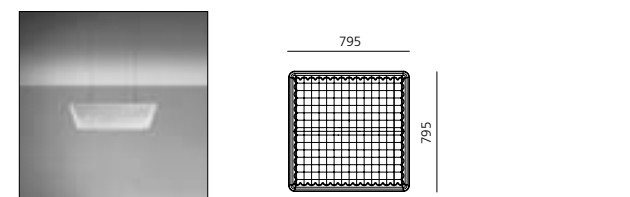

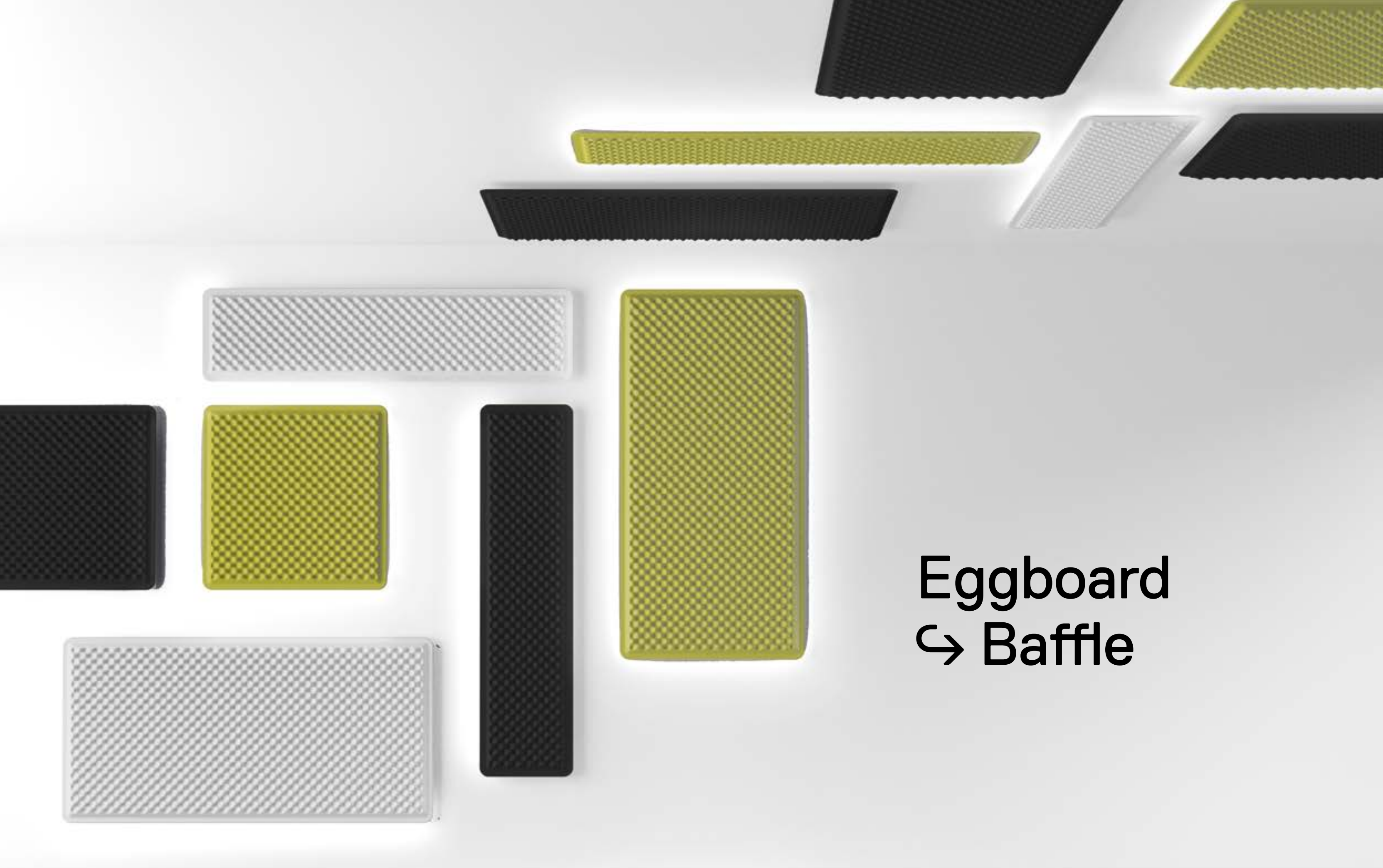

Eggboard  
↪ Baffle



## EGGBOARD BAFFLE

White cream 21	Grey 91	Green 51	XF	220/240Vac 50/60Hz electronic ballast included. For the suspension version, order the ceiling rose or the APP kit separately. For the ceiling version, order only the APP kit separately.	MacAdam 3SDCM Direct: Life L90 (10K)>60000h CRI =90 Indirect: Life L80 (10K)>55000h CRI =80	IP20 ⊕ UGR<19
-------------------	------------	-------------	----	---	---	---------------------

### 1600x400 SUSPENSION / CEILING

Direct				
W	Emission	Beam	Flux	CCT
20 W	sharp	XF	1468 lm	3000 K
			1521 lm	4000 K

Dimmable DALI	
Code	
AZ212.	21/91/51
AZ214.	21/91/51

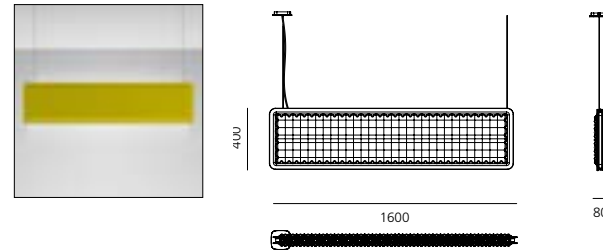

### 1600x400 SUSPENSION

Direct + Indirect				
W	Emission	Beam	Flux	CCT
20 W	direct sharp	XF	1468 lm direct	3000 K
41 W	indirect diffused		4927 lm indirect	
			1521 lm direct	4000 K
			5147 lm indirect	

Dimmable DALI	
Code	
AZ222.	21/91/51
AZ224.	21/91/51



### 800x400 SUSPENSION / CEILING

Direct				
W	Emission	Beam	Flux	CCT
9 W	sharp	XF	667 lm	3000 K
			691 lm	4000 K

Dimmable DALI	
Code	
AZ112.	21/91/51
AZ114.	21/91/51

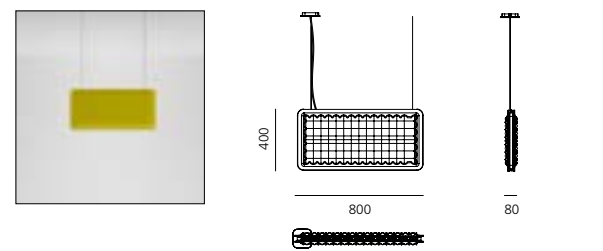

### 800x400 SUSPENSION

Direct + Indirect				
W	Emission	Beam	Flux	CCT
9 W	direct sharp	XF	667 lm direct	3000 K
17 W	indirect diffused		1971 lm indirect	
			691 lm direct	4000 K
			2059 lm indirect	

Dimmable DALI	
Code	
AZ122.	21/91/51
AZ124.	21/91/51



### 1600x400 SUSPENSION / CEILING DIFFUSED

Direct				
W	Emission	Beam	Flux	CCT
41 W	diffused	XF	2715 lm	3000 K
			2837 lm	4000 K

Dimmable DALI	
Code	
AZ232.	21/91/51
AZ234.	21/91/51

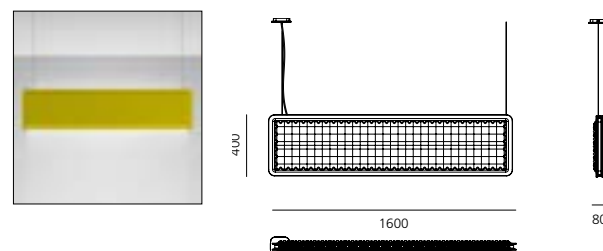

### 1600x400 SUSPENSION DIFFUSED

Direct + Indirect				
W	Emission	Beam	Flux	CCT
41 W	direct diffused	XF	2715 lm direct	3000 K
41 W	indirect diffused		4927 lm indirect	
			2837 lm direct	4000 K
			5147 lm indirect	

Dimmable DALI	
Code	
AZ242.	21/91/51
AZ244.	21/91/51



### Accessories

Canopy + 1 power cable L 210, dimmable DALI only for suspension  
APP power supply kit for suspension + 1 power cable L 210  
BLL DALI interface for APP

Code	
AZ92000	
AZ92100	
AZ92200	

## EGGBOARD ACOUSTIC PANEL / BAFFLE / BACKLIGHT

White cream 21	Grey 91	Green 51	XF	IP20 ⊕
-------------------	------------	-------------	----	-----------

### EGGBOARD BAFFLE SUSPENSION / CEILING

Acoustic panel		Code	
1600 x 800		AZ300.	21/91/51
1600 x 400		AZ200.	21/91/51

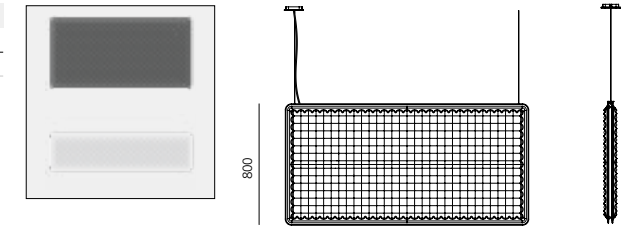

### WALL - CEILING

Acoustic panel		Code	
1600 x 800		AZ800.	21/91/51
1600 x 400		AZ700.	21/91/51
800 x 800		AZ600.	21/91/51
800 x 400		AZ500.	21/91/51

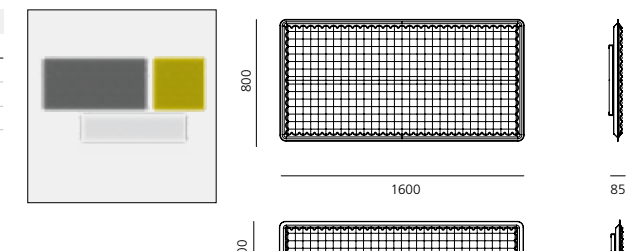

Backlight for acoustic panel						Code	
Side length	W	Beam	Flux	CCT			
1600	32 W	XF	3000 lm	3000 K			AZ90200
							AZ90400
800	16 W	XF	1300 lm	3000 K			AZ90500
							AZ90600
400	9,6 W	XF	500 lm	3000 K			AZ90700
							AZ90800

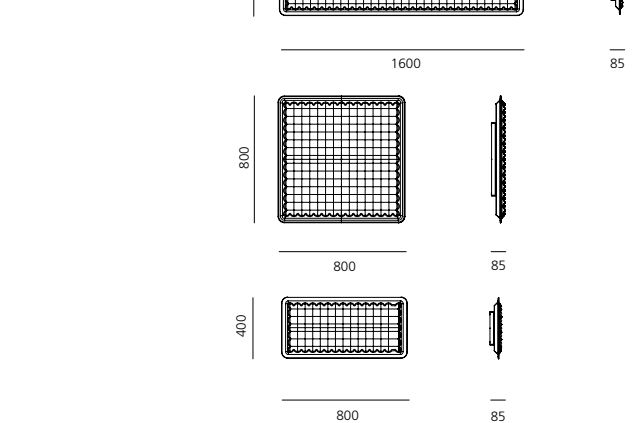
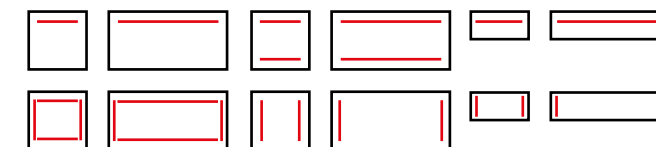

Driver	W	Vin (V)	Vout (V)	L mm	W mm	H mm	W max	Min Wire section mm2	Max wire lenght m	Dimming	Code
CV Selv	30	220-240 Vac	24Vdc	153	41	32	25	1.5	15	no	DV1032
CV Selv	75	220-240 Vac	24Vdc	180	52	30	63	1.5	5	no	DV1009
CV Selv	120	220-240 Vac	24Vdc	300	40	30	102	1.5	3	no	DV1033
Dimmer	NA	24Vdc	24Vdc PWM	80	54	24	max 100	1.5	30	yes	DV1048

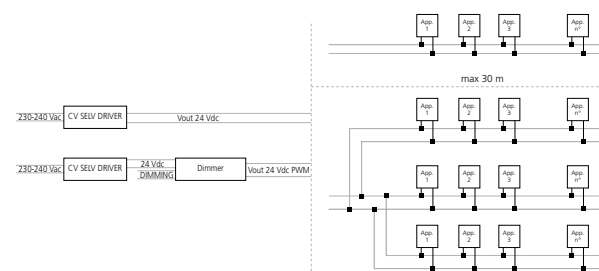

appliances number: see column W max



# Silent Field 2.0

Carlotta de Bevilacqua

Laura Pessoni

↪ 2016



For further information on Silent Field 2.0  
↪ visit [artemide.com](http://artemide.com)



# Silent Field 2.0 is an island of light and silence



Suspension appliance with sound absorption properties: the material's characteristics and the appliance's geometry ensure a reduced reverberation time.

The sound absorption effect is optimized for the frequencies of human voice.

The varying densities of the material used for the lower panel promote the absorption of different frequencies.

Both the upper and the lower surface of the appliance feature sound-absorbing properties. Appropriate positioning of the appliance in space is crucial to optimize sound absorption.



Fixed optics detail



Artemide App

## ↳ SILENT FIELD 2.0

White 20.	Black 30.	Orange 40.	XF	MacAdam 2SDCM Life L90 (20k)>118000h CRI =90	IP20
--------------	--------------	---------------	----	--	------

Direct emission				PUSH/DALI	PUSH & APP
W	Beam	Flux	CCT	Code	Code
35W	XF	2085 lm	3000K	10140. 20/30/40 .A	10140. 20/30/40 .APP

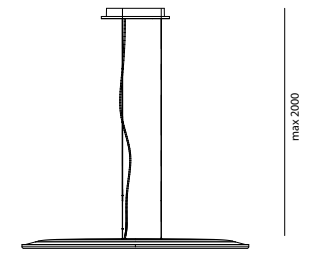

Direct + indirect emission					PUSH/DALI	PUSH & APP
W	Emission	Beam	Flux	CCT	Code	Code
35W	direct	XF	2085 lm	3000K	10130. 20/30/40 .A	10130. 20/30/40 .APP
40W	indirect	XF	3191 lm	3000K		

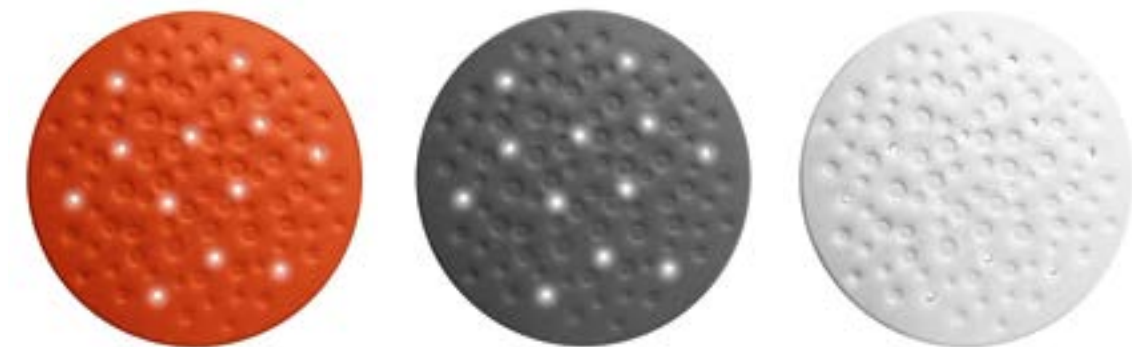
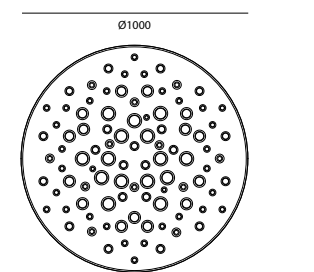

**2 SURFACES FOR DIFFERENT ACOUSTIC ABSORPTION**  
Upper surface with low density to entrap soundwaves reflected from the ceiling

Indirect emission

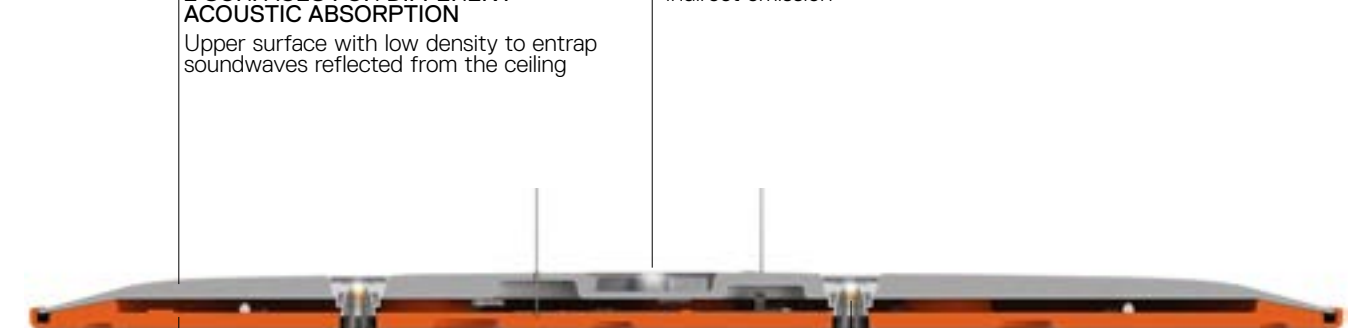

Lower surface with different density to absorb different frequencies

→ PATENT PENDING

High efficiency  
Maximum uniformity & no color spots  
Total control of the light emission





# Nur 1618 Acoustic

Ernesto Gismondi  
↪ 2016



For further information on Nur 1618 Acoustic  
↪ visit [artemide.com](http://artemide.com)



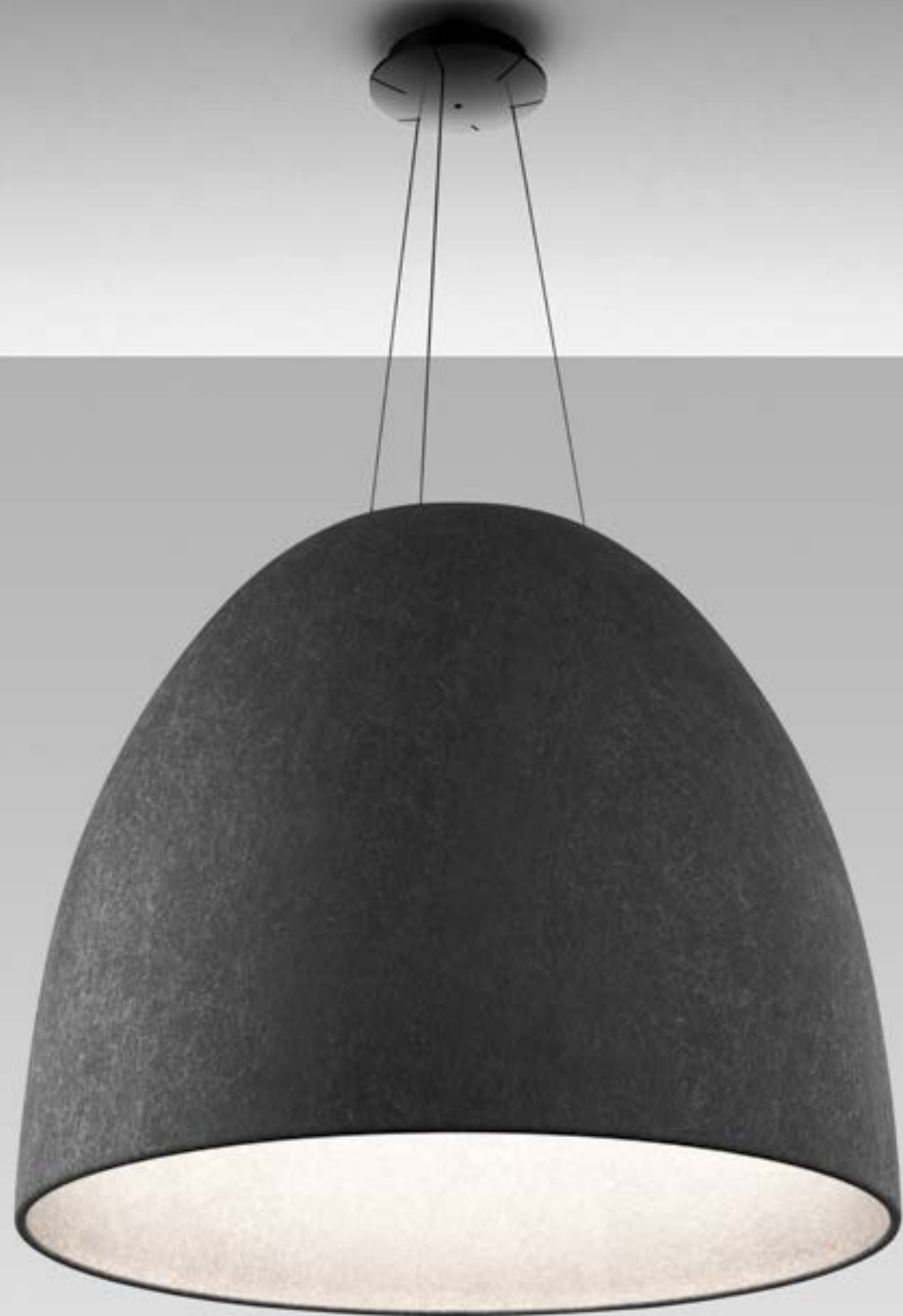

Suspension appliance with sound-absorbing properties: the material's characteristics and the geometry of the dome reduce the reverberation time capturing soundwaves.

The sound-absorption effect is optimized for the frequencies of human voice.

Direct and indirect emission.

Two-colours: white inside optimizes light diffusion.



**Artemide  
App**  
↪ on request

## ↪ NUR 1618 ACOUSTIC

Dark grey



XF



CRI =90

IP20



W	Flux	CCT	Code
80 W	6151 lm	3000 K	A243700

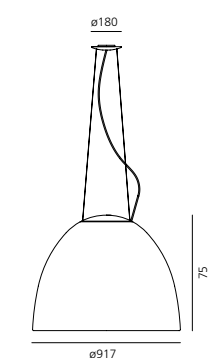

# General Lighting

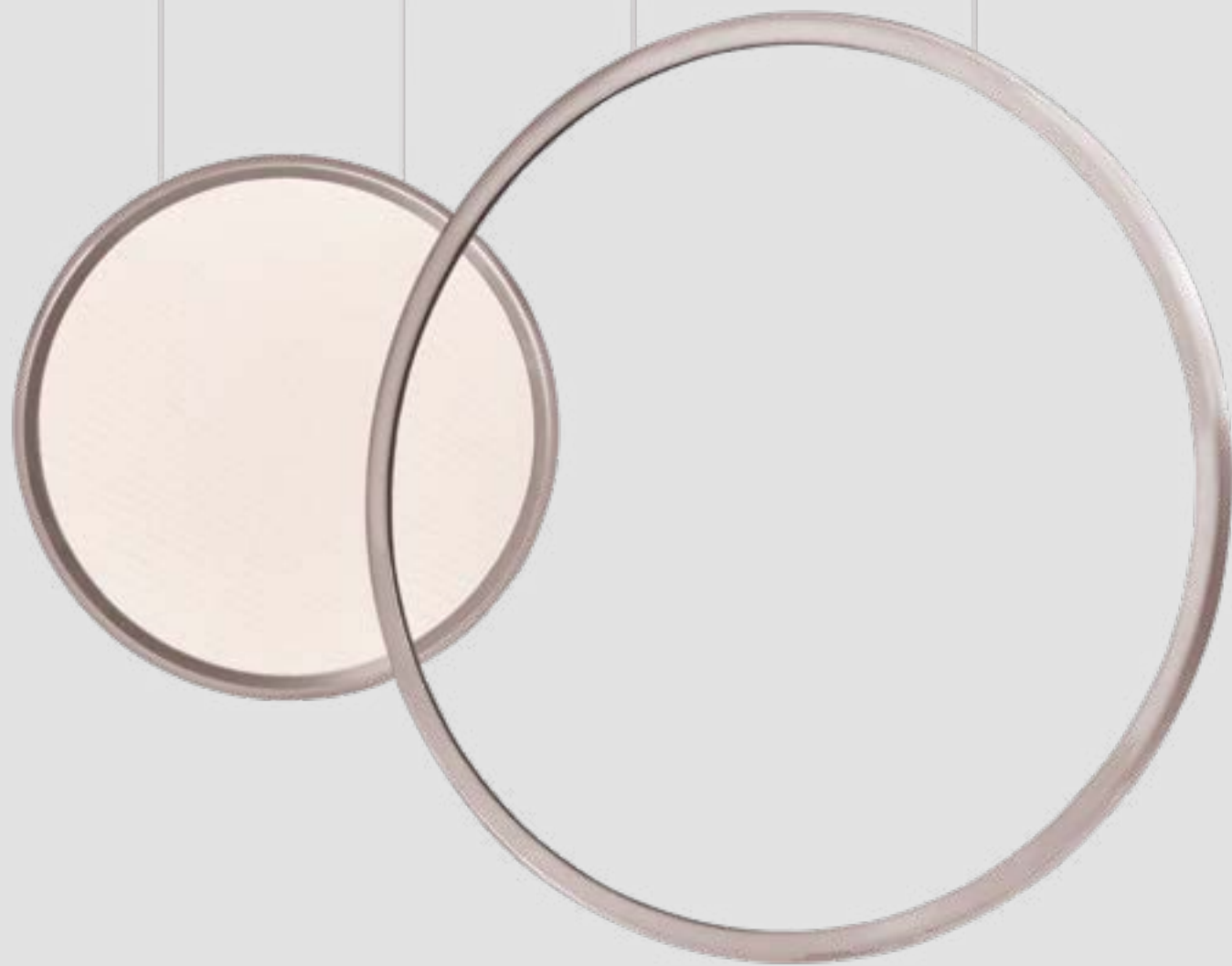

Alphabet of light	_____	580
Discovery	_____	618
Ameluna	_____	638
Tagora	_____	650
Mouette	_____	668

# Alphabet of light

BIG  
↳ 2016



For further information on Alphabet of Light  
↳ visit [artemide.com](http://artemide.com)

"Quick brown fox jumps over the lazy dog" Installation at Università Statale di Milano  
Micro Design Week 2019  
Photo: Saverio Lombardi Vallauri









# Alphabet of light

## ↪ Linear-Circular

- Patent pending for optics
- Patent pending for the mechanical and electrical connection



Materials: structure in anodized natural aluminium,  
tube in white diffusing PMMA  
Linear modules are available in three lengths: L 1200 / 1800 / 2400 mm  
Circular modules are available in two diameters:  
ø tot 900 / 1550 mm



## ↪ ALPHABET OF LIGHT - WALL/CEILING

Opal White XF

The APP driver can not be controlled by DALI dimming system and viceversa.

MacAdam 3SDCM  
Life L80 (10K) 55000h  
CRI = 80

IP20

### LINEAR

	W	Flux	CCT	PUSH/DALI Code	PUSH & APP Code	
Linear 120	35 W	3480 lm	3000K	<b>1304000A</b>	<b>1304000APP</b>	
Linear 180	50 W	5226 lm	3000K	<b>1305000A</b>	<b>1305000APP</b>	
Linear 240	63 W	6968 lm	3000K	<b>1308000A</b>	<b>1308000APP</b>	

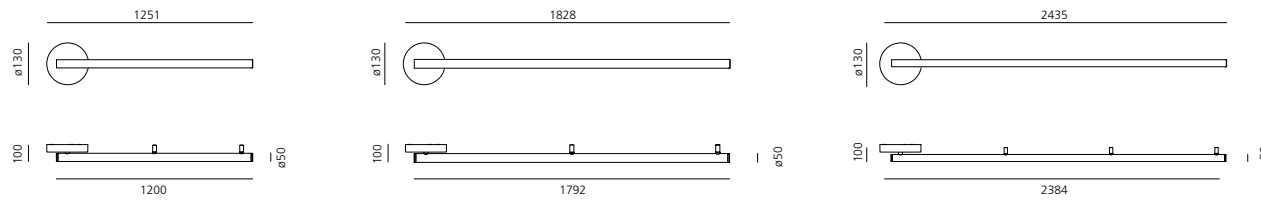

### CIRCULAR

	W	Flux	CCT	PUSH/DALI Code	PUSH & APP Code	
Circular ø 90	55 W	6040 lm	3000K	<b>1306000A</b>	<b>1306000APP</b>	
Circular ø155	91W	10740 lm	3000K	<b>1307000A</b>	<b>1307000APP</b>	

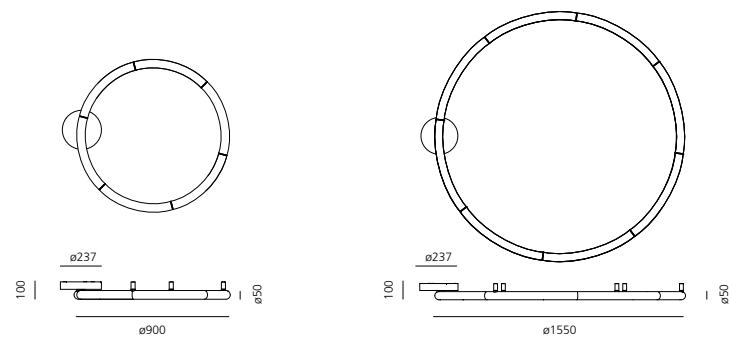

## ↪ ALPHABET OF LIGHT - WALL/CEILING SEMI-RECESSED

Opal White XF

The APP driver can not be controlled by DALI dimming system and viceversa.

MacAdam 3SDCM  
Life L80 (10K) 55000h  
CRI = 80

IP20

### LINEAR SEMI-RECESSED

	W	Flux	CCT	Code	
Linear 120	29 W	3480 lm	3000K	<b>1425000A</b>	
Linear 180	44 W	5226 lm	3000K	<b>1426000A</b>	
Linear 240	58 W	6968 lm	3000K	<b>1427000A</b>	

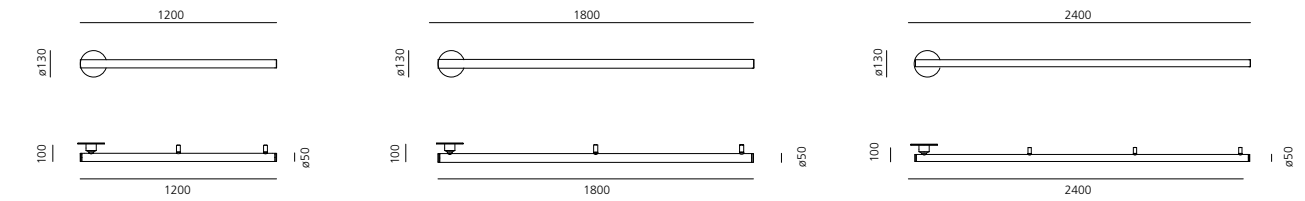

### CIRCULAR SEMI-RECESSED

	W	Flux	CCT	Code	
Circular ø 90	50 W	6040 lm	3000K	<b>1428000A</b>	
Circular ø155	86 W	10740 lm	3000K	<b>1429000A</b>	

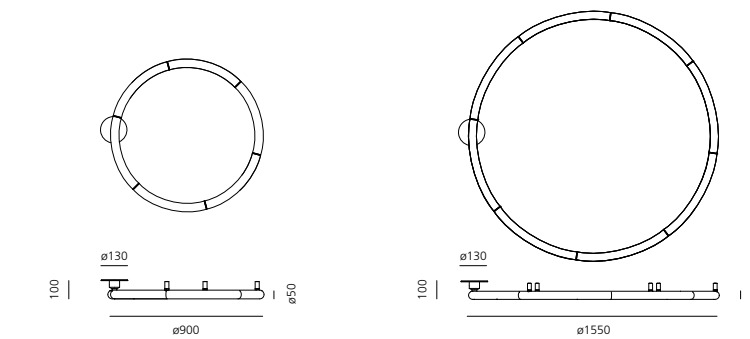

Driver	Vac	L <sub>mm</sub>	W <sub>mm</sub>	H <sub>mm</sub>		Code
CV 30W 24Vdc Selv	220-240	153	41	32	PUSH/DALI	Linear 240/Circular 90 <b>DV1034</b>
CV 75W 24Vdc Selv	220-240	180	52	30	PUSH/DALI	Linear 120/180 <b>DV1035</b>
CV 120W 24Vdc Selv	220-240	153	41	32	PUSH/DALI	Circular 155 <b>DV1036</b>
CV 30W 24Vdc Selv	220-240	153	41	32	PUSH/DALI	Linear 240/Circular 90 <b>DV1034APP</b>
CV 75W 24Vdc Selv	220-240	180	52	30	PUSH & APP	Linear 120-180 <b>DV1035APP</b>
CV 120W 24Vdc Selv	220-240	153	41	32	PUSH & APP	Circular 155 <b>DV1036APP</b>

## ↪ ALPHABET OF LIGHT - SUSPENSION

Opal White    XF



The APP driver can not be controlled by DALI dimming system and viceversa.

MacAdam 3SDCM  
Life L80 (10K) 55000h  
CRI = 80

IP20

### LINEAR

	W	Flux	CCT	PUSH/DALI Code	PUSH & APP Code
Linear 120	35 W	3484 lm	3000K	<b>1204000A</b>	<b>1204000APP</b>
Linear 180	50 W	5226 lm	3000K	<b>1205000A</b>	<b>1205000APP</b>
Linear 240	63 W	6968 lm	3000K	<b>1208000A</b>	<b>1208000APP</b>

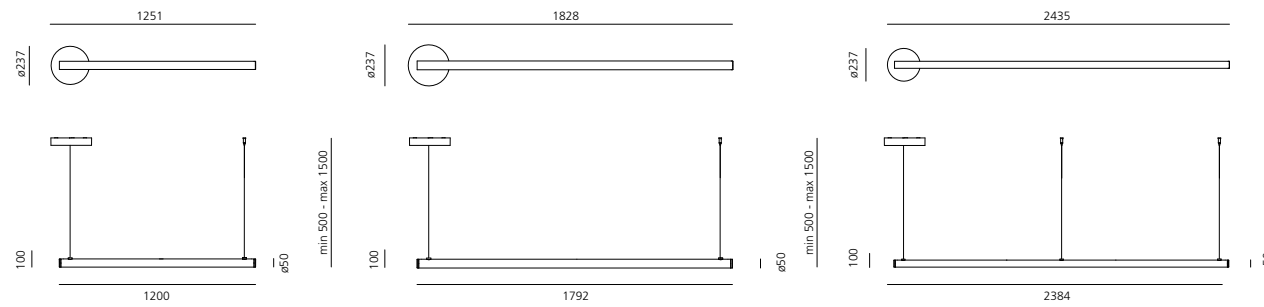
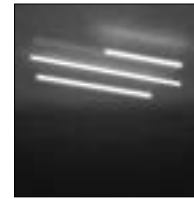

### CIRCULAR

	W	Flux	CCT	PUSH/DALI Code	PUSH & APP Code
Circular $\varnothing 90$	55 W	6040 lm	3000K	<b>1206000A</b>	<b>1206000APP</b>
Circular $\varnothing 155$	91W	10740 lm	3000K	<b>1207000A</b>	<b>1207000APP</b>

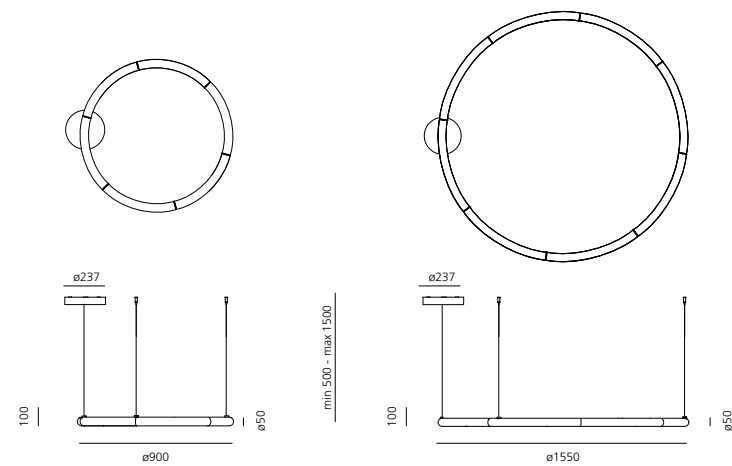

# Alphabet of light ↪ System



→ Patent pending for optics  
→ Patent pending for the mechanical and electrical connection



# Alphabet of light System configuration

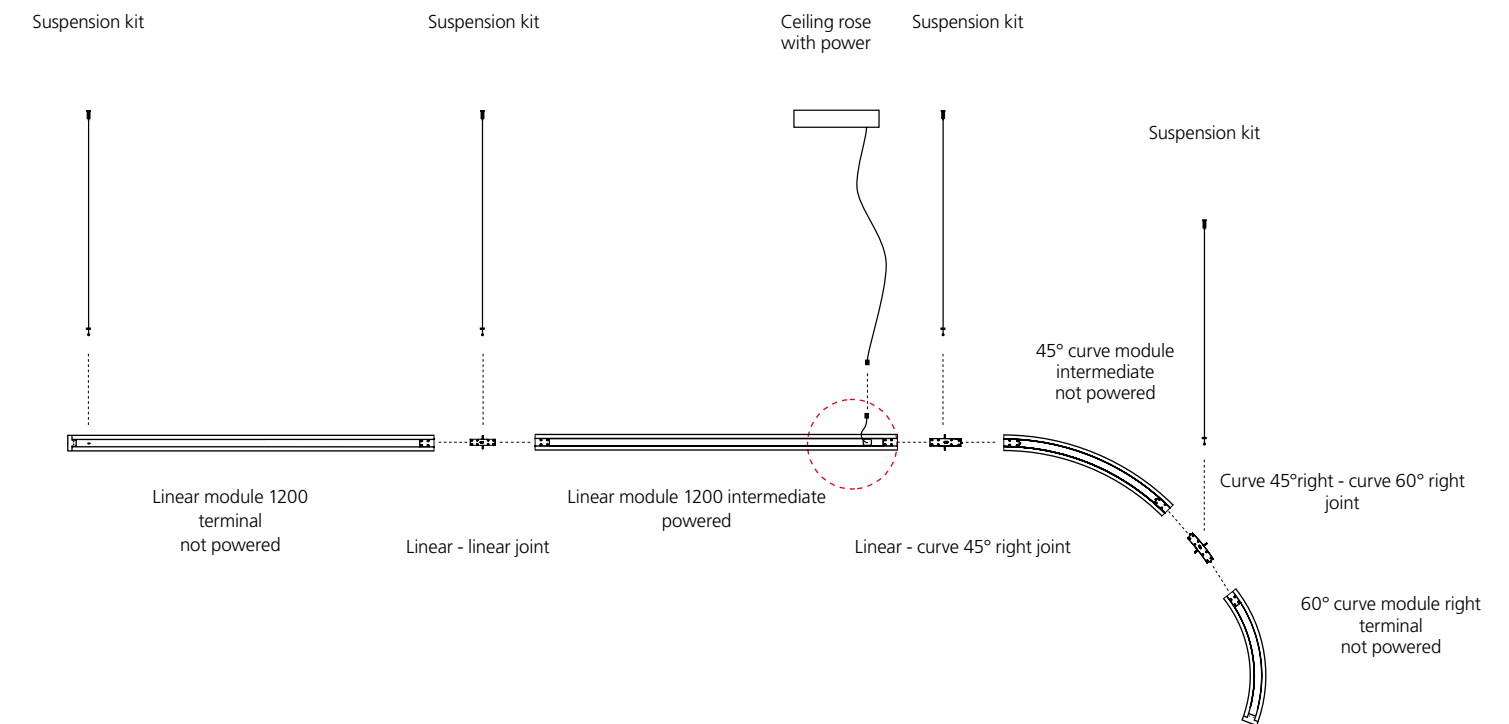
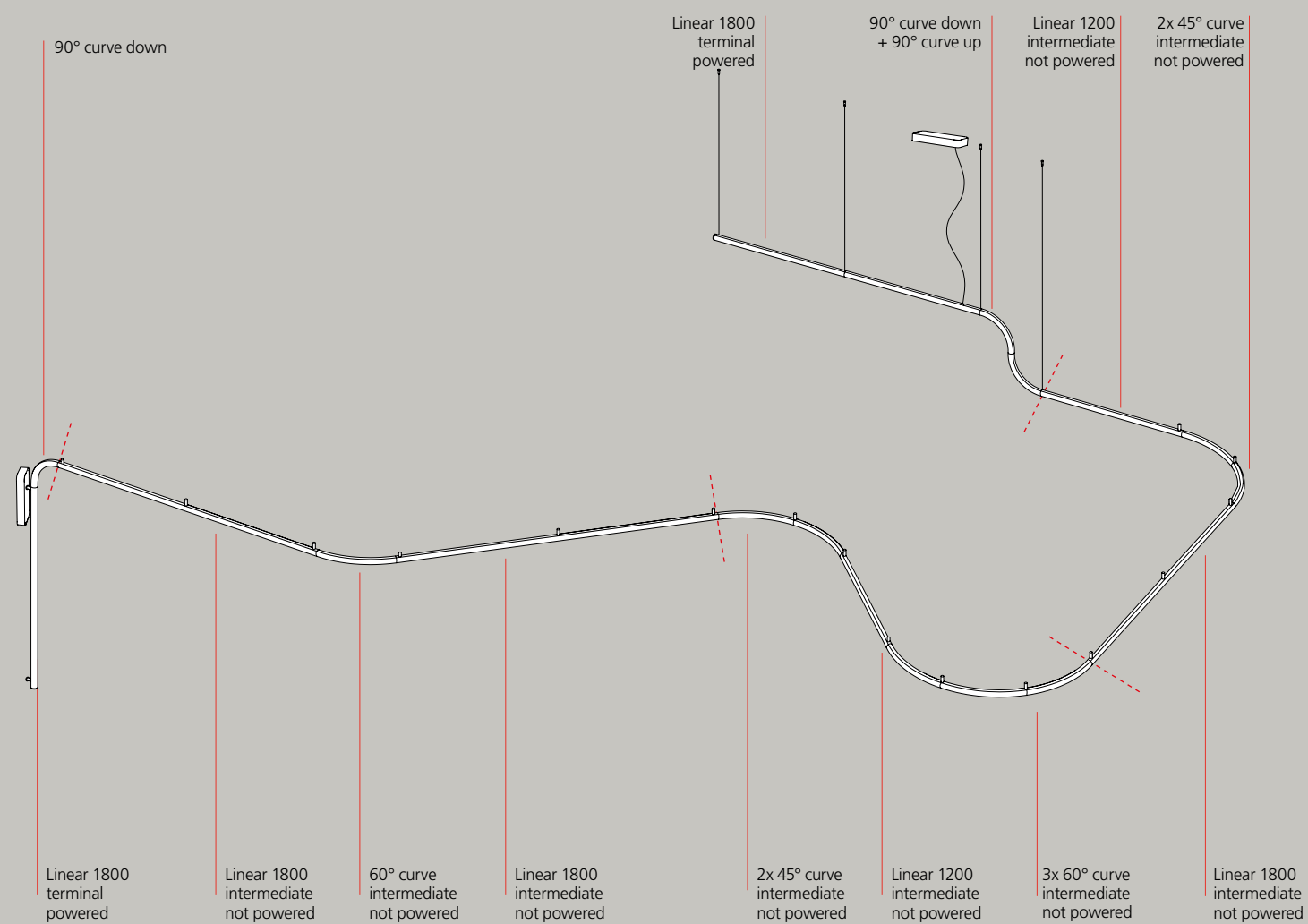

Materials: structure in anodized natural aluminium, tube in white diffusing PMMA

Linear module are available in three lengths: L 600 / 1200 / 1800 mm

Possibility to articulate the configuration on the horizontal plane with 45° and 60° curves and on the vertical plane with 90° curves.

Max 10 m for each power unit (10 m in one direction or 5 m in both directions)

Ceiling rose with power supply for each group.

DALI dimming possible for the entire system or for groups of modules powered by the same driver

# Suspension modules

## → LINEAR ELEMENTS

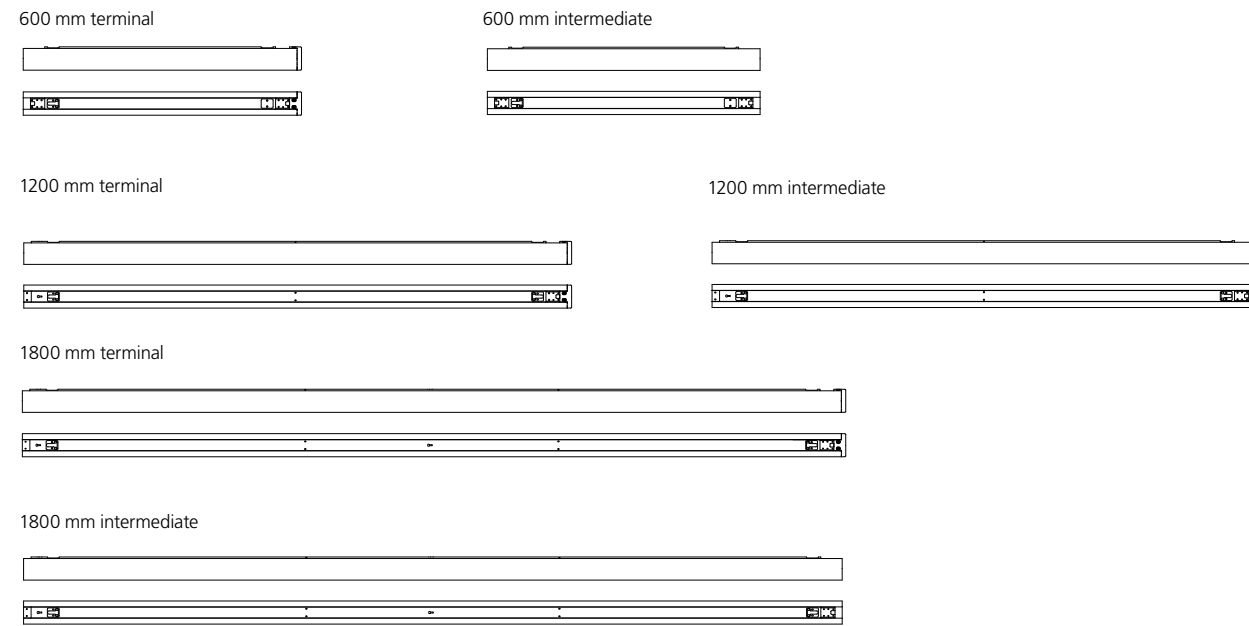

## → CURVED ELEMENTS

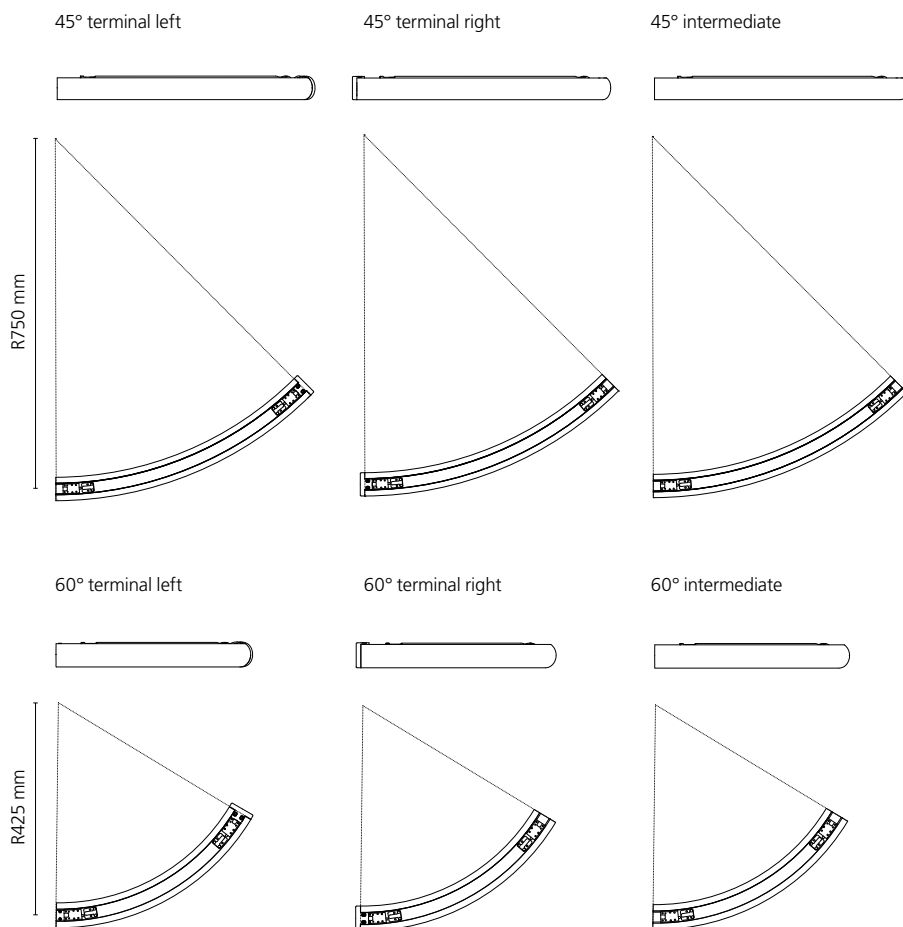

## → VERTICAL ELEMENTS

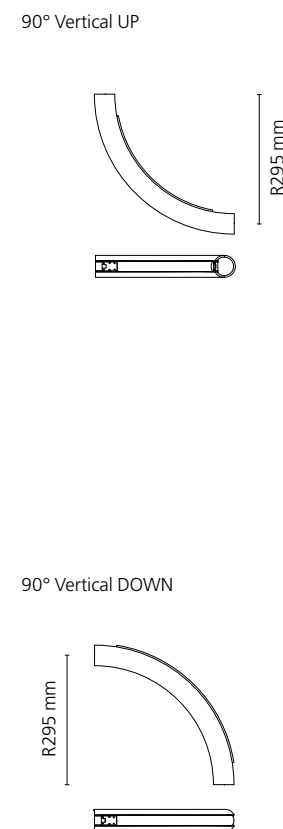

## ↪ ALPHABET OF LIGHT - SYSTEM

Opal White 	XF 	The APP driver can not be controlled by DALI dimming system and viceversa.	MacAdam 3SDCM Life L80 (12K) 72000h CRI =80	IP20 
----------------	--------	--	---	----------

### SUSPENSION LINEAR ELEMENTS

Length	W	V	Flux	CCT	Powered	Not powered
					Code	Code
600 mm terminal	11 W	24V	968 lm	3000K	2100010A	2101010A
					2100C10A	2101C10A
600 mm intermediate	11 W	24V	968 lm	3000K	2102010A	2102010A
					2105C10A	2102C10A
1200 mm terminal	22 W	24V	1936 lm	3000K	2104010A	2106010A
					2104C10A	2106C10A
1200 mm intermediate	22 W	24V	1936 lm	3000K	2105010A	2107010A
					2105C10A	2107C10A
1800 mm terminal	33 W	24V	2904 lm	3000K	2108010A	2110010A
					2108C10A	2110C10A
1800 mm intermediate	33 W	24V	2904 lm	3000K	2109010A	2111010A
					2109C10A	2111C10A

### SUSPENSION CURVED ELEMENTS

Length	W	V	Flux	CCT	Powered	Not powered
					Code	Code
45° terminal left	8 W	24V	968 lm	3000K	2112010A	2115010A
					2112C10A	2115C10A
45° terminal right	8 W	24V	968 lm	3000K	2113010A	2116010A
					2113C10A	2116C10A
45° intermediate	8 W	24V	968 lm	3000K	2114010A	2117010A
					2114C10A	2117C10A
60° terminal left	8 W	24V	728 lm	3000K	2118010A	2121010A
					2118C10A	2121C10A
60° terminal right	8 W	24V	728 lm	3000K	2119010A	2122010A
					2119C10A	2122C10A
60° intermediate	8 W	24V	728 lm	3000K	2120010A	2123010A
					2120C10A	2123C10A

### VERTICAL ELEMENTS

Length	W	V	Flux	CCT	Powered	Not powered
					Code	Code
90° vertical UP	8 W	24V	728 lm	3000K	2124010A	2124010A
					2124C10A	2124C10A
90° vertical DOWN	8 W	24V	728 lm	3000K	2125010A	2125010A
					2125C10A	2125C10A

### Accessories

	Joint n°	Code
Linear - linear joint	01	2250010A
Linear - curve 45° right joint	02	2251010A
Linear - curve 45° left joint	03	2252010A
45° curve - 45° curve joint	04	2255010A
Linear - curve 60° right joint	05	2253010A
Linear - curve 60° left joint	06	2254010A
60° curve - 60° curve joint	07	2256010A
60° curve - 45° curve S joint	08	2257010A
45° curve left - 45° curve left S joint	09	2260010A
60° curve left - 60° curve left S joint	10	2259010A
60°/45° curve left - 45°/60° curve right joint	11	2261010A
60°/45° curve right - 45°/60° curve left joint	12	2262010A
90° vertical UP - 90° vertical DOWN S joint	13	2263010A
Lineare - 90° vertical UP joint	14	2264010A
Linear - 90° vertical DOWN joint	15	2265010A
45° curve - 60° curve S joint	16	2258010A
60° curve right - 60° curve right joint	17	2269010A
45° curve right - 45° curve right joint	18	2270010A

### Rose



	Code
Rose / power	2267010A
Rose / power APP	2267010APP
Remote rose / power	2272010A
Remote rose / power APP	2272010APP

### Suspension accessories

	Code
Suspension kit L=1,50m	2266010A
Suspension kit L=4m	2273010A
Lengthening L=1,25m	2274010A
Lengthening L=2,50m	2275010A

## ALPHABET OF LIGHT - SYSTEM

# Wall/ceiling modules

Opal White 	XF 	The APP driver can not be controlled by DALI dimming system and viceversa.	MacAdam 3SDCM Life L80 (12K) 72000h CRI = 80	IP20 
---	---	--	--	---

### → LINEAR ELEMENTS

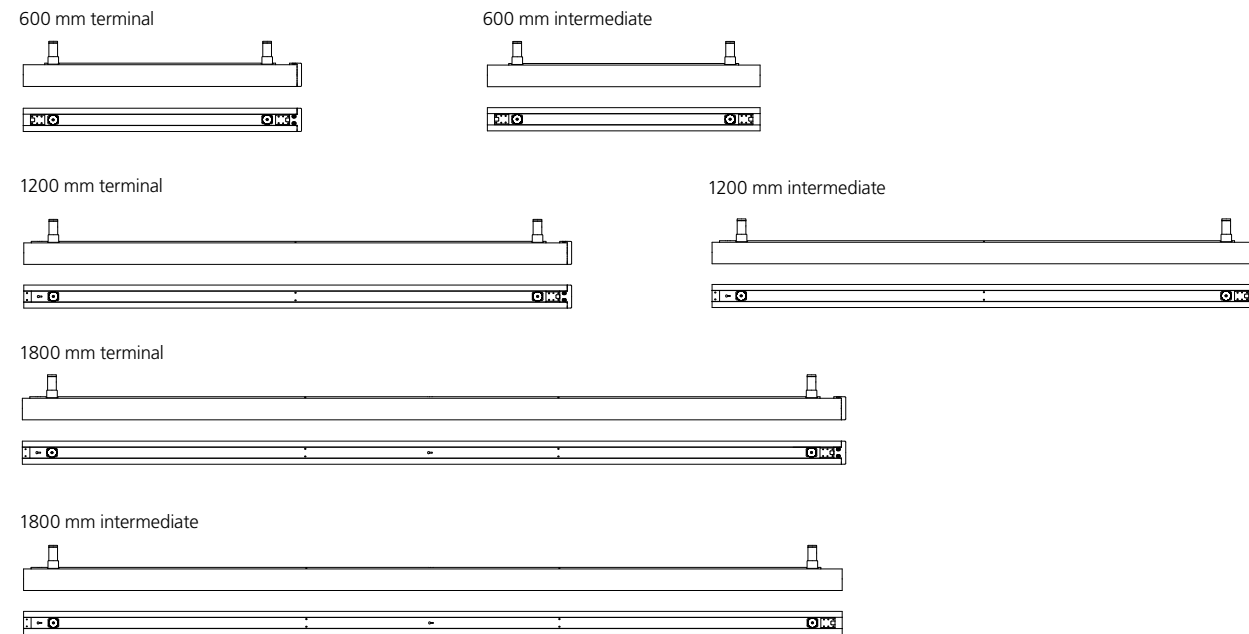

### WALL/CEILING LINEAR ELEMENTS

Length	W	V	Flux	CCT	Powered	Semi-recessed powered	Not powered
					Code	Code	Code
600 mm terminal	11 W	24V	968 lm	3000K	2130010A	2160010A	2131010A
					2130C10A	2160C10A	2131C10A
600 mm intermediate	11 W	24V	968 lm	3000K	3500K		2132010A
							2132C10A
1200 mm terminal	22 W	24V	1936 lm	3000K	2134010A	2161010A	2136010A
					2134C10A	2161C10A	2136C10A
1200 mm intermediate	22 W	24V	1936 lm	3000K	3500K		2135010A
							2135C10A
1800 mm terminal	33 W	24V	2904 lm	3000K	2138010A	2163010A	2140010A
					2138C10A	2163C10A	2140C10A
1800 mm intermediate	33 W	24V	2904 lm	3000K	3500K		2139010A
							2139C10A

### WALL/CEILING CURVED ELEMENTS

Length	W	V	Flux	CCT	Powered	Semi-recessed powered	Not powered
					Code	Code	Code
45° terminal left	8 W	24V	968 lm	3000K	2142010A	2165010A	2145010A
					2142C10A	2165C10A	2145C10A
45° terminal right	8 W	24V	968 lm	3000K	2143010A	2166010A	2146010A
					2143C10A	2166C10A	2146C10A
45° intermediate	8 W	24V	968 lm	3000K	3500K		2144010A
							2144C10A
60° terminal left	8 W	24V	728 lm	3000K	2148010A	2168010A	2151010A
					2148C10A	2168C10A	2151C10A
60° terminal right	8 W	24V	728 lm	3000K	2149010A	2169010A	2152010A
					2149C10A	2169C10A	2152C10A
60° intermediate	8 W	24V	728 lm	3000K	3500K		2150010A
							2150C10A

### VERTICAL ELEMENTS

Length	W	V	Flux	CCT	Powered	Not powered
90° vertical UP	8 W	24V	728 lm	3000K	2150010A	2124010A
					2150C10A	2124C10A
90° vertical DOWN	8 W	24V	728 lm	3000K	2150010A	2125010A
					2150C10A	2125C10A

### Accessories

	Joint n°	Code
Linear - linear joint	01	2250010A
Linear - curve 45° right joint	02	2251010A
Linear - curve 45° left joint	03	2252010A
45° curve - 45° curve joint	04	2255010A
Linear - curve 60° right joint	05	2253010A
Linear - curve 60° left joint	06	2254010A
60° curve - 60° curve joint	07	2256010A
60° curve - 45° curve S joint	08	2257010A
45° curve left - 45° curve left S joint	09	2260010A
60° curve left - 60° curve left S joint	10	2259010A
60°/45° curve left - 45°/60° curve right joint	11	2261010A
60°/45° curve right - 45°/60° curve left joint	12	2262010A
90° vertical UP - 90° vertical DOWN S joint	13	2263010A
Lineare - 90° vertical UP joint	14	2264010A
Linear - 90° vertical DOWN joint	15	2265010A
45° curve - 60° curve S joint	16	2258010A
60° curve right - 60° curve right joint	17	2269010A
45° curve right - 45° curve right joint	18	2270010A

### Wall/Ceiling accessories

	Code
Rose / power	2268010A
Rose / power APP	2268010APP
Driver for recessed version (240W, 220-240 VAC, IP67, L240 X W67 X H35, DALI)	2271010A
BLL MODULE for APP management in the recessed version	2271010APP

### → CURVED ELEMENTS

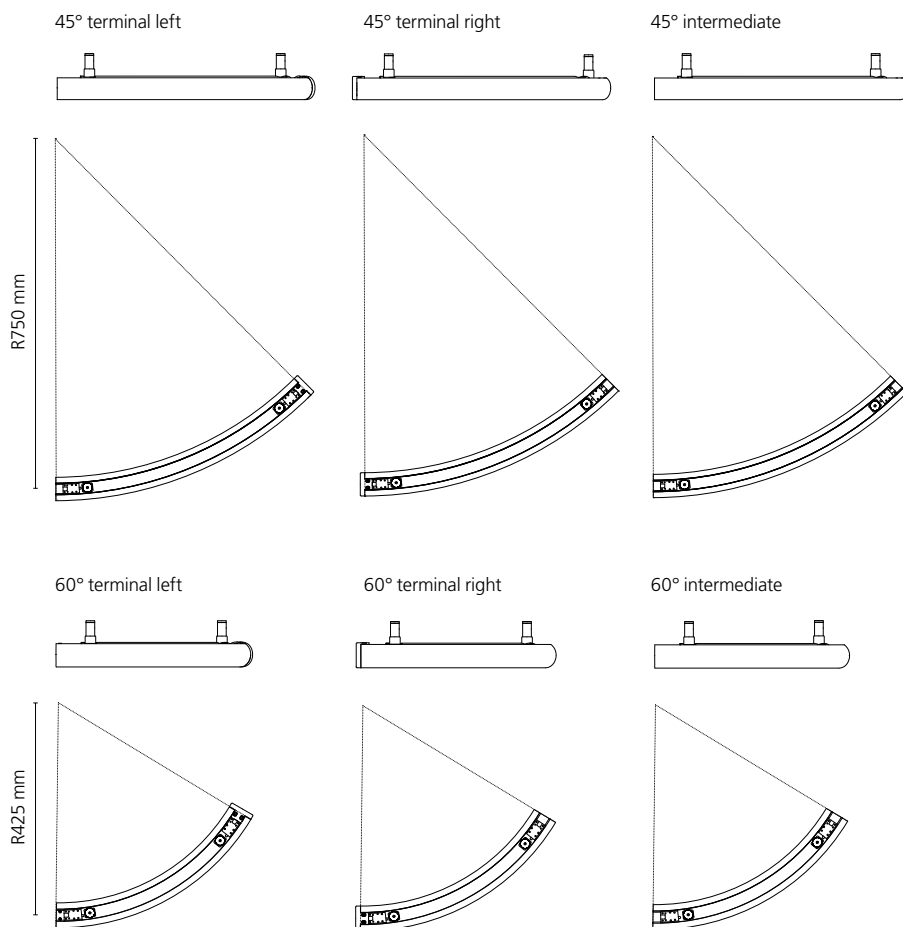

### → VERTICAL ELEMENTS

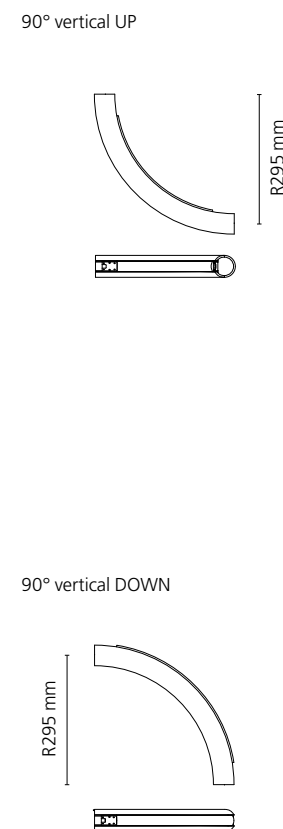



# Joints

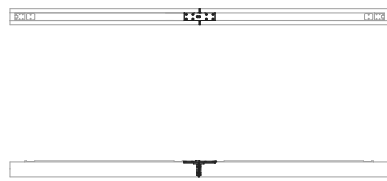

01. Code 2250010A  
LINEAR - LINEAR JOINT

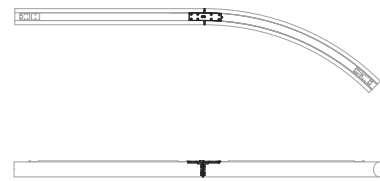

02. Code 2251010A  
LINEAR -  
CURVE 45° RIGHT JOINT

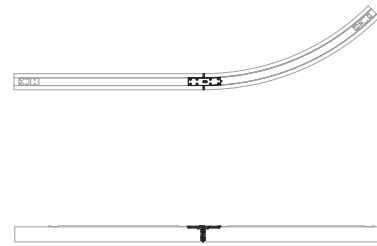

03. Code 2252010A  
LINEAR -  
CURVE 45° LEFT JOINT

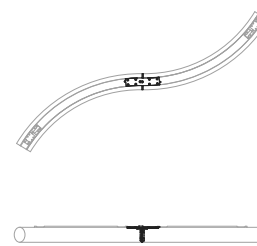

10. Code 2259010A  
60° CURVE LEFT -  
60° CURVE LEFT S JOINT

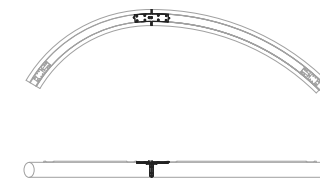

11. Code 2261010A  
60°/45° CURVE LEFT -  
45°/60° CURVE RIGHT JOINT

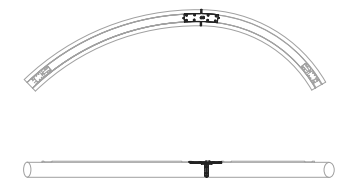

12. Code 2262010A  
60°/45° CURVE RIGHT -  
45°/60° CURVE LEFT JOINT

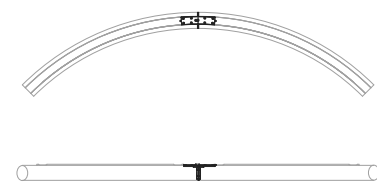

04. Code 2255010A  
45° CURVE -  
45° CURVE JOINT

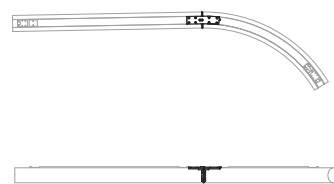

05. Code 2253010A  
LINEAR -  
CURVE 60° RIGHT JOINT

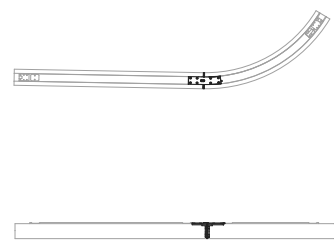

06. Code 2254010A  
LINEAR -  
CURVE 60° LEFT JOINT

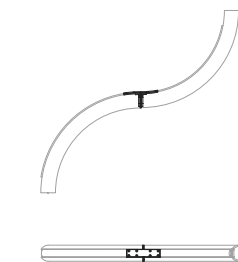

13. Code 2263010A  
90° VERTICAL UP -  
90° VERTICAL DOWN S JOINT

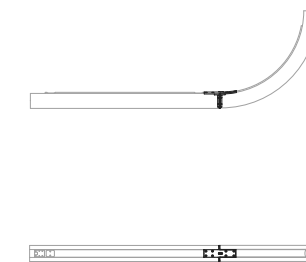

14. Code 2264010A  
LINEAR -  
90° VERTICAL UP JOINT

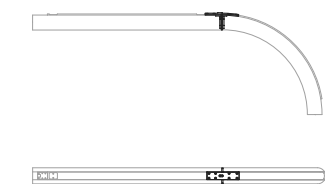

15. Code 2265010A  
LINEAR -  
90° VERTICAL DOWN JOINT

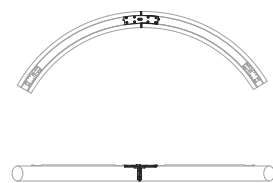

07. Code 2256010A  
60° CURVE -  
60° CURVE JOINT

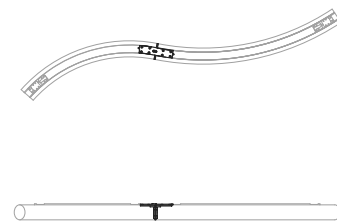

08. Code 2257010A  
60° CURVE -  
45° CURVE S JOINT

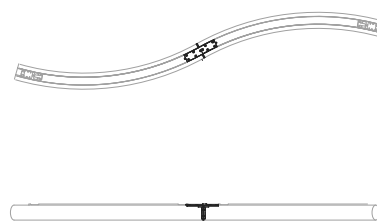

09. Code 2260010A  
45° CURVE LEFT -  
45° CURVE LEFT S JOINT

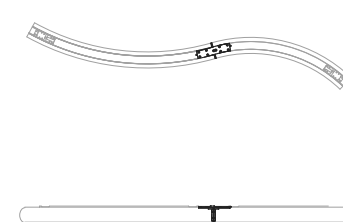

16. Code 2258010A  
45° CURVE -  
60° CURVE S JOINT

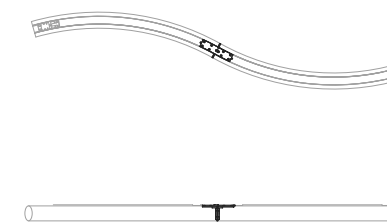

17. Code 2269010A  
60° CURVE RIGHT -  
60° CURVE RIGHT JOINT

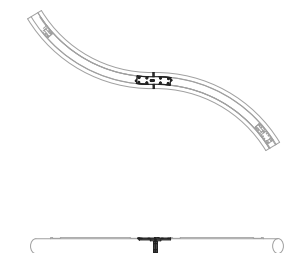

18. Code 227010A  
45° CURVE RIGHT -  
45° CURVE RIGHT JOINT

# Alphabet of light ↪ Letters







# Alphabet of light Letters installation

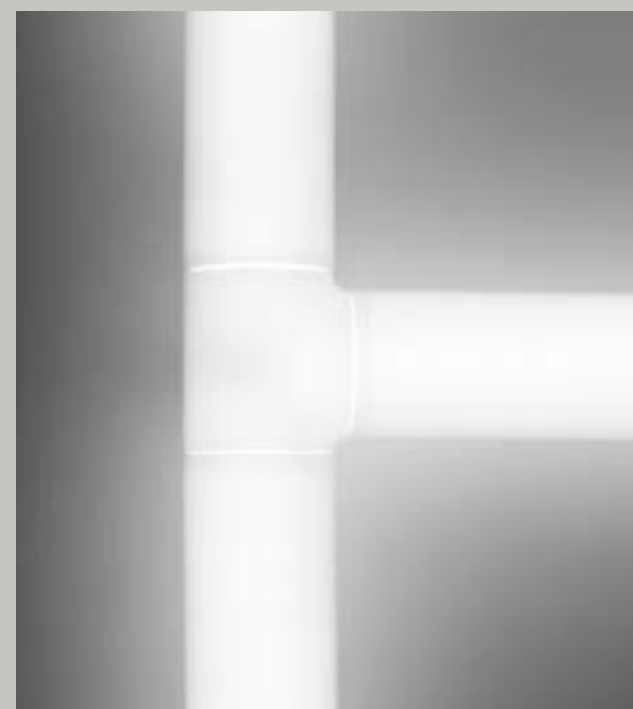
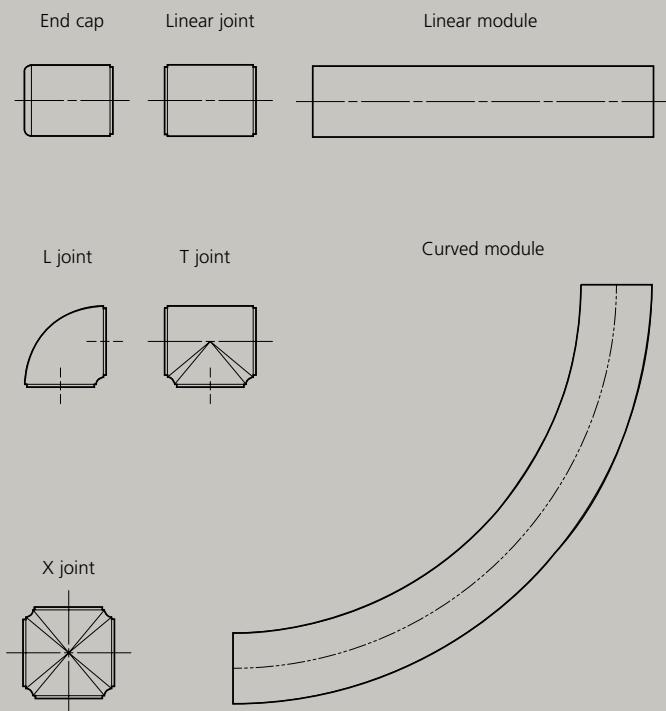

## Modules

An entire alphabet composed by 7 elements:  
5 joints + 2 constructive modules  
with electro mechanical connections

## → MDF SUPPORT INSTALLATION

The letters are provided mounted on MDF panels to allow installation on any kind of wall. Installation requires creating a counter-frame to accommodate the drivers, supplied separately, and the power cables. A configuration software is available to calculate the necessary usable surface, as well as to identify the codes required to implement the desired project.

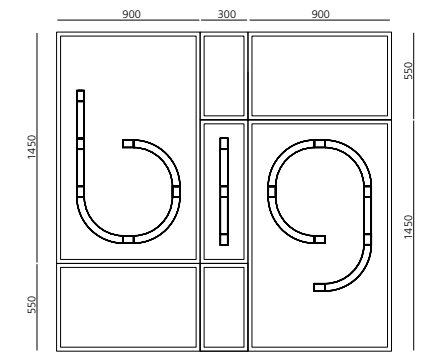

1. Create the supporting frame and provide for power connections for the individual letters.



2. Connect panel b to power source.



3. Fix panel l and connect panel l to power source.



4. Fix panel i and connect panel g to power source.



5. Fix panel g and close using the supplied panels.



6. Complete closing using the supplied panels.



7. Frame ready for finishing.



8. Apply the gauze and plaster flush with the gaps between panels.



9. Final painting.

→ CARDBOARD MOUNTING-SUPPORT INSTALLATION

The letters are provided with a packaging that ensures the right support during the installation process. This type of installation is suitable for existing drywalls that have accessible back space for the housing of drivers (code DV1009) supplied separately and cables (power supply 75 W max - 2 letters or more up to max 85% load).

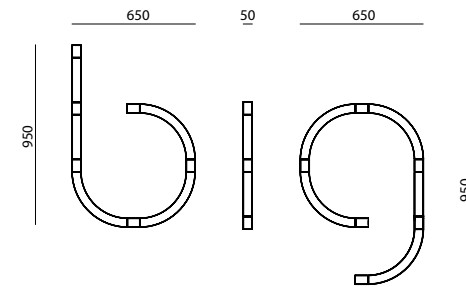

7. Detail of the wall pins fixing.



8. Removal of the nylon wrapper.



9. Removal of the cardboard support.



1. Drywall with accessible back space.



2. Use the provided template to drill the holes and paint the drywall.



3. Install wall pins, identify output points and prepare wiring connections.



10. Connect letter I to first wall output.



11. Fix letter I on wall pins.



12. Removal of the nylon wrapper.

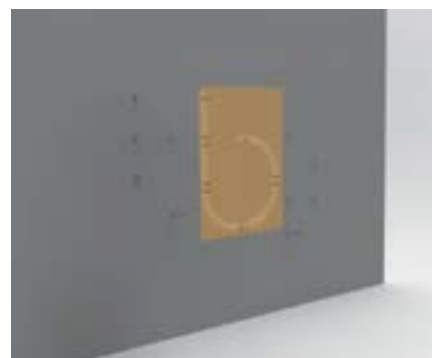

4. Connection of letter b to first wall output.



5. Attachment of letter b on wall pins.



6. Detail of the wall pins fixing.



13. Attachment of letter g to first wall output.



14. Removal of the nylon wrapper.



15. Finished.

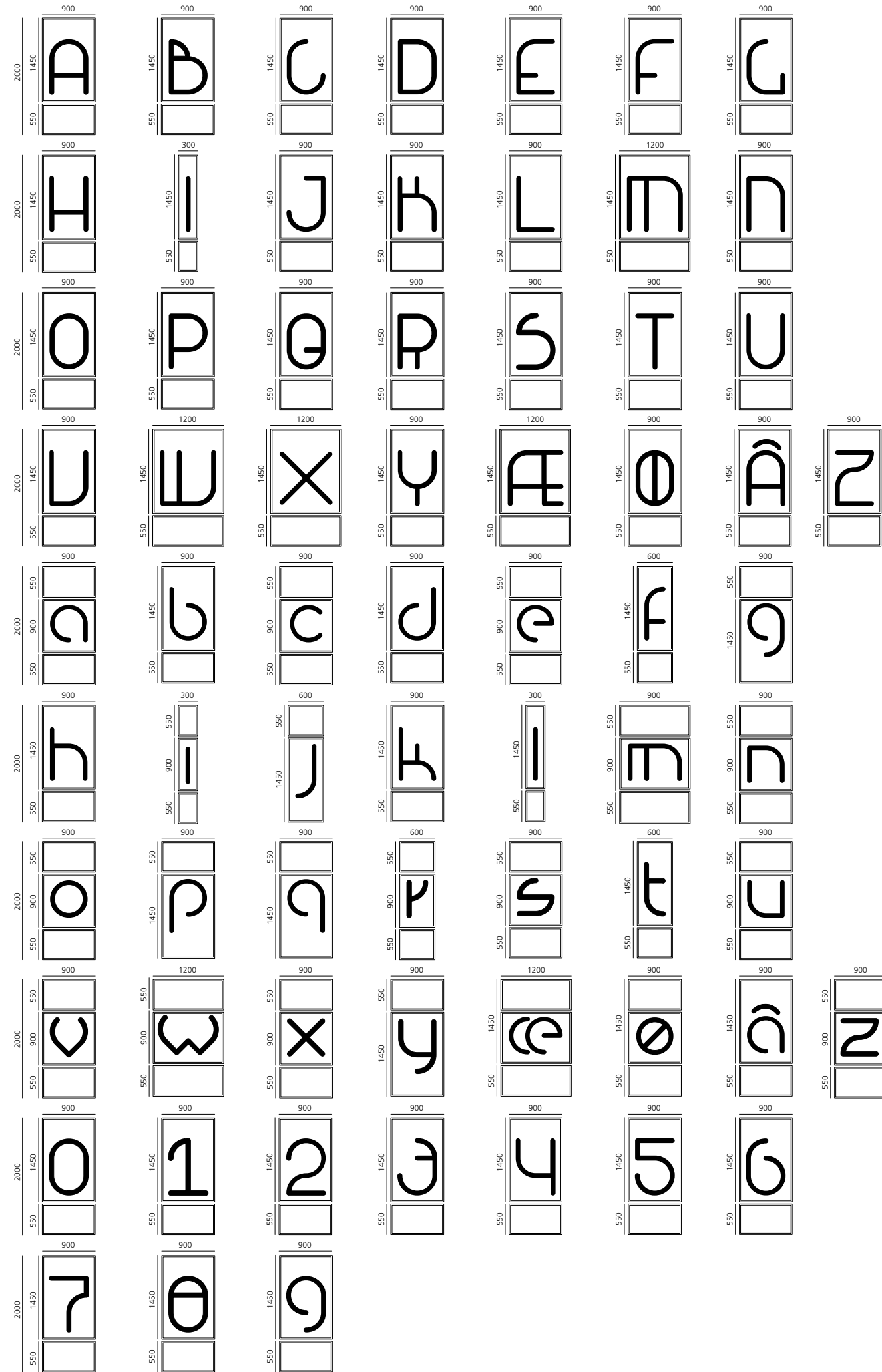

## ↪ ALPHABET OF LIGHT - LETTERS

Opal White  XF

Driver supplied separately.

MacAdam 3SDCM  
Life L80 (10K) 55000h  
CRI = 80

IP20

Uppercase	Size			Dimmable DALI	
Letter	W	Flux	H x L	Letters	+ Support
A	30 W	2300lm	950 x 650	1201A00A	1211A00A
B	31 W	2450lm	950 x 650	1201B00A	1211B00A
C	20 W	1450lm	950 x 650	1201C00A	1211C00A
D	29 W	2300lm	950 x 650	1201D00A	1211D00A
E	26 W	1900lm	950 x 650	1201E00A	1211E00A
F	19 W	1400lm	950 x 650	1201F00A	1211F00A
G	21 W	1050lm	950 x 650	1201G00A	1211G00A
H	27 W	3200lm	950 x 650	1201H00A	1211H00A
I	11 W	750lm	950 x 50	1201I00A	1211I00A
J	21 W	1550lm	950 x 650	1201J00A	1211J00A
K	26 W	1900lm	950 x 650	1201K00A	1211K00A
L	17 W	2450lm	950 x 650	1201L00A	1211L00A
M	38 W	2900lm	950 x 950	1201M00A	1211M00A
N	25 W	1900lm	950 x 650	1201N00A	1211N00A
O	27 W	2100lm	950 x 650	1201O00A	1211O00A
P	27 W	2300lm	950 x 650	1201P00A	1211P00A
Q	31 W	3000lm	950 x 650	1201Q00A	1211Q00A
R	30 W	2300lm	950 x 650	1201R00A	1211R00A
S	23 W	1700lm	950 x 650	1201S00A	1211S00A
T	17 W	2050lm	950 x 650	1201T00A	1211T00A
U	24 W	1800lm	950 x 650	1201U00A	1211U00A
V	25 W	1900lm	950 x 650	1201V00A	1211V00A
W	38 W	1990lm	950 x 950	1201W00A	1211W00A
X	27 W	2000lm	950 x 900	1201X00A	1211X00A
Y	21 W	1550lm	950 x 650	1201Y00A	1211Y00A
Z	27 W	2000lm	950 x 650	1201Z00A	1211Z00A

Numbers	Size			Dimmable DALI	
Letter	W	Flux	H x L	Letters	+ Support
0	27 W	2100lm	950 x 650	1200000A	1210000A
1	23 W	1650lm	950 x 650	1200100A	1210100A
2	28 W	2100lm	950 x 650	1200200A	1210200A
3	24 W	1700lm	950 x 650	1200300A	1210300A
4	23 W	1650lm	950 x 650	1200400A	1210400A
5	29 W	2200lm	950 x 650	1200500A	1210500A
6	25 W	1850lm	950 x 650	1200600A	1210600A
7	19 W	1400lm	950 x 650	1200700A	1210700A
8	33 W	2600lm	950 x 650	1200800A	1210800A
9	25 W	1850lm	950 x 650	1200900A	1210900A

Lowercase	Size			Dimmable DALI	
Letter	W	Flux	H x L	Letters	+ Support
a	20 W	1450lm	650 x 650	1202a00A	1212a00A
b	23 W	1700lm	950 x 650	1202b00A	1212b00A
c	17 W	1200lm	650 x 650	1202c00A	1212c00A
d	23 W	1700lm	950 x 650	1202d00A	1212d00A
e	20 W	1450lm	650 x 650	1202e00A	1212e00A
f	16 W	1150lm	950 x 350	1202f00A	1212f00A
g	25 W	1850lm	950 x 650	1202g00A	1212g00A
h	23 W	1650lm	950 x 650	1202h00A	1212h00A
i	8 W	500lm	650 x 50	1202i00A	1212i00A
j	13 W	900lm	950 x 350	1202j00A	1212j00A
k	23 W	1650lm	950 x 650	1202k00A	1212k00A
l	11 W	750lm	950 x 50	1202l00A	1212l00A
m	29 W	2150lm	650 x 950	1202m00A	1212m00A
n	19 W	1400lm	650 x 650	1202n00A	1212n00A
o	21 W	1600lm	650 x 650	1202o00A	1212o00A
p	23 W	1700lm	950 x 650	1202p00A	1212p00A
q	23 W	1700lm	950 x 650	1202q00A	1212q00A
r	14 W	900lm	650 x 350	1202r00A	1212r00A
s	21 W	1550lm	650 x 650	1202s00A	1212s00A
t	17 W	1150lm	950 x 350	1202t00A	1212t00A
u	19 W	1400lm	650 x 650	1202u00A	1212u00A
v	18 W	1300lm	650 x 650	1202v00A	1212v00A
w	24 W	1800lm	650 x 950	1202w00A	1212w00A
x	15 W	1000lm	650 x 650	1202x00A	1212x00A
y	25 W	1800lm	950 x 650	1202y00A	1212y00A
æ	32 W	2250lm	650 x 950	1202æ00A	1212æ00A
ø	27 W	2100lm	650 x 650	1202ø00A	1212ø00A
ñ	25 W	1850lm	650 x 650	1202ñ00A	1212ñ00A
z	24 W	1800lm	650 x 650	1202z00A	1212z00A

Driver							
Driver	Vac	L <sub>mm</sub>	W <sub>mm</sub>	H <sub>mm</sub>	IP	N° device	Code
75 W	220-240	180	52	30	20	1min-2max	Undimmable DV1009

# Discovery

Ernesto Gismondi  
↪ 2015



reddot design award  
2017



For further information on Discovery  
↪ visit [artemide.com](http://artemide.com)





**Discovery  
is visible**

**is invisible**



Ph. Pierpaolo Ferreri 2014





## Discovery wall



Light OFF



Light ON

# Discovery typologies

## SUSPENSION HORIZONTAL



An ultra-light aluminum profile hosts a LED strip that injects light into a technopolymer surface with microengravings. The microengravings pattern ensures maximum efficiency and uniformity in direct and indirect emission. Dimmable devices (push dimmer). Available as suspension and wall/ceiling Ø 700 mm, as vertical suspension Ø 700-1000-1400 mm.

### DISCOVERY



XF  
(>45°)  
40 W  
2857 lm



Artemide  
App

## SUSPENSION VERTICAL

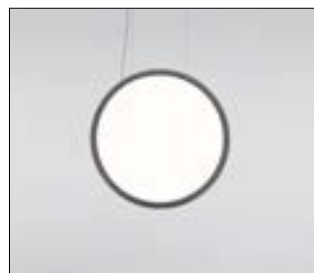

DISCOVERY VERTICAL Ø700 / TW / RGBW

DISCOVERY VERTICAL Ø1000 / TW / RGBW

DISCOVERY VERTICAL Ø1400

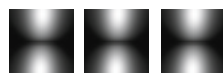

XF TW RGBW  
(>45°) (>45°) (>45°)  
40 W 95 W 46 W  
2857 lm 5020 lm 1705 lm



XF TW RGBW  
(>45°) (>45°) (>45°)  
63 W 136 W 66 W  
3195 lm 7171 lm 2440 lm



XF  
(>45°)  
89 W  
4500 lm

## WALL



### DISCOVERY WALL



XF  
(>45°)  
40 W  
2857 lm



### UGR<19

Uniform and diffuse light suitable for workplaces

High-end and innovative technology

Maximum efficiency and uniformity

Perfectly transparent surface

Extracting light

## DISCOVERY

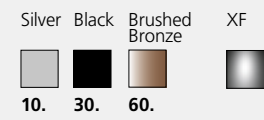

The APP driver can not be controlled by DALI dimming system and viceversa.

MacAdam 3SDCM  
Life L90 (6K) 50000h  
CRI =90

IP20

### DISCOVERY WALL

W	Beam	Flux	CCT	PUSH Code
40 W	XF	2857 lm	3000K	<b>199801.10/30/60.A</b>

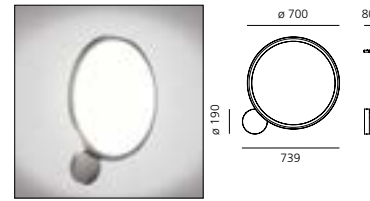

### DISCOVERY

W	Beam	Flux	CCT	PUSH Code	PUSH & APP Code
40 W	XF	2857 lm	3000K	<b>19991.10/30/60.A</b>	<b>19991.10/30/60.APP</b>

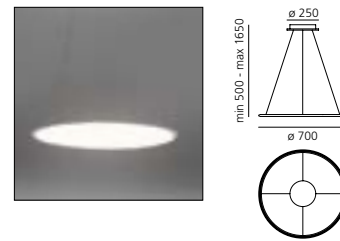

## DISCOVERY VERTICAL

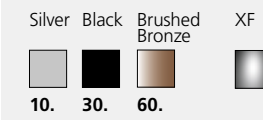

The APP driver can not be controlled by DALI dimming system and viceversa.

MacAdam 3SDCM  
Life L90 (6K) 50000h  
CRI =90

IP20

### DISCOVERY VERTICAL SUSPENSION

Ø	W	Beam	Flux	CCT	PUSH/DALI Code	PUSH & APP Code
700 mm	40 W	XF	2857 lm	3000K	<b>19920.10/30/60.A</b>	<b>19920.10/30/60.APP</b>
1000 mm	63 W	XF	3195 lm	3000K	<b>19930.10/30/60.A</b>	<b>19930.10/30/60.APP</b>
1400 mm	89 W	XF	4500 lm	3000K	<b>19940.10/30/60.A</b>	<b>19940.10/30/60.APP</b>

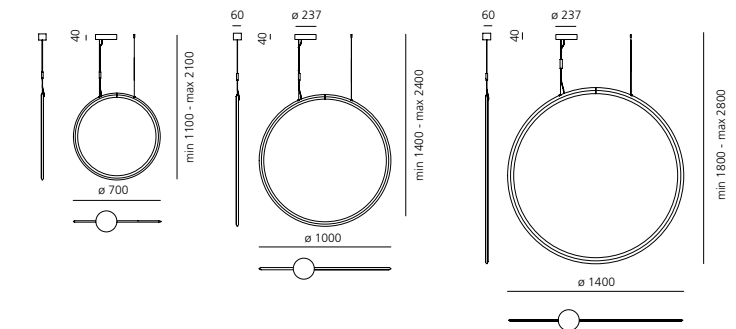
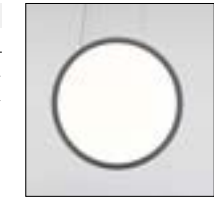

### DISCOVERY VERTICAL SUSPENSION TW

**TW**<sup>®</sup>  
Artemide Tunable White

Ø	W	Beam	Flux	CCT	DALI DT8 Code	APP Code
700 mm	95 W	XF	5020 lm	2700K-6500K	<b>19922.10/30/60.A</b>	<b>19922.10/30/60.APP</b>
1000 mm	136 W	XF	7171 lm	2700K-6500K	<b>19932.10/30/60.A</b>	<b>19932.10/30/60.APP</b>



### DISCOVERY VERTICAL SUSPENSION RGBW

Ø	W	Beam	Flux	DALI Code	APP Code
700 mm	46 W	XF	RGB 651 lm White 1054 lm	<b>19923.10/30/60.A</b>	<b>19923.10/30/60.APP</b>
1000 mm	66 W	XF	RGB 930 lm White 1510 lm	<b>19933.10/30/60.A</b>	<b>19933.10/30/60.APP</b>

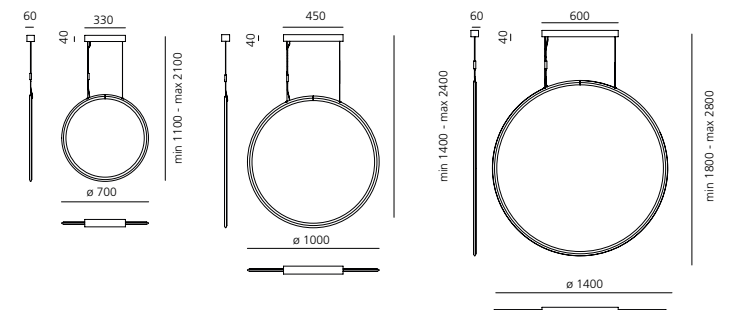

# Discovery Space

Ernesto Gismondi

↳ 2019





## DISCOVERY SPACE

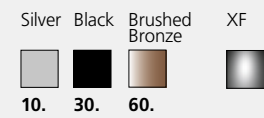

The APP driver can not be controlled by DALI dimming system and viceversa.

MacAdam 3SDCM  
Life L90 (6K) 50000h  
CRI =90

IP20

### DISCOVERY SPACE SQUARE

W	Beam	Flux	CCT
32 W	XF	2160 lm	3000K

**PUSH/DALI**  
Code  
**20040.10/30/60.A**

**PUSH & APP**  
Code  
**20040.10/30/60.APP**

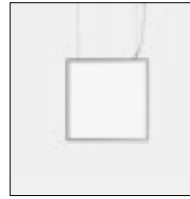

### DISCOVERY SPACE SQUARE TW

**TW**<sup>®</sup>  
Artemide Tunable White

W	Beam	Flux	CCT
78 W	XF	4085 lm	2700K-6500K

**DALI DT8**  
Code  
**20000.10/30/60.A**

**APP**  
Code  
**20000.10/30/60.APP**

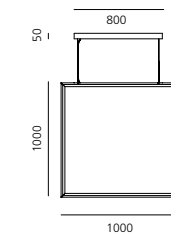

### DISCOVERY SPACE SQUARE RGBW

W	Beam	Flux
78 W	XF	RGB 592 lm White 960 lm

**DALI**  
Code  
**20010.10/30/60.A**

**APP**  
Code  
**20010.10/30/60.APP**

### DISCOVERY SPACE RECTANGULAR

W	Beam	Flux	CCT
53 W	XF	3600 lm	3000K

**PUSH/DALI**  
Code  
**20050.10/30/60.A**

**PUSH & APP**  
Code  
**20050.10/30/60.APP**

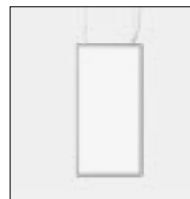

### DISCOVERY SPACE RECTANGULAR TW

**TW**<sup>®</sup>  
Artemide Tunable White

W	Beam	Flux	CCT
130 W	XF	6850 lm	2700K-6500K

**DALI DT8**  
Code  
**20020.10/30/60.A**

**APP**  
Code  
**20020.10/30/60.APP**

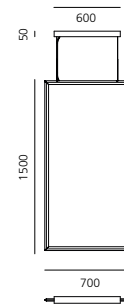

### DISCOVERY SPACE RECTANGULAR RGBW

W	Beam	Flux
130 W	XF	RGB 888 lm White 1440 lm

**DALI**  
Code  
**20030.10/30/60.A**

**APP**  
Code  
**20030.10/30/60.APP**

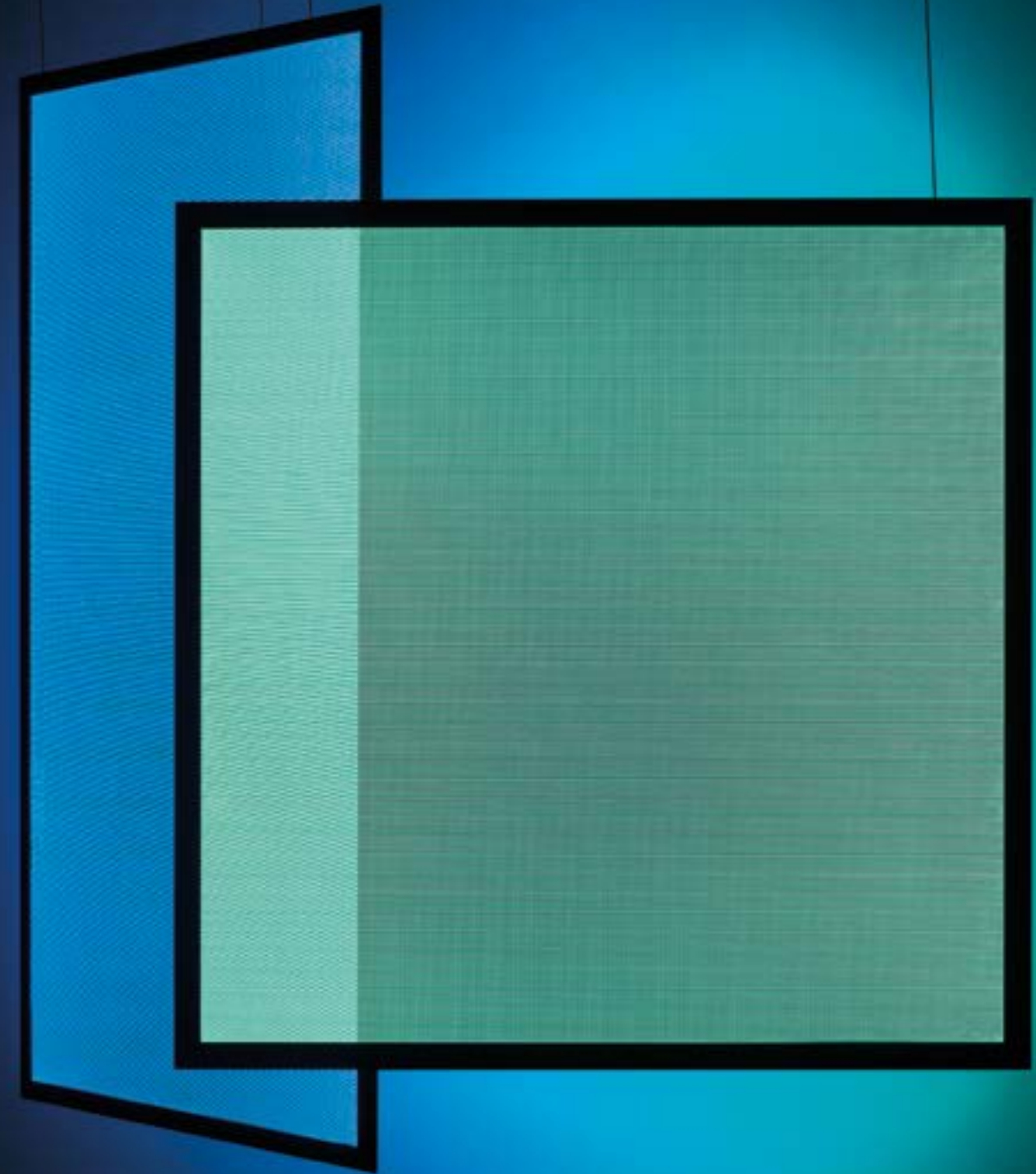

# Ameluna

Mercedes-Benz Style  
↷ 2016

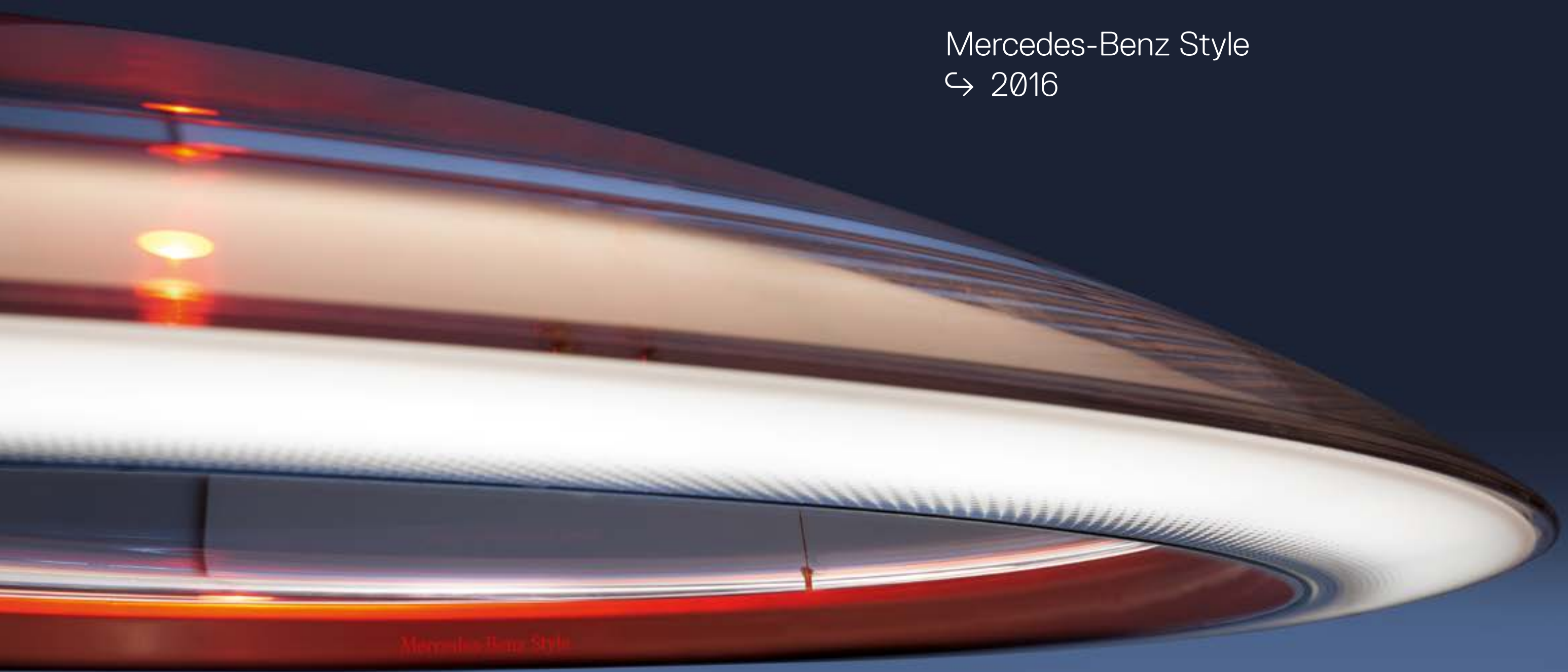

Mercedes-Benz Style

→ Patent pending

"Mercedes-Benz" and the styling of Ameluna are intellectual property of Daimler AG. They are used by Artemide S.p.A under license.

Artemide

Mercedes-Benz Style

A BRIGHT FUTURE



→ Ameluna discloses an innovative optoelectronic system integrated in the transparent frame. An aluminium band, a patent of innovation, which is welded with the optics, supports the led strip. The latter is also hidden behind the lower profile, in order to maintain the purity of the form. The transparent body allows the light to be both direct and partially refracted.



For further information on Ameluna  
→ visit [artemide.com](http://artemide.com)



Artemide  
App

The geometric section and the optical features of the materials give life to a "light box" that ensures perfect control of the emission, despite transparency.

A set of LED sources is installed along the lower profile, on a ring made of a thermo-conductive polymer, an innovative material that allows excellent heat dissipation.

Emission is perfectly designed through careful selection of the materials constituting the "light box". The special reflectance and transmittance properties, combined with a very low absorption coefficient, ensure that the light reflected from the inner surfaces of the section is scattered across the environment in a controlled and mostly direct way.

Ameluna can be controlled with an On/Off switch or using a Push to adjust its luminous intensity.

Ameluna RGB can be controlled using 2 different Push (one for white light and one for the RGB spotlight) and the Ameluna App. Control via push button has always priority over control with the App (when the Push are operated, the commands sent via bluetooth from the smartphone or tablet are ignored)..

## Ameluna white



Transparent Body

Reflective Ring

Heat-Sink Ring

Diffusing Ring

Ameluna RGB

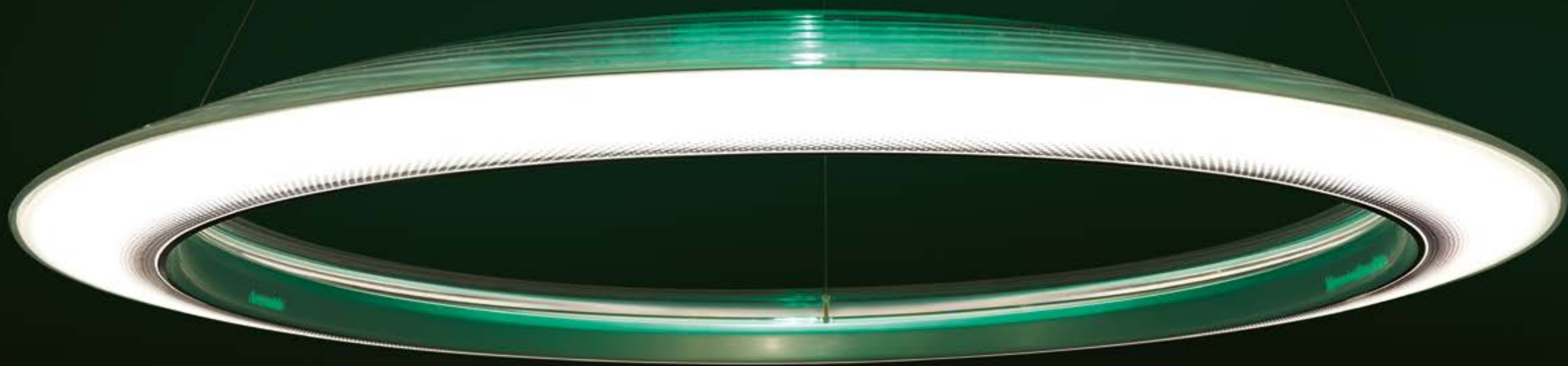

# Ameluna RGB



↪ AMELUNA

XF



The APP driver can not be controlled by DALI dimming system and viceversa.

MacAdam 3SDCM  
Life L70 (6K) 50000h  
CRI =90 (typ.)

IP20  
⊕  
EAC

WHITE

				PUSH/DALI	PUSH & APP
W	Beam	Flux	CCT	Code	Code
41 W	58°	3276 lm	3000 K	<b>1401010A</b>	<b>1401010APP</b>

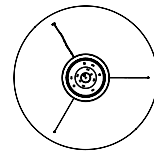
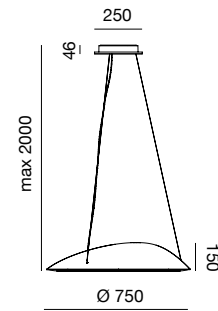

WHITE + SPOT RGB

W	Beam	Flux	CCT	Code
45 W	58°	3414 lm	RGB APP	<b>1402010APP</b>

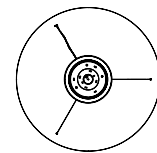
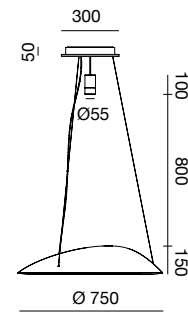

# Tagora

S. & R. Cornelissen

↪ 2008

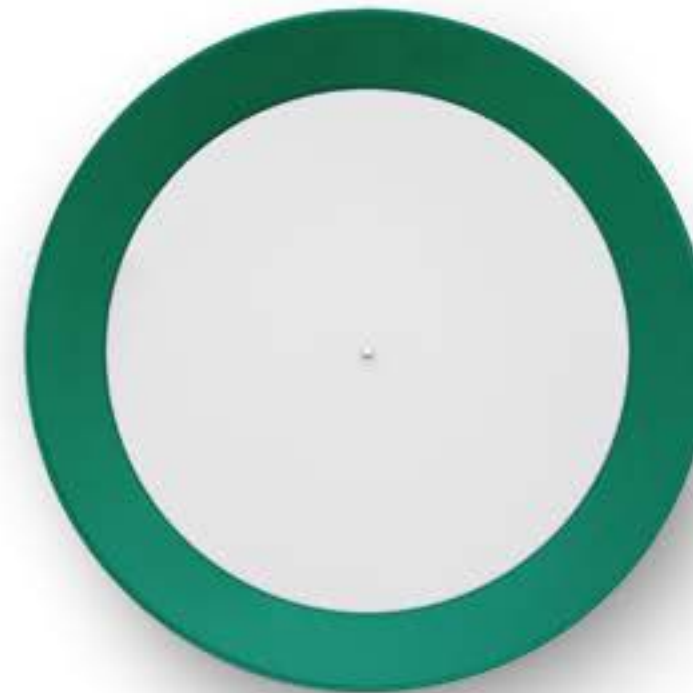
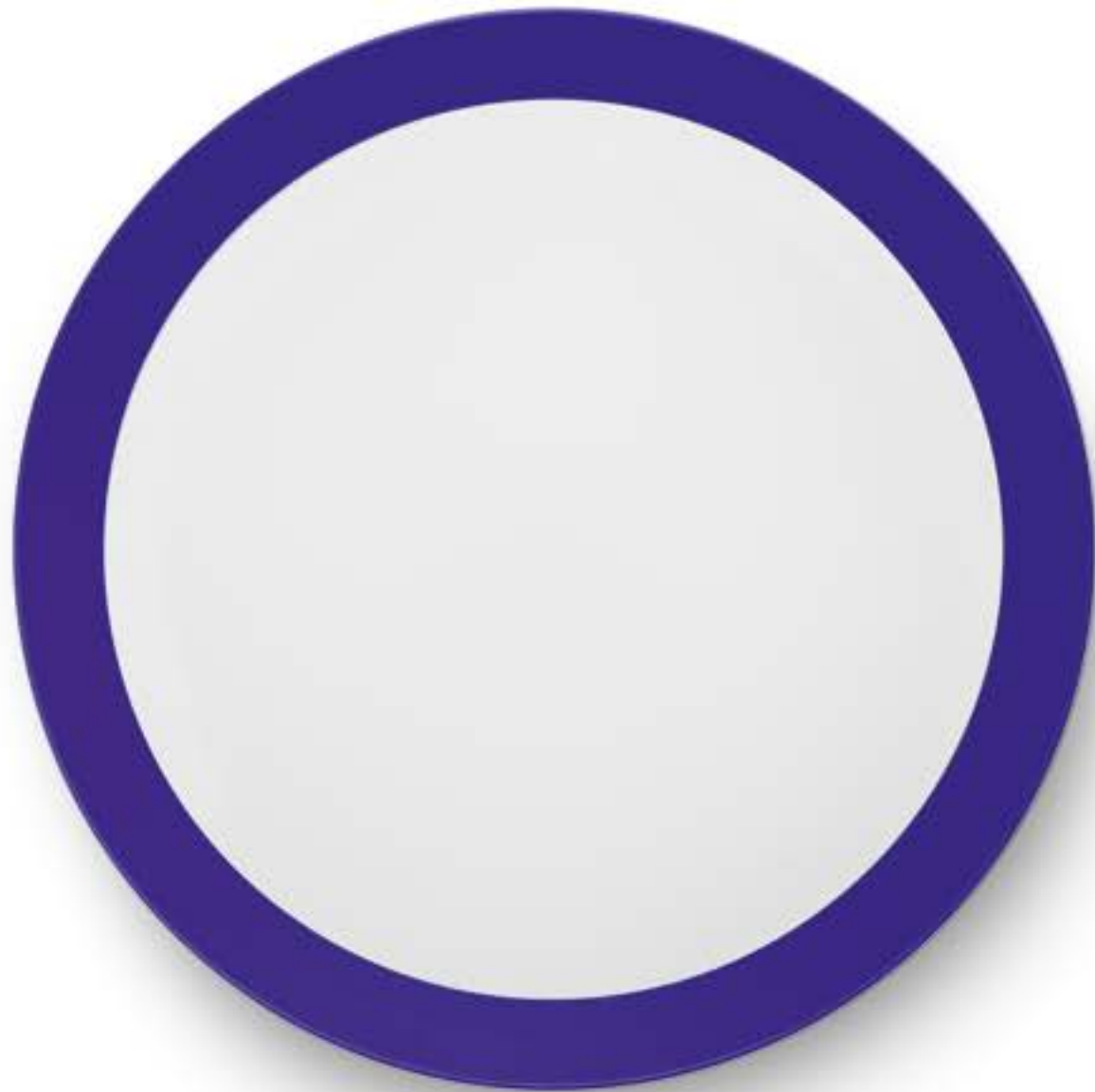

For further information on Tagora  
↪ visit [artemide.com](http://artemide.com)



**Artemide  
App**

↪ on request

Not for Tagora 80 ceiling version



# Tagora

## ↪ recessed



Series of ceiling mounted luminaires available in 4 diameters (80 mm, 270 mm, 570 mm, 970 mm), using high-output LEDs, Retrofit LEDs.

Consists of a trimless recessed frame fitted into the ceiling and an optical unit with an aluminium body painted in a range of colours.

Tagora 80 and 270 offer high-output spot light with aluminium optics.

Tagora 270 LED uses a proprietary system based on a hybrid combined lens and reflector optic. This system helps to create defined narrow beams using high-powered LED modules of large dimensions.

Tagora 570 and 970 cone with a PMMA diffuser, offering a comfortable diffused light, use high-output sources.

Integrated electronic power supply, dimmable or non-dimmable options, depending on the version.

Only ceiling recessed installation allowed.

Compliant with standard EN60598-1 and other specific standards.

## ↪ TAGORA RECESSED

Orange White Blue Green
F WF XF
IP20  
960°

**16**  
1.
  **01**  
2.
  **02**  
3.
  **09**  
4.

### TAGORA RECESSED 80

W	Weight	Beam	Flux	CCT	Code
14 W	0,35 kg	WF 36°	1027 lm	3000 K	<b>AB001.</b> 16/01/09/02
			1059 lm	4000 K	<b>AB004.</b> 16/01/09/02
		WF 44°	1110 lm	3000 K	<b>AB002.</b> 16/01/09/02
			1145 lm	4000 K	<b>AB005.</b> 16/01/09/02
		XF 52°	1015 lm	3000 K	<b>AB003.</b> 16/01/09/02
			1047 lm	4000 K	<b>AB006.</b> 16/01/09/02

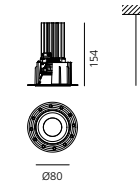

∅92

MacAdam 3SDCM  
Life L80 (9K) 50000h  
CRI=90

Electronic ballast 500mA Selv supplied separately.

Driver	Va	L <sub>mm</sub>	W <sub>mm</sub>	H <sub>mm</sub>	n°device	Code
cc 16W 500mA	220-240	156	52	26	1 max DALI dimmable	<b>M077401</b>

LED (GU10)	Weight	Code
220 V 240 V*	0,35 kg	<b>M0202.</b> 1/2/3/4 .0

\*Max 81mm (overall)

### TAGORA RECESSED 270

W	Weight	Beam	Flux	CCT	DALI Code
34 W	3,80 kg	F 16°	1804 lm	3000 K	<b>M2504.</b> 1/2/3/4 .1
			1926 lm	4000 K	<b>M2505.</b> 1/2/3/4 .1
		WF 32°	1636 lm	3000 K	<b>M2506.</b> 1/2/3/4 .1
			1744 lm	4000 K	<b>M2507.</b> 1/2/3/4 .1

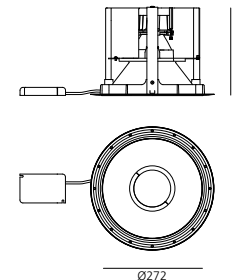

∅292

MacAdam 1SDCM  
Life L70 (6K) 50000h  
CRI=90

220/240Vac 50/60Hz electronic ballast included. Dimmable DALI-SwitchDim.  
Supply voltage 220-240V. Insulation class II. SELV. IP20.

## ↪ TAGORA RECESSED

Orange White Blue Green
F WF XF
MacAdam 3SDCM  
Life L70 (6K) 50000h  
CRI =80  
IP20  
960°

**16**  
1.
  **01**  
2.
  **02**  
3.
  **09**  
4.

### TAGORA RECESSED 570

W	Weight	Beam	Flux	CCT	DALI-SwitchDim Code
58 W	6,35 kg	XF	3593 lm	3000 K	<b>M2502.</b> 1/2/3/4 .1
			3820 lm	4000 K	<b>M2503.</b> 1/2/3/4 .1



∅606

220/240Vac 50/60Hz electronic ballast included. Dimmable DALI-SwitchDim.  
Supply voltage 220-240V. Insulation class II. SELV. IP20.

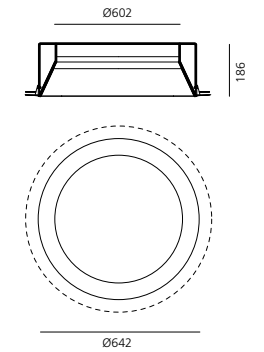

### TAGORA RECESSED 970

W	Weight	Beam	Flux	CCT	DALI-SwitchDim Code
84 W	21 kg	XF	6425 lm	3000 K	<b>M2500.</b> 1/2/3/4 .1
			6914 lm	4000 K	<b>M2501.</b> 1/2/3/4 .1



∅1002

220/240Vac 50/60Hz electronic ballast included. Dimmable DALI-SwitchDim.  
Supply voltage 220-240V. Insulation class II. SELV. IP20.

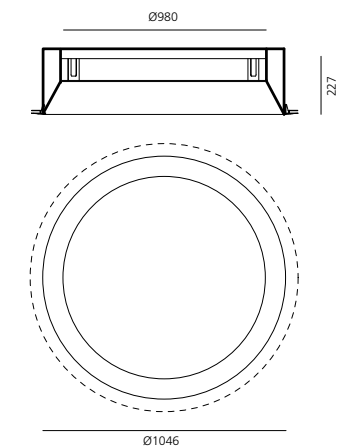



# Tagora ↪ ceiling



Series of ceiling mounted luminaires available in 4 diameters (80 mm, 270 mm, 570 mm, 970 mm), using high-output LEDs, Retrofit LEDs.

Aluminium body available in different two-coloured versions: beige/white, grey/white, black/orange, black/vert and black/blue.

Tagora 80 and 270 offer high-output spot light with aluminium optics.

Tagora 270 LED uses a proprietary system based on a hybrid combined lens and reflector optic. This system helps to create defined narrow beams using high-powered LED modules of large dimensions.

Tagora 570 and 970 come with a PMMA diffuser, offering a comfortable diffused light. LED versions use high-output sources.

Integrated electronic power supply, dimmable or non-dimmable options, depending on the version.

Only ceiling mounted installation allowed.

Compliant with standard EN60598-1 and other specific standards.

# ↳ TAGORA CEILING

Orange Black	Beige White	Blue Black	Green Black	Grey White	F	WF	XF	220/240Vac 50/60Hz electronic ballast included.	IP20/ IP40 ⊕ 960°
57	52	58	59	56					
1.	2.	3.	4.	6.					

## TAGORA CEILING 80

W	Weight	Beam	Flux	CCT
14 W	1,15 kg	WF 36°	1027 lm	3000 K
			1059 lm	4000 K
		WF 44°	1110 lm	3000 K
			1145 lm	4000 K
XF 52°	1015 lm	3000 K		
	1046 lm	4000 K		

Undimmable	DALI dimmable
Code	Code
AB061. 52/56/57/58/59	AB081. 52/56/57/58/59
AB064. 52/56/57/58/59	AB084. 52/56/57/58/59
AB062. 52/56/57/58/59	AB082. 52/56/57/58/59
AB065. 52/56/57/58/59	AB085. 52/56/57/58/59
AB063. 52/56/57/58/59	AB083. 52/56/57/58/59
AB066. 52/56/57/58/59	AB086. 52/56/57/58/59



MacAdam 3SDCM  
Life L80 (9K) 50000h  
CRI=90

LED (GU10)	Weight	Code
220 V	0,98 kg	M0189. 1/2/3/4/6 .0
240 V*		

\*Max 81mm (overall)

## TAGORA CEILING 270

W	Weight	Beam	Flux	CCT
34 W	3,74 kg	F 16°	1804 lm	3000 K
			1926 lm	4000 K
		WF 32°	1636 lm	3000 K
			1744 lm	4000 K

DALI dimmable
Code
M2484. 1/2/3/4/6 .1
M2485. 1/2/3/4/6 .1
M2486. 1/2/3/4/6 .1
M2487. 1/2/3/4/6 .1



MacAdam 1SDCM  
Life L70 (6K) 50000h  
CRI=90

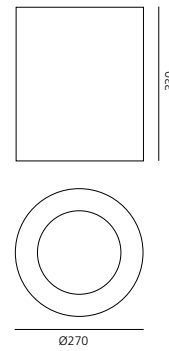

## TAGORA CEILING 570

W	Weight	Beam	Flux	CCT
58 W	4,90 kg	XF	3593 lm	3000 K
			3820 lm	4000 K

DALI dimmable
Code
M2482. 1/2/3/4/6 .1
M2483. 1/2/3/4/6 .1



IP40  
MacAdam 3SDCM  
Life L70 (6K) 50000h  
CRI=80

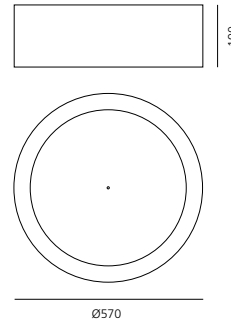

## TAGORA CEILING 970

W	Weight	Beam	Flux	CCT
84 W	16,24 kg	XF	6425 lm	3000 K
			6915 lm	4000 K

DALI dimmable
Code
M2480. 1/2/6 .1
3/4 .1
M2481. 1/2/6 .1
3/4 .1



IP40  
MacAdam 3SDCM  
Life L70 (6K) 50000h  
CRI=80

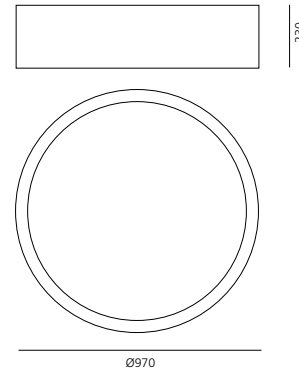

Vodafone Campus - Düsseldorf (Germany)  
Arch.: HPP Henrich-Peschding & Partner, Photo: Werner Hübner

# Tagora

## ↪ suspension



Series of suspended luminaires available in 4 diameters (80 mm, 270 mm, 570 mm, 970 mm), using high-output LEDs, Retrofit LEDs.

Aluminium body available in different two-coloured versions: beige/white, grey/white, black/orange, black/vert and black/blue.

Steel suspension cables allowing quick adjustment, 2 metre length.

Tagora 80 and 270 offer a high-output spot light with aluminium optics.

Tagora 270 uses a proprietary system based on a hybrid combined lens and reflector optic. This system helps to create defined narrow beams using high-powered LED modules of large dimensions.

Tagora 570 and 970 come with a PMMA diffuser, offering a comfortable diffused light. LED versions use high-output sources.

Integrated electronic power supply, dimmable or non-dimmable options, depending on the version.

Compliant with standard EN60598-1 and other specific standards.

## ↪ TAGORA SUSPENSION

Orange Black	Beige White	Blue Black	Green Black	Grey White	F	WF	XF	220/240Vac 50/60Hz electronic ballast included.	IP20 960°
1.	2.	3.	4.	5.					

### TAGORA SUSPENSION 80

W	Weight	Beam	Flux	CCT
14 W	1,15 kg	WF 36°	1027 lm	3000 K
			1059 lm	4000 K
		WF 44°	1111 lm	3000 K
			1145 lm	4000 K
		XF 52°	1015 lm	3000 K
			1047 lm	4000 K

Undimmable Code	DALI dimmable Code
<b>AB021.</b> 52/56/57/58/59	<b>AB041.</b> 52/56/57/58/59
<b>AB024.</b> 52/56/57/58/59	<b>AB044.</b> 52/56/57/58/59
<b>AB022.</b> 52/56/57/58/59	<b>AB042.</b> 52/56/57/58/59
<b>AB025.</b> 52/56/57/58/59	<b>AB045.</b> 52/56/57/58/59
<b>AB023.</b> 52/56/57/58/59	<b>AB043.</b> 52/56/57/58/59
<b>AB026.</b> 52/56/57/58/59	<b>AB046.</b> 52/56/57/58/59

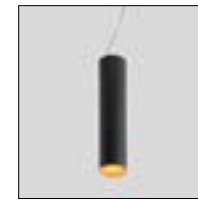

MacAdam 3SDCM  
Life L80 (9K) 50000h  
CRI=90

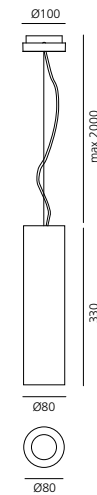

LED (GU10)	Weight	Code
220 V	1,03 kg	<b>M0191.</b> 1/2/3/4/6 .0
240 V*		

\*Max 81mm (overall)

### TAGORA SUSPENSION 270

W	Weight	Beam	Flux	CCT
34 W	4,65 kg	F 16°	1804 lm	3000 K
			1926 lm	4000 K
		WF 32°	1636 lm	3000 K
			1744 lm	4000 K

DALI dimmable Code
<b>M2496.</b> 1/2/3/4/6 .1
<b>M2497.</b> 1/2/3/4/6 .1
<b>M2498.</b> 1/2/3/4/6 .1
<b>M2499.</b> 1/2/3/4/6 .1



MacAdam 1SDCM  
Life L70 (6K) 50000h  
CRI=90

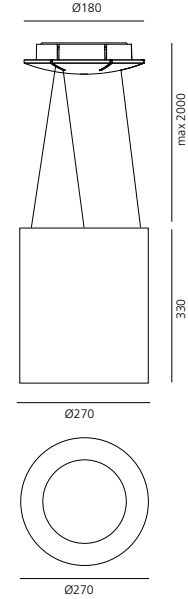

## ↪ TAGORA SUSPENSION

Orange Black	Beige White	Blue Black	Green Black	Grey White	XF	220/240Vac 50/60Hz electronic ballast included.	IP40 960°
1.	2.	3.	4.	5.			

### TAGORA SUSPENSION 570

Direct emission				
W	Weight	Beam	Flux	CCT
58 W	6,45 kg	XF	3593 lm	3000 K
			3820 lm	4000 K

DALI dimmable Code
<b>M2492.</b> 1/2/3/4/6 .1
<b>M2493.</b> 1/2/3/4/6 .1



MacAdam 3SDCM  
Life L70 (6K) 50000h  
CRI=80

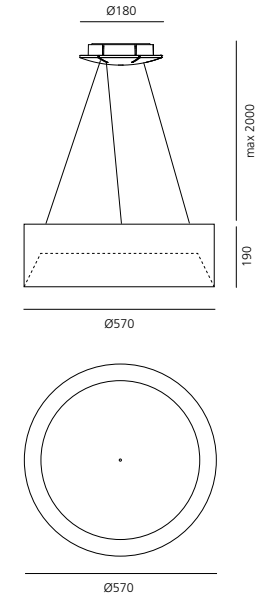

Direct + indirect emission				
W	Weight	Beam	Flux	CCT
72 W	6,62 kg	XF	4675 lm	3000 K
			4944 m	4000 K

DALI dimmable Code
<b>M2402.</b> 1/2/3/4/6 .1
<b>M2403.</b> 1/2/3/4/6 .1

### TAGORA SUSPENSION 970

Direct emission				
W	Weight	Beam	Flux	CCT
84 W	21 kg	XF	6425 lm	3000 K
			6915 lm	4000 K

DALI dimmable Code
<b>M2488.</b> 1/2/3/4/6 .1
<b>M2489.</b> 1/2/3/4/6 .1



MacAdam 3SDCM  
Life L70 (6K) 50000h  
CRI=80

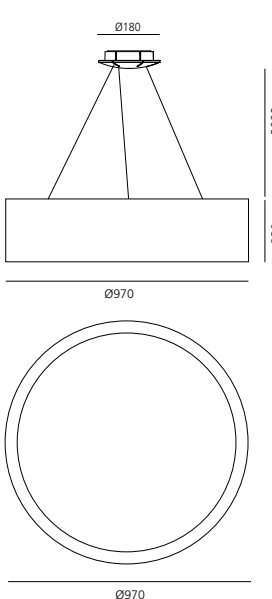







# Mouette

Wilmotte & Industries

↪ 2004

Suspension light fitting with diffused emission.

Versions: Mouette symmetric, Mouette asymmetric.

Solid opal diffuser in moulded polypropylene.

Luminous flux distribution:

74% in direct emission,

26% in indirect emission.

DALI dimmable.

The light fitting is equipped with quick-adjustment steel suspension cables, ceiling plate and power cable.

Cable length: Mouette: 2m or 6m,

Mouette mini: 2m.

Complies with standard EN60598-1 and other specific standards.



For further information on Mouette  
↪ visit [artemide.com](http://artemide.com)



Artemide  
App

↪ on request

## MOUETTE

Opal white  
20

XF

MacAdam 2SDCM  
Life L70 (6K) 50000h  
CRI = 80

IP20 / IP40  
750°

### MOUETTE SYMMETRIC

W	Flux	CCT	Weight	Cable length	Undimmable Code	DALI dimmable Code
105 W	13824lm	3000 K	8,50 kg	1900mm	<b>AK00400</b>	<b>AK00300</b>
			8,60 kg	5900mm	<b>AK10400</b>	<b>AK10300</b>

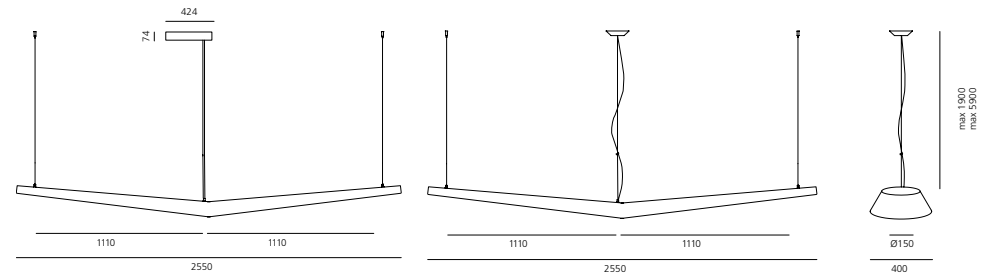

### MOUETTE SYMMETRIC

W	Flux	CCT	Weight	Cable length	Undimmable Code	DALI dimmable Code
55 W	6221lm	3000 K	5,40 kg	1900mm	<b>AK00200</b>	<b>AK00100</b>
			5,50 kg	5900mm	<b>AK10200</b>	<b>AK10100</b>

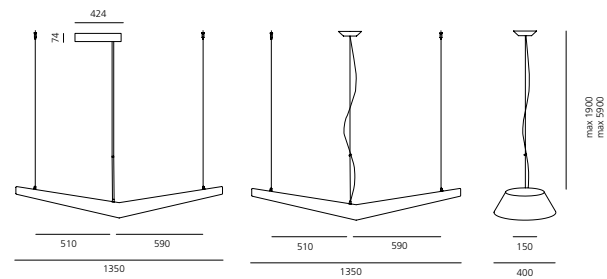

### MOUETTE ASYMMETRIC

W	Flux	CCT	Weight	Cable length	Undimmable Code	DALI dimmable Code
80 W	10368lm	3000 K	6,80 kg	1900mm	<b>AK00600</b>	<b>AK00500</b>
			6,90 kg	5900mm	<b>AK10600</b>	<b>AK10500</b>

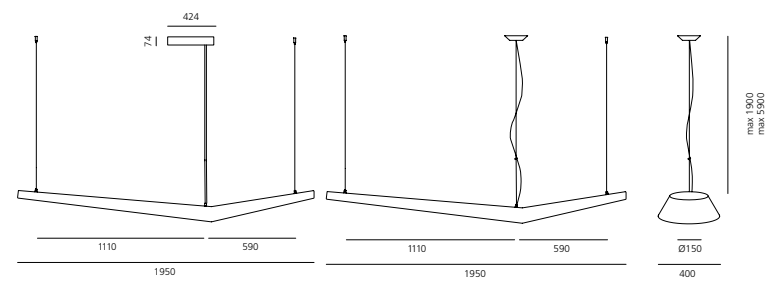





↪ Outdoor

# General Lighting Path Lighting



"O" _____	678	
Walking _____	690	
Antarktikós _____		708
Reeds _____	712	
Tetragono _____		720
Ippolito _____	724	
Piroscafo _____		726
Oblique _____	730	
Basolo _____	734	
Cuneo _____	736	
Niki _____	740	
Dioscuri _____		744
Nuda _____	746	
Ciclope _____		754
Chilone _____		760
Granito _____		768
Effetto _____		778
Calumet _____		772
Molla _____	776	
Tolomeo Outdoor _____		788
Tolomeo XXL _____		784



“O”

Elemental  
↪ 2018

O  
Light without a lamp for public space

The more the planet becomes urban, the more we appreciate the value of natural spaces. The cities with the highest quality of life are those that were visionary enough to keep portions of untouched nature within their footprint and transform them into public spaces. Forest that can become parks, rivers that can become pools, hills that can become viewpoints or beaches that can become promenades measure the capacity of a city to provide the right environment for their citizens.

The problem is that the forces that govern nature and modern urban life, even if guided by good will, tend to pull in opposite directions. If we want to access a hill, we erode its slopes with roads. If we want to prevent a river's flooding, we alter its basin's permeability. If we want to keep a park clean, we invade it with garbage cans. If we want to illuminate it to make it safe, we invade it with posts and cables.

One of the strongest intrusions in the natural order (and yet one of that remains almost unnoticed) is the disappearance of darkness in our cities. In the attempt to make parks safe, we not only invade them with posts and cables, but we alter forever the circadian rhythm that is crucial for the existence of species, both animal and vegetal.

Our project for Artemide is an attempt to reconcile the needs of the natural and the urban environment. Our strategy is twofold: on the one hand is to design a light for the public space that when not in use can be as imperceptible as possible; light without a lamp. On the other hand is to take advantage of different types of sensors so that light appears just when needed; light only on demand.

For such aims we started from the Discovery lamp developed by Artemide: a disc of Polymethyl methacrylate (PMMA), transparent when not in use, but "carved" with some invisible laser insertions in its mass, so that when the LED in the peripheral ring is turned on, the whole mass becomes the light source.

For O we envision a series of discs that interfere as little as possible an existing landscape, but that when activated by people's motion, they illuminate the adjacent space for only a limited amount of time. Darkness and Disappearance will be the contribution of O to nature and public space.

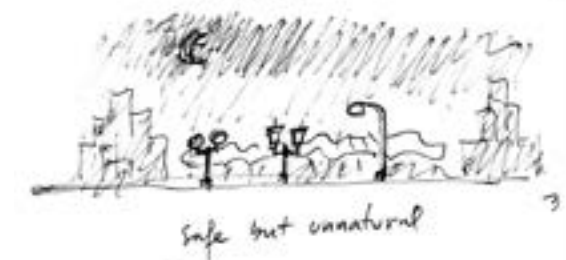
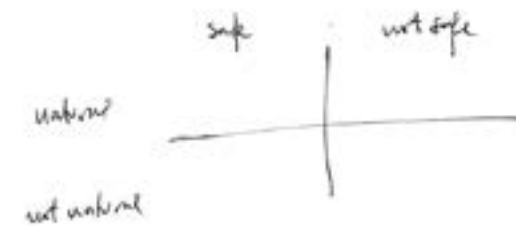







# “O” typologies

## SUSPENSION



“O” Ø 900



XF  
42 W  
1595 lm

“O” Ø 450



XF  
22 W  
859 lm

Extruded and calendered  
aluminium ring, silicone diffuser,  
die-cast aluminium base



Artemide  
App

## FLOOR



“O” Ø 900



XF  
42 W  
1595 lm

“O” Ø 900 INDOOR



XF  
42 W  
1595 lm

“O” Ø 450



XF  
22 W  
859 lm

## WALL/CEILING



“O” Ø 450





XF  
22 W  
859 lm

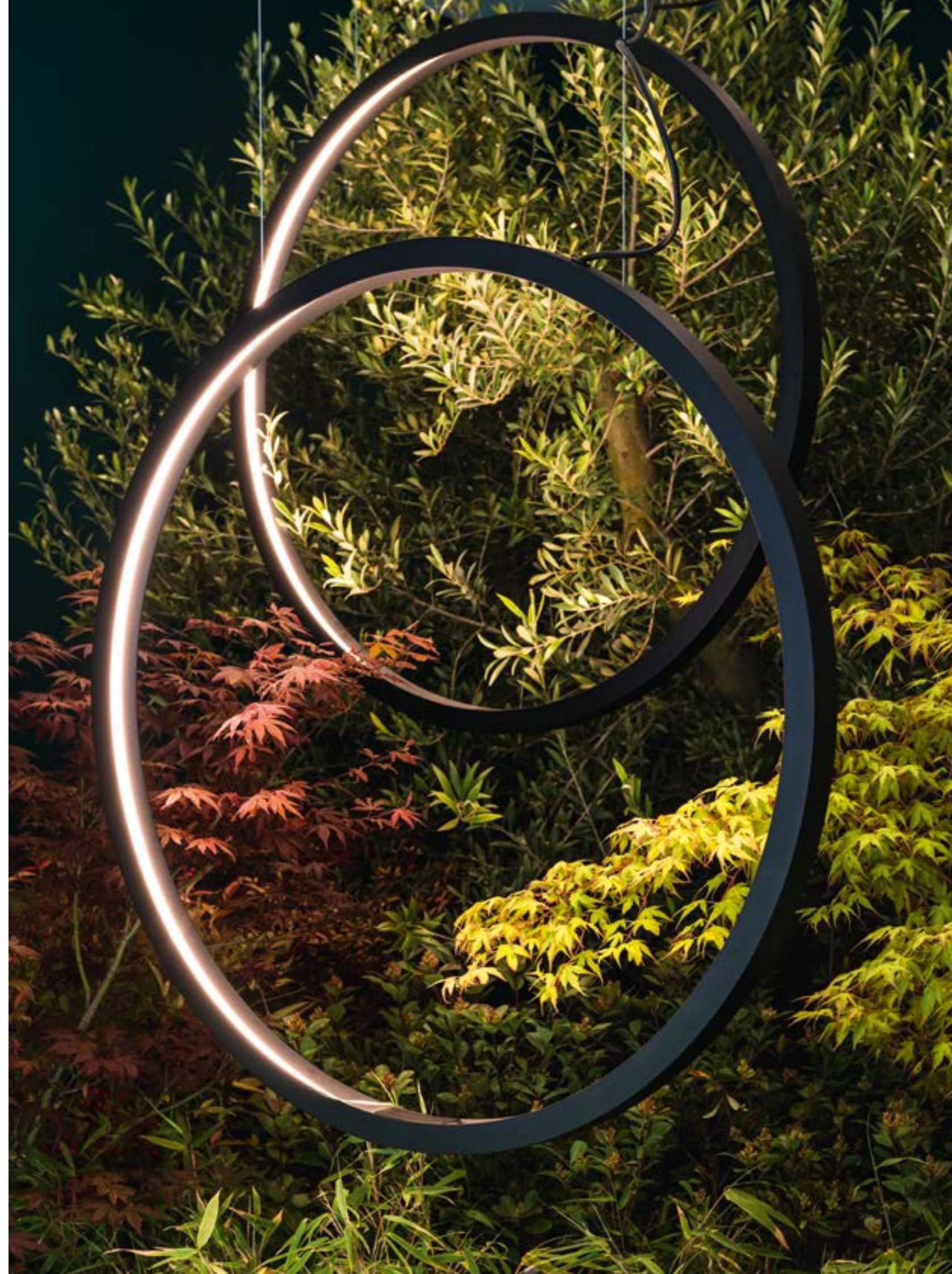

For further information on “O”  
↪ visit [artemide.com](http://artemide.com)



Black	XF	MacAdam 3SDCM	IP67
		Life L70 (6K)>40000h	
		CRI =90	

“O” SUSPENSION

IP67					IP67
Ø	W	Beam	Flux	CCT	Code
900 mm	42 W	XF	1595 lm	3000K	T072030

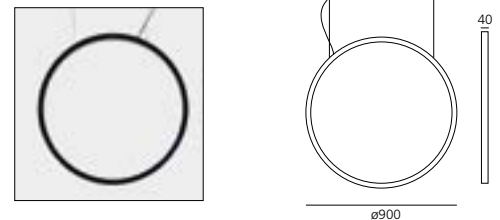

“O” FLOOR

IP67					IP67
Ø	W	Beam	Flux	CCT	Code
900 mm	42 W	XF	1595 lm	3000K	T071030

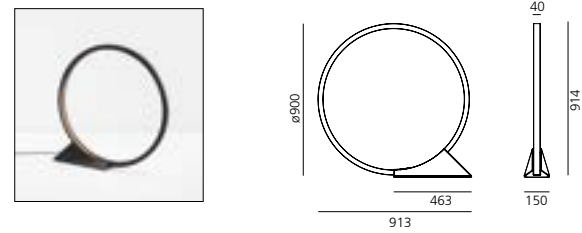

“O” FLOOR INDOOR

IP20					IP20
Ø	W	Beam	Flux	CCT	Code
900 mm	42 W	XF	1595 lm	3000K	T073030
				APP	T073030APP



“O” 45 SUSPENSION

IP67					IP67
Ø	W	Beam	Flux	CCT	Code
450 mm	22 W	XF	859 lm	3000K	T072130

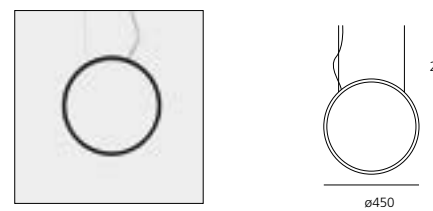

“O” 45 FLOOR / WALL / CEILING

IP67					IP67
Ø	W	Beam	Flux	CCT	Code
450 mm	22 W	XF	859 lm	3000K	T071130

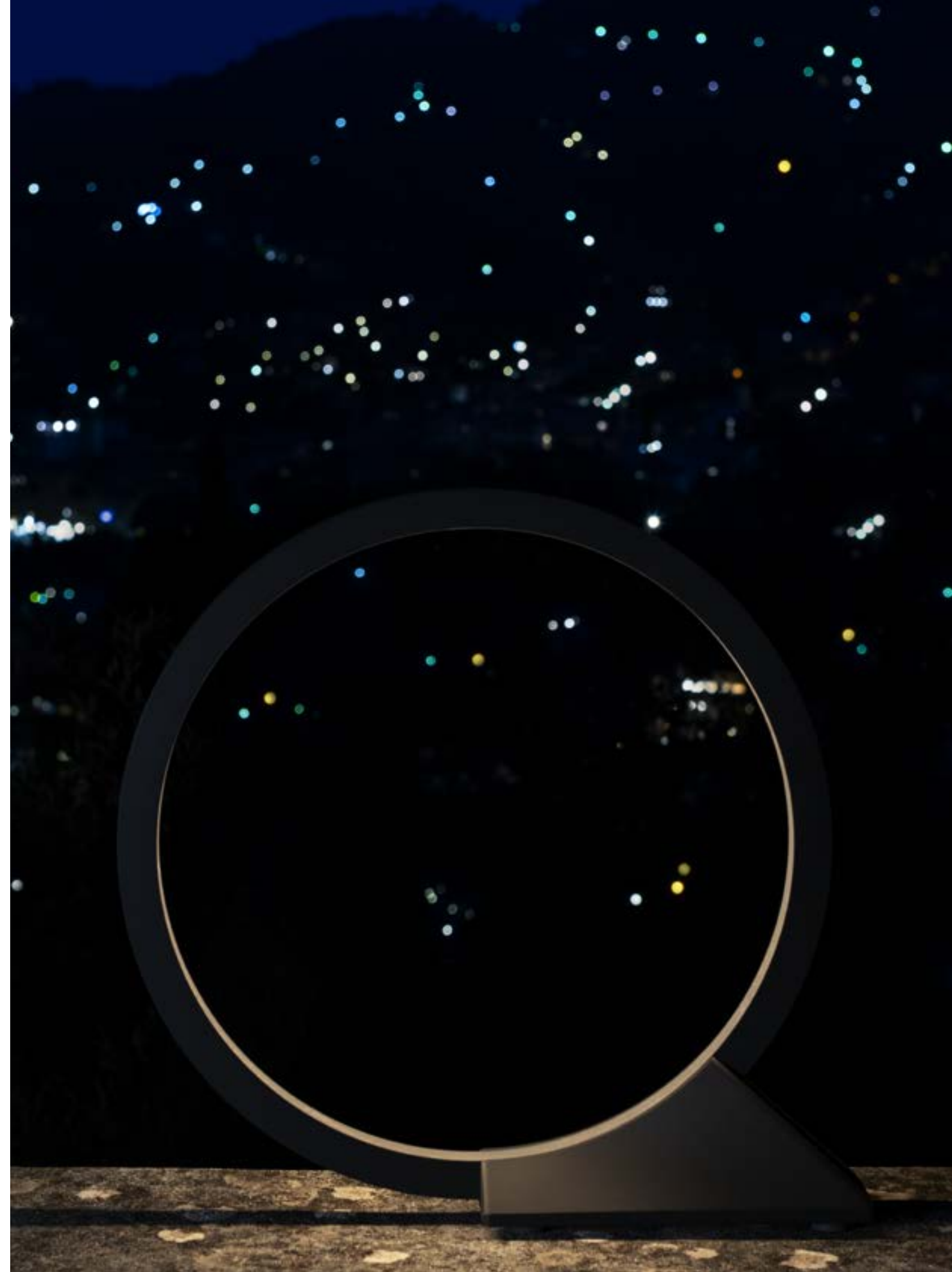
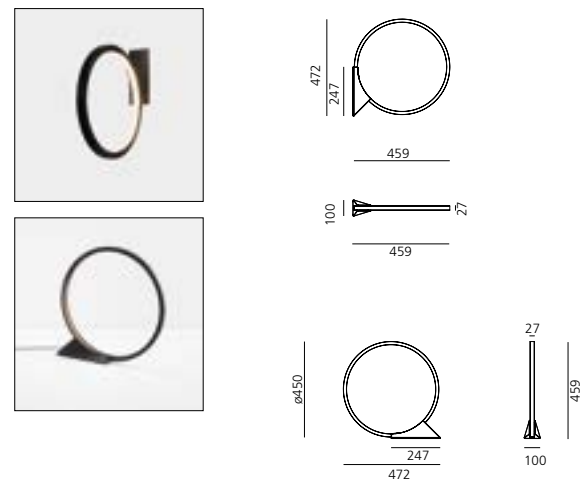

# Walking

Carlotta de Bevilacqua

↪ 2017



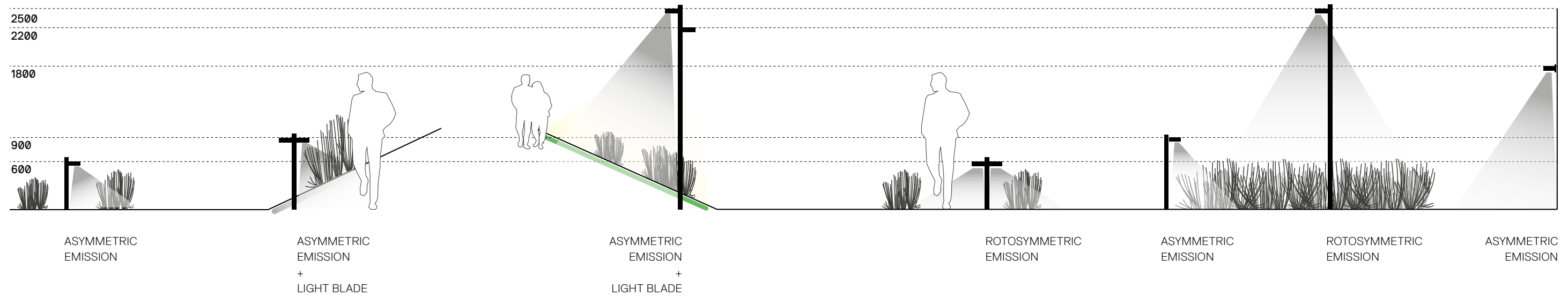

# Walking optical system

It can create different luminous landscapes starting from three white or coloured lighting performances, either single or combined within the same element according to a space gradient of structures of different heights.

It defines a new, exciting lighting language, respectful of the surrounding space, which it approaches with deeds that promote its perception and a man-sized experience. A dynamic discovery of space that is allowed, among other things, by the possible interaction with sensors, the Artemide App and advanced intelligences.

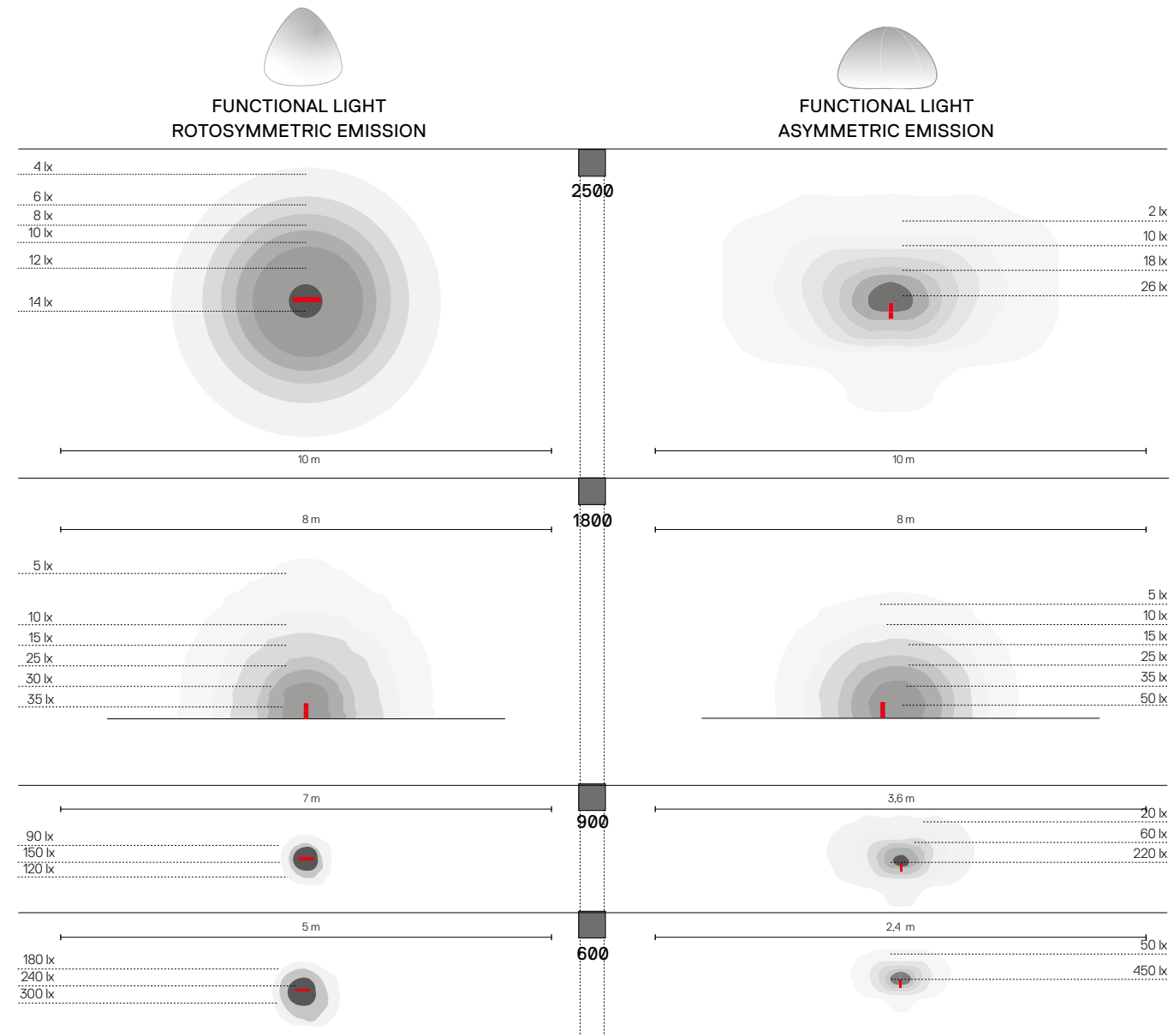
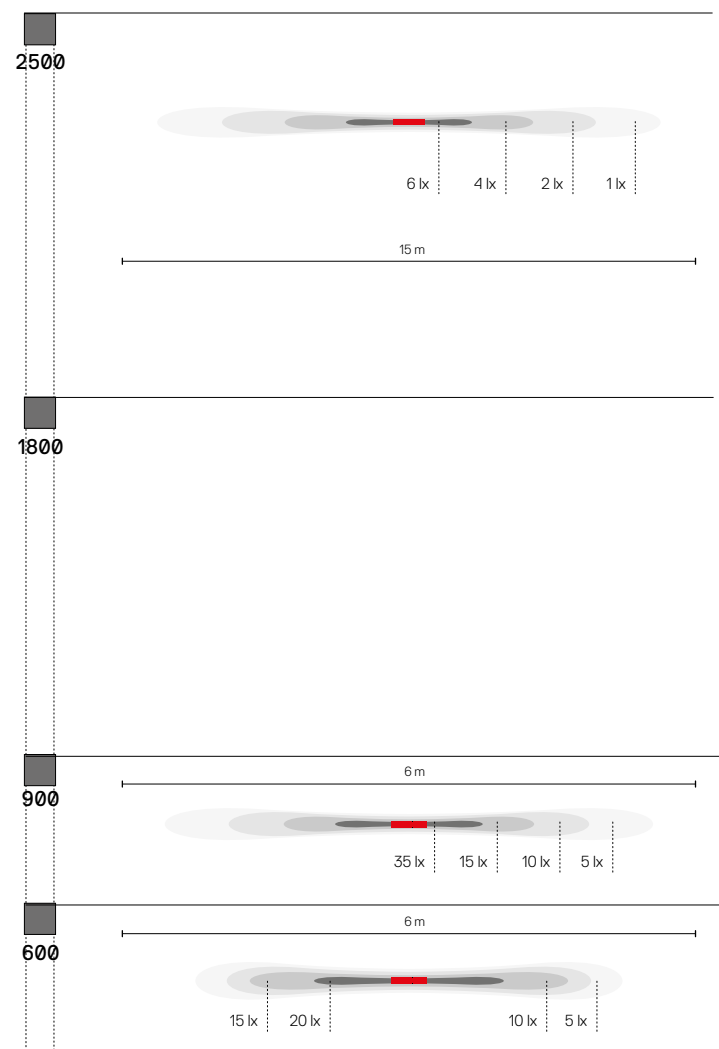

# Walking head pole typologies

# Walking wall typologies

## FUNCTIONAL LIGHT



ROTSYMMETRIC EMISSION



5 2x63°  
10,3W  
334 lm



ASYMMETRIC EMISSION



5 2x60° / 16°+54°  
10,3W  
455 lm

## LIGHT BLADE



RED EMISSION



GREEN EMISSION



BLUE EMISSION



WHITE EMISSION

## FUNCTIONAL LIGHT



ROTSYMMETRIC EMISSION



5 2x63°  
10,3W  
334 lm



ASYMMETRIC EMISSION



5 2x60° / 16°+54°  
10,3W  
455 lm

## LIGHT BLADE



RED EMISSION



GREEN EMISSION

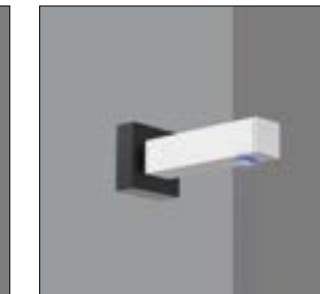

BLUE EMISSION



WHITE EMISSION



Artemide  
App  
↪ on request



For further information on Walking  
↪ visit [artemide.com](http://artemide.com)

# Walking pole configuration typologies

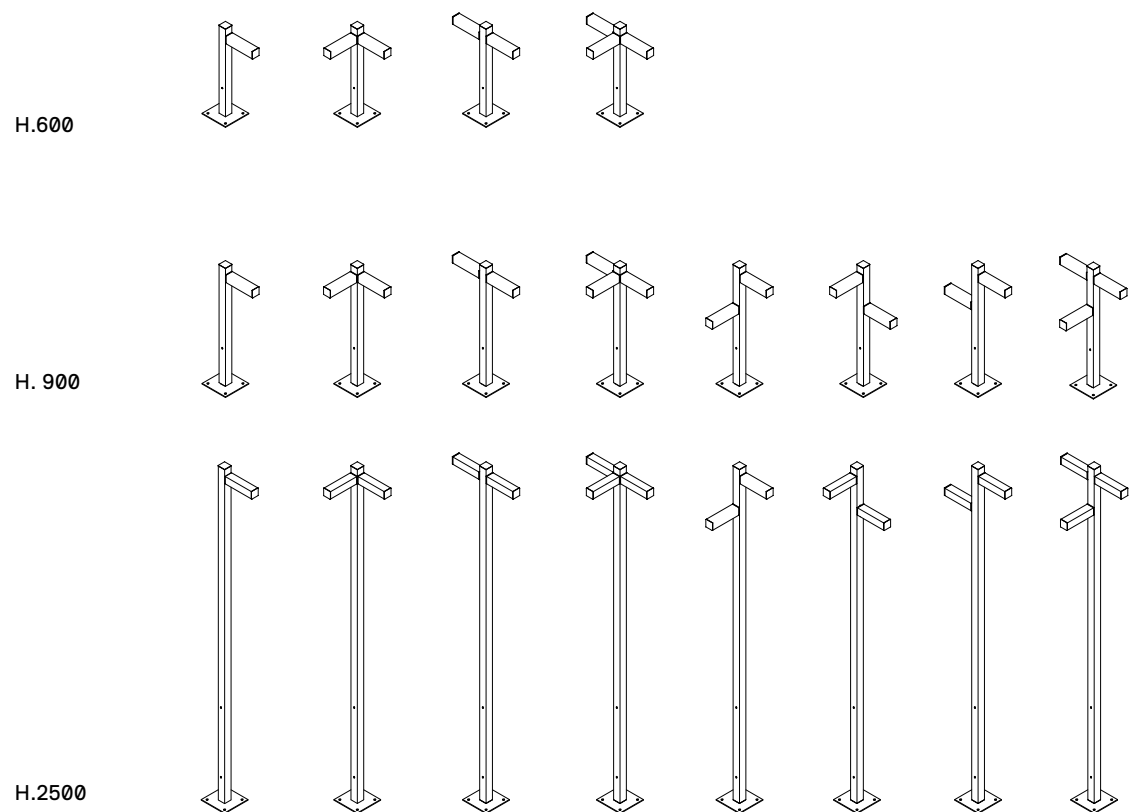
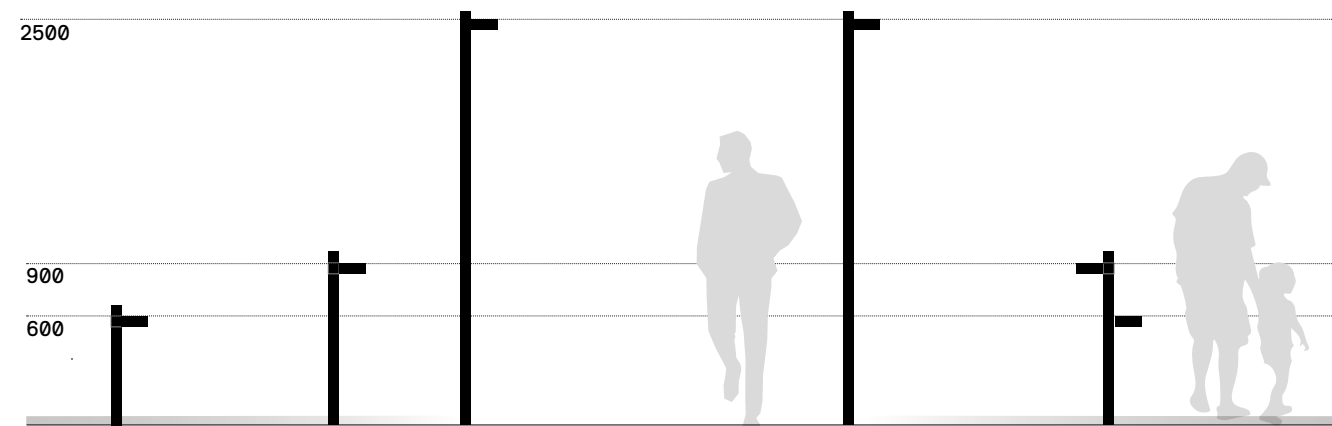





# Walking head colors

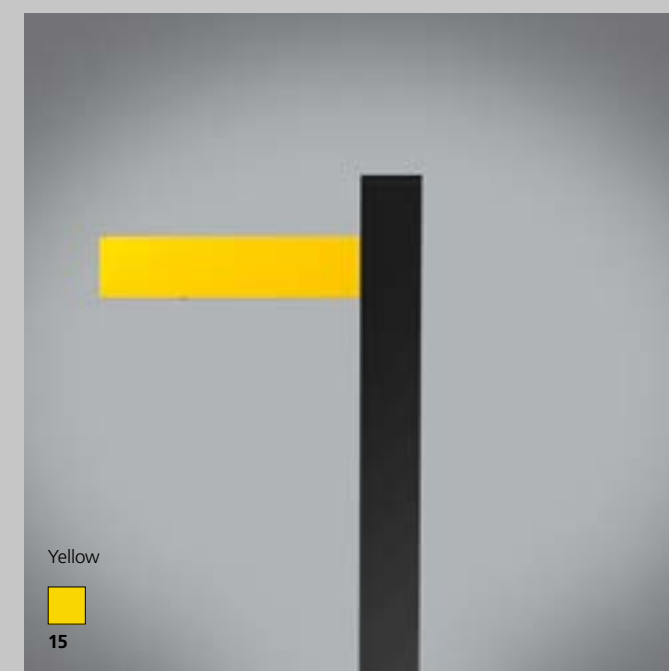
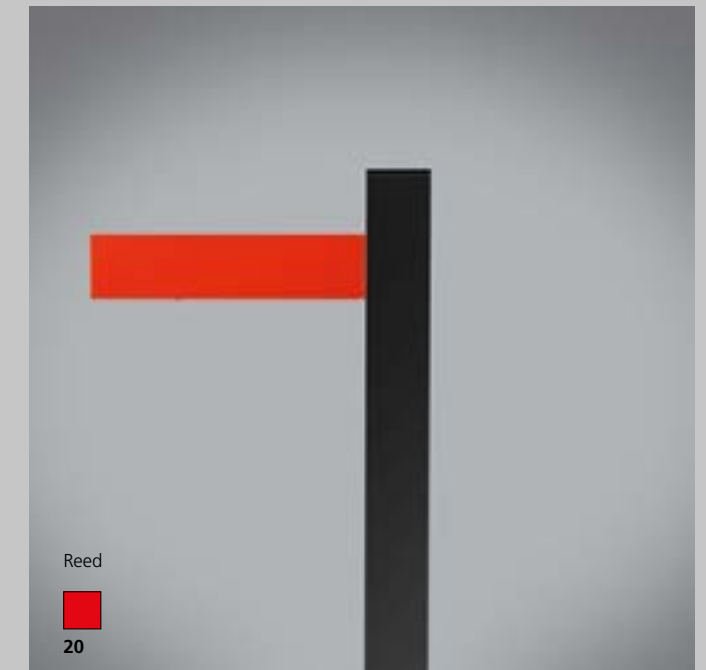
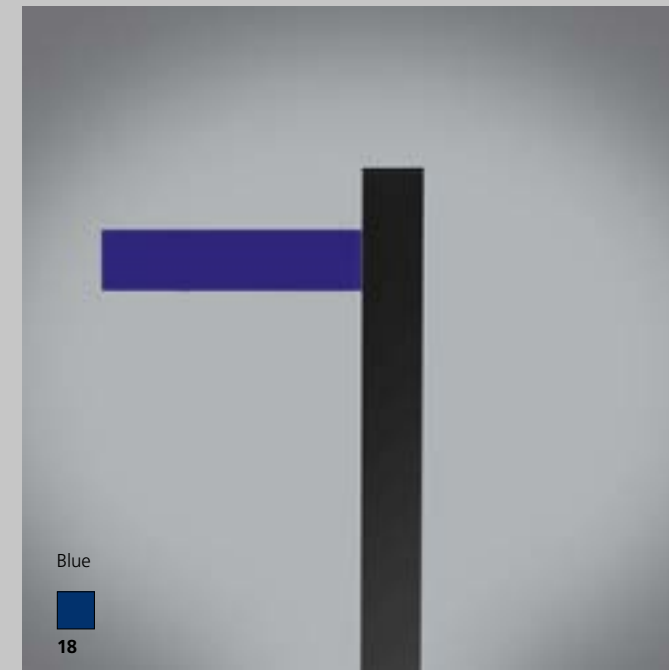
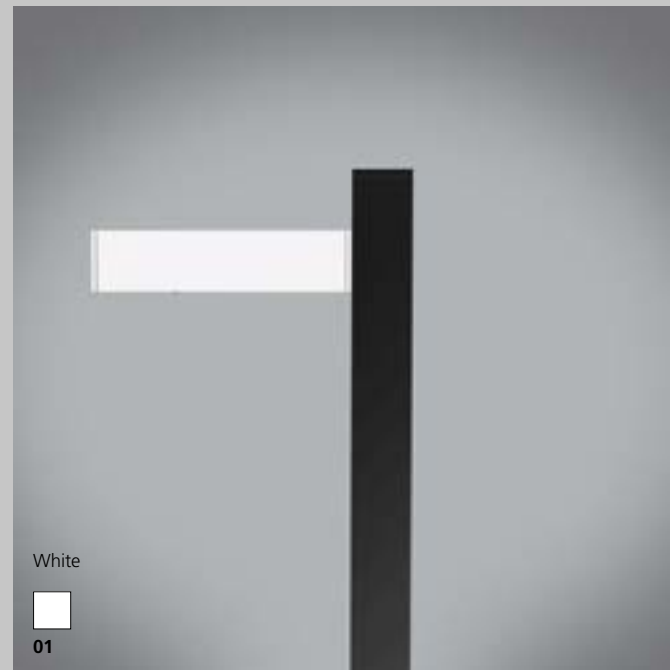

## ↪ WALKING - POLE

Black



### POLE 600

#### Pole configuration

	Head	A Head	Code
	1x	60 h.	<b>T4505A30</b>
	2x90°	60 h.	<b>T4505B30</b>
	2x180°	60 h.	<b>T4505C30</b>
	3x270°	60 h.	<b>T4505D30</b>

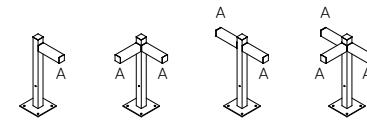

### POLE 900

#### Pole configuration

	Head	A Head up	B Head down	Code
	1x	90 h.		<b>T4506A30</b>
	2x90°	90 h.		<b>T4506B30</b>
	2x180°	90 h.		<b>T4506C30</b>
	3x180°	90 h.		<b>T4506D30</b>
	2x90°	90 h.	60 h.	<b>T4506E30</b>
	2x90°	90 h.	60 h.	<b>T4506F30</b>
	2x180°	90 h.	60 h.	<b>T4506G30</b>
	3x180°	90 h.	60 h.	<b>T4506H30</b>

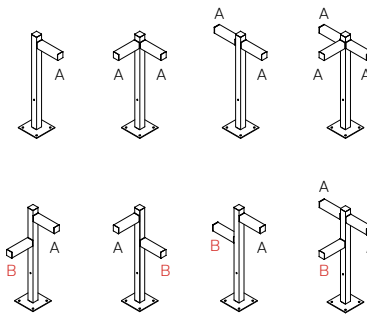

### POLE 2500

#### Pole configuration

	Head	A Head up	B Head down	Code
	1x	250 h.		<b>T4507A30</b>
	2x90°	250 h.		<b>T4507B30</b>
	2x180°	250 h.		<b>T4507C30</b>
	3x180°	250 h.		<b>T4507D30</b>
	2x90°	250 h.	210 h.	<b>T4507E30</b>
	2x90°	250 h.	210 h.	<b>T4507F30</b>
	2x180°	250 h.	210 h.	<b>T4507G30</b>
	3x180°	250 h.	210 h.	<b>T4507H30</b>

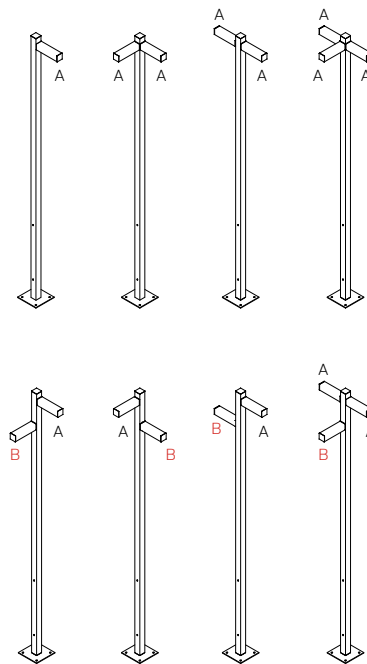

## ↪ WALKING - HEAD POLE

Grey-white Ral 9002	Blue	Black	Red	Yellow
20	50	30	40	60

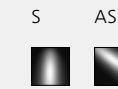

MacAdam 7SDCM  
Life L90 (10K)>60500h  
CRI =80

IP65

### FUNCTIONAL LIGHT

W	L. Cable	Beam	Flux	CCT	Code
10,3 W	270	S	334 lm	3000K	<b>T4501SM0.</b> 20/30/40/50/60
		AS	455 lm	3000K	<b>T4501AS0.</b> 20/30/40/50/60

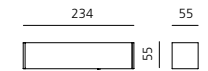
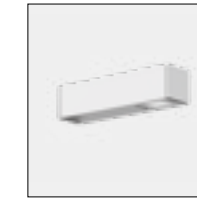

### LIGHT BLADE

W	L. Cable	Light color	Code
10,3 W	270	Red	<b>T4501LR0.</b> 20/30/40/50/60
		Green	<b>T4501LG0.</b> 20/30/40/50/60
		Blue	<b>T4501LB0.</b> 20/30/40/50/60
		White	<b>T4501LW0.</b> 20/30/40/50/60

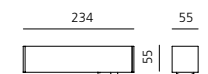
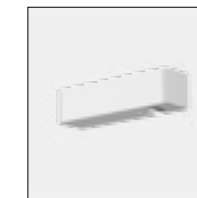



↪ WALKING - WALL

Grey-white Ral 9002	Blue	Black	Red	Yellow	S	AS	MacAdam 7SDCM	IP65
							Life L90 (10K)>60500h	
20	50	30	40	60			CRI = 80	

FUNCTIONAL LIGHT

W	L. Cable	Beam	Flux	CCT	Code
10,3 W	270	S	334 lm	3000K	<b>T4503SM0.</b> 20/30/40/50/60
		AS	455 lm	3000K	<b>T4503AS0.</b> 20/30/40/50/60

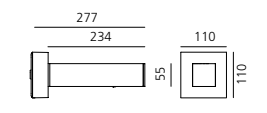

LIGHT SIGNS

W	L. Cable	Light color	Code
10,3 W	270	Red	<b>T4503LR0.</b> 20/30/40/50/60
		Green	<b>T4503LG0.</b> 20/30/40/50/60
		Blue	<b>T4503LB0.</b> 20/30/40/50/60
		White	<b>T4503LW0.</b> 20/30/40/50/60

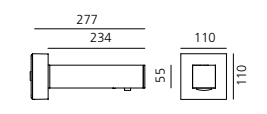

# Antarktíkós

Carlotta de Bevilacqua

↔ 2017

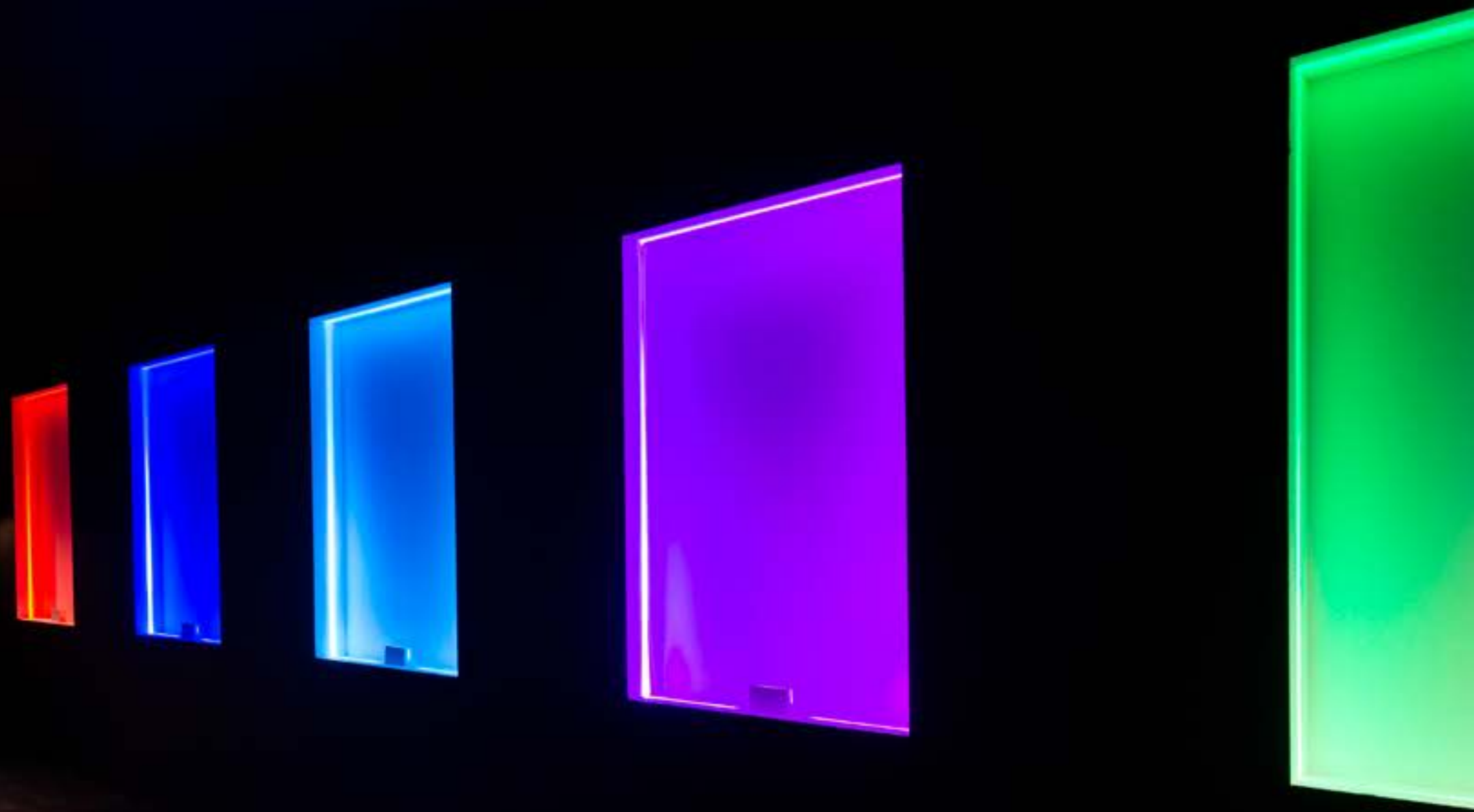

# Antarktíkós optic system

An innovative patented optic realizes a light blade that, from a single LED source, draws a 360° light profile. A perfect tool for architectural lighting that emphasizes with high efficiency the different opening profiles.

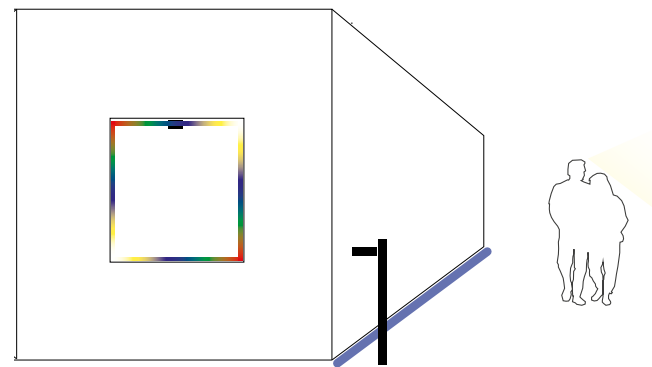

For further information on Antarktíkós  
visit [artemide.com](http://artemide.com)

## LIGHT TEMPERATURES AND COLORS

3000 K

RGB

## ↪ ANTARKTIKÓS

Grey-white  
Ral 9002



AS



Driver 500/700mA  
supplied separately.

MacAdam 7SDCM  
Life L70 (10K)>35500h  
CRI =80

IP65  
IK06

### ANTARKTIKÓS WHITE

W	Flux	CCT	Code
3 W	31 lm	3000K	<b>T4520030</b>

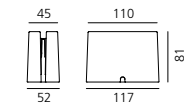

Driver	Vac	L <sub>mm</sub>	W <sub>mm</sub>	H <sub>mm</sub>	IP	n°device in series	Code		
cc 10W	700mA	220-240	75	38	25	20	1-4max	Undimmable	<b>NL19035</b>
cc 14W	700mA	220-240	79	38	25	67	1-5max	Undimmable	<b>DV3003</b>
cc 25W	900mA	220-240	164	38	25	20	1-9max	DALI/PUSH dimmable	<b>DV1003</b>
cc 38W	900mA	220-240	185	35	33	67	1-12max	DALI/PUSH dimmable	<b>DV1042</b>

### ANTARKTIKÓS RGB

W	Flux	Code
3 W	31 lm	<b>T4521030</b>

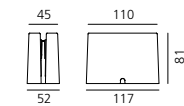

Driver	Vin	Vac	L <sub>mm</sub>	W <sub>mm</sub>	H <sub>mm</sub>	IP	n°device in series	Code
25 W	100-277 Vac	12Vdc	148	40	32	67	max 5	<b>DV1055</b>
40 W	100-277 Vac	12Vdc	163	43	32	67	max 8	<b>DV1056</b>
96 W	100-277 Vac	12Vdc	140	63	32	67	max 20	<b>DV1057</b>
150 W	100-277 Vac	12Vdc	228	68	39	67	max 30	<b>DV1043</b>
DIMMER DMX	12-24 Vdc	12-24 pwm	88	54	25	20	max 1	<b>DV1059</b>
DIMMER DALI	12-24 Vdc	12-24 pwm	88	54	25	20	max 1	<b>DV1052</b>

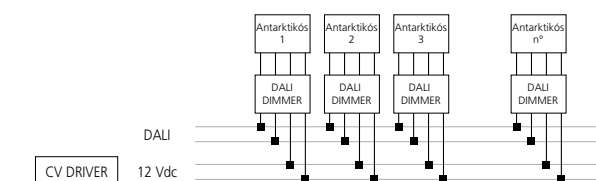
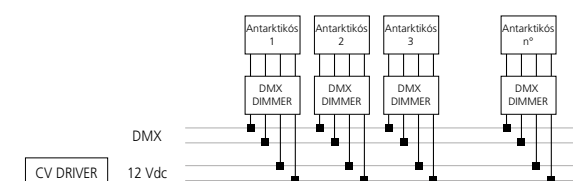

# Reeds

Klaus Begasse

↪ 2013

Floor light fixture with diffuse emission, with monochromatic LED light sources. Available with IP20 protection rating for indoors, IP67 and IP68 for outdoors. IP67 and IP68 versions are available in Single or Triple shape.

Light is diffused through 7 PMMA rods with different heights to give the impression of a reed bed and which can be screwed to the base by means of AISI 316 stainless steel bushes. Part of the light is also diffused on the floor around the base.

The base has an irregular shape, which has been designed to allow a «mosaic» connection with other light fixtures so as to create an elaborate composition as needed.

Technical features in compliance with EN60598-1 (IP20, IP67) and section 2-18 (IP68).

## Reeds IP20

Consists of a base made up of a transparent polycarbonate casing. Installed between 2 aluminium plates and anti-scratch support feet.

Technopolymer aesthetic cover.

Complete with integrated ballast and plug with transparent cable. Switching on and off are performed by means of the pedal push button located on the cable.

## Reeds IP67

Consists of a base made up of a transparent polycarbonate casing installed between 2 AISI316 stainless steel plates fixed by means of AISI316 stainless steel screws. Water sealing is assured by a silicone gasket. The light fixture can be fastened to the floor by means of the holes in the lower plate. Technopolymer aesthetic cover.

Complete with integrated ballast and supplied with a 1.5 m-long H05RN-F 2x1 cable provided with IP67 connector for the electrical connection to the mains suitable for 5-13.5mm diameter cables.

## Reeds IP68

Consists of a base made up of a transparent polycarbonate casing installed between 2 AISI316 stainless steel plates fixed by means of AISI316 stainless steel screws. Water sealing is assured by a silicone gasket. The light fixture can be fastened to the floor by means of the holes in the lower plate. Technopolymer aesthetic cover.

The light fixture is supplied with 24V DC power and is provided with a 5 m-long H05RN-F 2x1 cable with IP68 connector for the electrical connection to the mains suitable for 5-13.5mm diameter cables.



For further information on Reeds  
↪ visit [artemide.com](http://artemide.com)







↪ REEDS

Anthracite Grey 20	AS	220/240Vac 50/60Hz electronic ballast included	MacAdam 4SDCM Life L70 (6K)>35600h CRI =80	IP20/IP67/IP68 IK10
-----------------------	----	--	--	------------------------

IP20

W	Weight	Beam	Flux	CCT	Code
9,5 W	1,73 kg	AS	79 lm	3000K	<b>T087300</b>

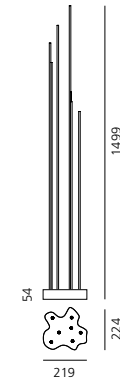
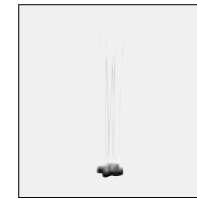

IP67

W	Weight	Beam	Flux	CCT	Code
9,5 W	2,53 kg	AS	79 lm	3000K	<b>T087400</b>

Electronic ballast included.

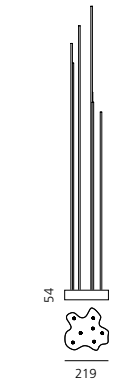
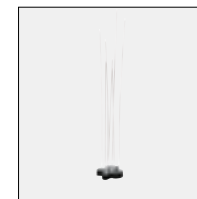

IP68

W	Weight	Beam	Flux	CCT	Code
9,5 W	2,53 kg	AS	79 lm	3000K	<b>T087500</b>

Electronic ballast 24Vdc supplied separately.  
Please see page 945 for drivers installation details.

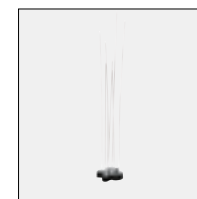

Driver	VaC in	VaC out	Lmm	Wmm	Hmm	IP	Code
25 W 24Vdc	110-277	24	150	40	32	67	<b>T409996</b>
60 W 24Vdc	110-277	24	165	43	32	67	<b>T409998</b>
90 W 24Vdc	110-277	24	165	61	36	67	<b>T409999</b>

↪ REEDS TRIPLE

Anthracite Grey 20	AS	220/240Vac 50/60Hz electronic ballast included	MacAdam 4SDCM Life L70 (6K)>35600h CRI =80	IP20/IP67/IP68 IK10
-----------------------	----	--	--	------------------------

IP67

W	Weight	Beam	Flux	CCT	Code
28 W	7,38 kg	AS	237 lm	3000K	<b>T087700</b>

Electronic ballast included.

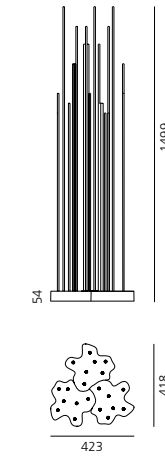

IP68

W	Weight	Beam	Flux	CCT	Code
28 W	7,38 kg	AS	237 lm	3000K	<b>T087800</b>

Electronic ballast 24Vdc supplied separately.  
Please see page 945 for drivers installation details.

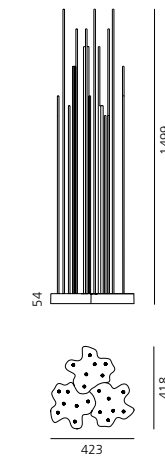

Driver	VaC in	VaC out	Lmm	Wmm	Hmm	IP	Code
60 W 24Vdc	110-277	24	165	43	32	67	<b>T409998</b>
90 W 24Vdc	110-277	24	165	61	36	67	<b>T409999</b>



# Tetragono

Ernesto Gismondi

↪ 2013



For further information on Tetragono  
↪ visit [artemide.com](http://artemide.com)

Lighting fixtures with direct asymmetrical light (floor version) and radial emission (wall version), with monochromatic LED light sources.

Floor or wall installation.

Finishing: anthracite grey painted.

Technical features of light fixtures in compliance with EN60598-1.

ENEC approved.

Tetragono floor: consists of lamp and supporting pole in extruded EN-AW-6060 aluminium, subjected to chromate treatment and painted, height 450 and 900mm, with painted steel base flange, with holes for floor installation by means of log bolts or dowels.

Tetragono wall: light fixture with radial light emission, consists of body and wall fixing plate; Lamp support in extruded EN-AW-6060 aluminium, subjected to chromate treatment and painted, with painted steel base flange, with holes for wall installation.

Lighting unit in die-cast EN-AB 47100 aluminium painted with 3-stage outdoor treatment: nanotechnologies, anti-oxidising primer, polyester paint.

Provided with metalised polycarbonate reflectors.

UV resistant diffuser in shock resistant polycarbonate with bright finish.

AISI 316 fixing screws and silicone gaskets.

Provided with cable and IP68 connector for the connection to the mains suitable for 5-13.5mm diameter cables (floor version) or for max 3,5mm diameter cables (wall version).



# ↳ TETRAGONO

Anthracite Grey AS

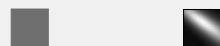

220/240Vac 50/60Hz  
electronic ballast  
included

MacAdam 2SDCM  
Life L70 (6K)>36300h  
CRI =90

IP65  
IK10

## TETRAGONO WALL

W	Weight	Beam	Flux	CCT
15 W	1,8 kg	AS	481 lm	3000K

Code
<b>T417300W00</b>

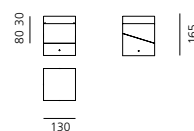

## TETRAGONO FLOOR 45

W	Weight	Beam	Flux	CCT
15 W	3,4 kg	AS	481 lm	3000K

Code
<b>T417100W00</b>

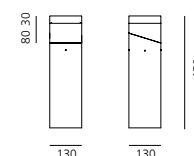

## TETRAGONO FLOOR 90

W	Weight	Beam	Flux	CCT
15 W	5,4 kg	AS	481 lm	3000K

Code
<b>T417200W00</b>

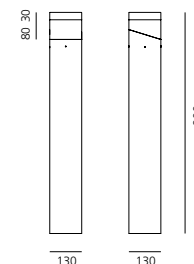

# Ippolito

Alessandro Pedretti  
(Studio Rota & Partners)

↪ 2011



## ↪ IPPOLITO

Anthracite Grey  
Light Grey

AS



Electronic ballast included.

MacAdam 2SDCM  
Life L70 (6K)=36300h  
CRI =90

IP65  
IK10

### IPPOLITO 45

W	Weight	Beam	Flux	CCT	Code
15 W	6,36 kg	AS	1137 lm	3000K	<b>T085100</b>

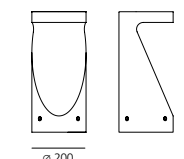
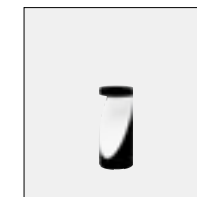

### IPPOLITO 90

W	Weight	Beam	Flux	CCT	Code
15 W	8,81 kg	AS	1212 lm	3000K	<b>T085000</b>

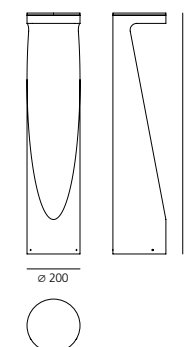

Light fixture with direct emission, with a unique high-performance monochromatic COB LED.

Floor installation.

Available in two heights (h 45cm and h 90cm).

Consists of support with lamp compartment and ballast compartment.

Cylindrical lamp support in engineering polymer (compact polyurethane). Painted with polyurethane resistant to atmospheric and chemical agents.

Fixture head in die-cast EN-AB 47100 aluminium, painted with 3-stage outdoor treatment: nanotechnologies, antioxidant primer, polyester paint.

UV resistant diffuser in transparent shock resistant polycarbonate.

Accessory compartment in polymers with closure cover in AISI 316.

Hot galvanised steel mounting plate, with holes for ground fixing by means of log bolts or dowels.

AISI 316 stainless steel screws and silicone seal gasket.

Provided with cable and IP68 connector for connection to the mains cables with 5 to 13,5 mm diameters.

Technical features of light fixtures in compliance with EN60598-1.



For further information on Ippolito  
↪ visit [artemide.com](http://artemide.com)

# Piroscafo

Ernesto Gismondi  
↪ 2014



Lighting appliance for ground fixing with directional light emission, using monochrome LED light sources.

The appliance consists of a body and a fixing base of EN-AB 47100 die-cast aluminium finished with a 3-stage outdoor treatment: nanotechnologies, anti-oxidising primer, polyester painting.



Shock-resistant tempered glass screen.

AISI 316 stainless steel screws and silicone seal gaskets.

Provided with cable and IP67 connector for connection to the mains. Supports cables with 7 to 12 mm diameters.

Technical specifications comply with the EN60598-1 norm.

## ↪ PIROSCAFO

Anthracite Grey 00	Rust 10	Green 20	AS 	220/240Vac 50/60Hz electronic ballast included	MacAdam 7SDCM Life L70 (6K)>36300h CRI = 80	IP65 
-----------------------	------------	-------------	---	--	---	---

W	Weight	Beam	Flux	CCT	Code
14 W	3,65 kg	AS	1143 lm	3000K	<b>T0819.</b> 00/10/20

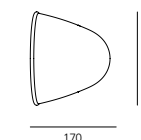
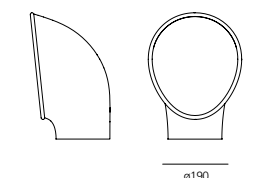

For further information on Piroscafo  
↪ visit [artemide.com](http://artemide.com)





# Oblique

Arik Levy  
↪ 2014

Series of direct-light appliances fitted with high-yield LED sources.

Floor, bollard, or wall fitting.

Available with 2 finishes: painted grey-white (RAL 9002) and charcoal grey.

Pre-treated with hard anodic oxide coating, for enhanced resistance to corrosion, and subsequent polyester painting.

The technical specifications of the appliances comply with EN60598-1.

Made up of lighting body, wall mount (wall version); lighting body, bollard available in two heights, floor fixing flange (bollard version.)

Accessories available for the wall version include: 250cm-high bollard; floor fixing peg.

EN-AB 471000 die-cast aluminium lighting body.

EN-AW-6060 aluminium extruded bollard.

Supplied with IP68 connector for connection with mains.



For further information on Oblique  
↪ visit [artemide.com](http://artemide.com)





↪ OBLIQUE

White □ 20	Anthracite Grey ■ 00	AS ■	220/240Vac 50/60Hz electronic ballast included	MacAdam 3SDCM Life L70 (6K)= 50000h CRI =80	IP65 ⊕ IK07
------------------	----------------------------	---------	--	---	-------------------

OBLIQUE BOLLARD 75

<b>W</b>	<b>Weight</b>	<b>Beam</b>	<b>Flux</b>	<b>CCT</b>	<b>Code</b>
15 W	4 kg	AS	750 lm	3000K	<b>T086300</b>

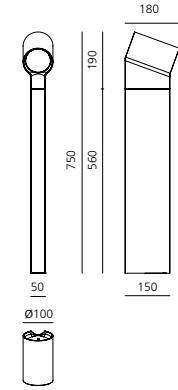

<b>Accessories</b>	<b>Code</b>
Ground picket	<b>T086500</b>

OBLIQUE BOLLARD 45

<b>W</b>	<b>Weight</b>	<b>Beam</b>	<b>Flux</b>	<b>CCT</b>	<b>Code</b>
15 W	4.3 kg	AS	750 lm	3000K	<b>T086200</b>

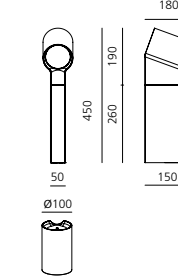

<b>Accessories</b>	<b>Code</b>
Ground picket	<b>T086500</b>

OBLIQUE

<b>W</b>	<b>Weight</b>	<b>Beam</b>	<b>Flux</b>	<b>CCT</b>	<b>Code</b>
20 W	2 kg	AS	918 lm	3000K	<b>T086020</b>

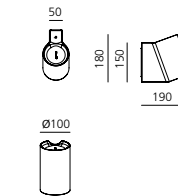

<b>Accessories</b>	<b>Code</b>
Ground picket	<b>T086500</b>
Pole	<b>T086400</b>



# Basolo

Ernesto Gismondi

↪ 2014

## ↪ BASOLO

Anthracite grey



AS XF



220/240Vac 50/60Hz  
electronic ballast included

MacAdam 2SDCM  
Life L70 (6K) >36000h  
CRI = 80

IP67  
IK06

### BASOLO WALLWASHER

W	Weight	Beam	Flux	CCT
27 W	3,4 kg	AS	2067 lm	3000K

**Fixed**  
Code  
**T419700W00**

**Mobile**  
Code  
**T440000W00**

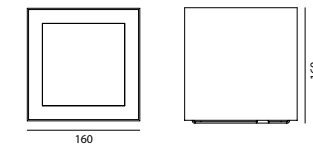

### BASOLO CEILING

W	Weight	Beam	Flux	CCT
27 W	3,4 kg	XF	2220 lm	3000K

**Code**  
**T440100W00**

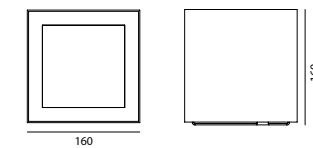

Floor and ceiling asymmetrical wallwasher light fixture with a roto-symmetrical option, only available for the ceiling version. The ceiling version is also available with downlight optics with high visual comfort (UGR<19).

Fixture consisting of cubic body and floor / ceiling fixing plate. Ceiling version includes a security cable, Wallwasher version also available in movable version .

Body made in die-cast aluminium EN-AB 44100 with 3-stage outdoor treatment: nanotechnologies, antioxidant primer, polyester paint.

Includes a metal-finish polycarbonate reflector.

Diffuser in tempered silk-screened glass.

AISI 316 fixing screws and silicon gaskets.

Supplied with H05RN-F 3X1 cable and IP67 network connector using 5-13.5 diameter cables, housed in a compartment in the lower part of the fixture.

Technical features in compliance to EN60598-1.



For further information on Basolo  
↪ visit [artemide.com](http://artemide.com)

# Cuneo Cuneo Mini

Klaus Begasse  
↔ 2010, 2015



The elliptical light emission and the flat shape of the fixture make it particularly suitable for floors or spacious areas in gardens to provide a side lighting.



For further information on Cuneo and Cuneo Mini  
↪ visit [artemide.com](http://artemide.com)

Light fixture with direct side emission, with high-performance LED light sources. Monochromatic LEDs are used together with collimators and a light-diffusing prismatic screen to obtain an optimum lighting beam.

Floor or wall installation. In the wall installation, the light can be pointed either upwards or downwards.

Available in 3 finishes: light grey, dark grey and rust painted.

Consists of lighting cap and terminal board fixed together by means of locking screws.

Cap and terminal board in die-cast EN AB-47100 aluminium, gaskets in silicone rubber. Electronic ballast integrated in the fixture.

Cuneo: PMMA collimators installed on the LED light sources. Light-diffusing prismatic screen in PMMA siliconed flush with the lighting cap.

Cuneo Mini: High-yield COB LED source with high-reflection anodized aluminium body. Etched tempered glass screen glued flush to the lighting body with silicon.

Power connection to the mains to be carried out outside the fixture, without the need to open, by means of a pre-installed IP65 connection device suitable for cables with a diameter between 6 and 13 mm.

Wall installation by means of a bracket in folded steel sheet to which the fixture is fastened with two screws.

Screws in AISI 316 stainless steel.



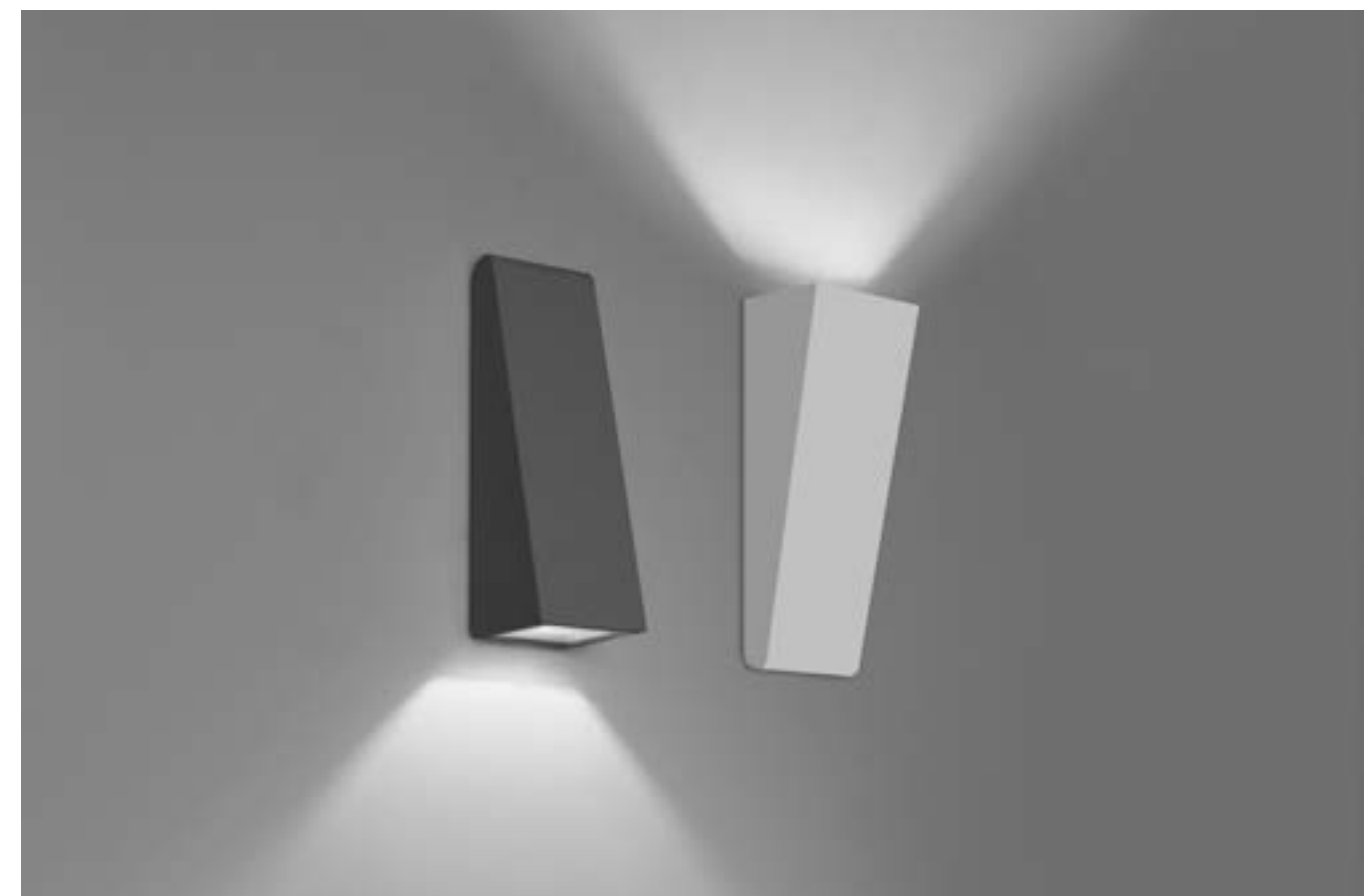

All the components in die-cast aluminium and the steel bracket for wall or floor fixing are painted by means of 3-stage outdoor treatment: nanotechnologies, antioxidant primer, polyester paint.

Technical features of light fixtures in compliance with EN60598-1.

ENEC approved.



↪ CUNEO, CUNEO MINI

Grey-white Ral 9002	Rust	Anthracite Grey	AS	220/240Vac 50/60Hz electronic ballast included	MacAdam 2SDCM Life L70 (6K)= 50000h CRI =90	IP65
						
00	10	20				

CUNEO

W	Weight	Beam	Flux	CCT	Code
17 W	1,8 kg	AS	595 lm	3000K	T0827. 00/10/20

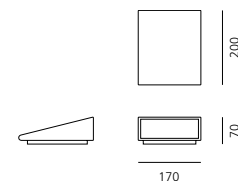
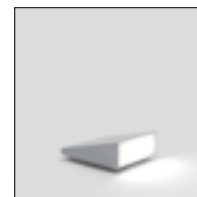

CUNEO MINI

W	Weight	Beam	Flux	CCT	Code
11 W	0,88 kg	AS	805 lm	3000K	T0828. 00/10/20

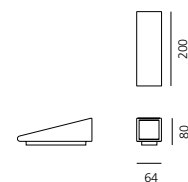



# Niki

Ernesto Gismondi

↪ 1999



↪ NIKI

Inox Satiny 15	Inox Polished 13	XF 	220/240Vac 50/60Hz electronic ballast included	MacAdam 3SDCM Life L70 (6K) 50000h CRI=80	IP65  IK06
-------------------	---------------------	---	--	---	---

W	Weight	Beam	CCT	Code
75 W	3 kg	XF	E27 3000K	AH100. 13/15

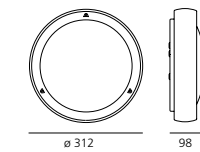
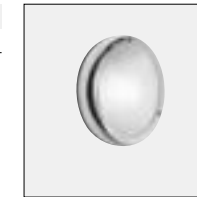

For further information on Niki  
↪ visit [artemide.com](http://artemide.com)

Light fixture with diffuse emission, with LED sources.  
Wall and ceiling installation.

Lamp unit in AISI316 stainless steel.

Moulded covering frame in AISI316 stainless steel, satiny or polished finish.

AISI 316 stainless steel screws and polyurethane seal gaskets.

Suitable for watertight connection.  
Electronic ballast.





# DioscURI

Michele De Lucchi

↪ 1999



red dot design award  
2000

DESIGN PLUS  
www.artemide.com

## ↪ DIOSCURI

White

XF

220/240Vac 50/60Hz  
electronic ballast  
included

IP65



Wall and ceiling light fixture with diffuse emission.  
Available in 4 sizes (ø14, ø25, ø35 e ø42 cm).  
Wall support in thermoplastic resin.  
Acid-etched blown glass diffuser, milk white colour.  
Silicone seal gaskets.  
Suitable for watertight connection.  
Technical features of light fixtures in compliance  
with EN60598-1.



For further information on DioscURI  
↪ visit [artemide.com](http://artemide.com)

### DIOSCURI 14

#### LED RETROFIT

W	IP
max 1x4W (E14)	44

Code
1039110A

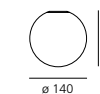

### DIOSCURI 25

#### LED RETROFIT

W	CCT
LED Retrofit max 1x8W (E27)	3000K

Code
0112010A

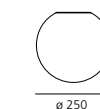

### DIOSCURI 35

#### LED RETROFIT

W	CCT
LED Retrofit max 1x21W (E27)	3000K

Code
0116010A

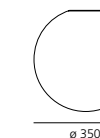

### DIOSCURI 42

#### LED RETROFIT

W	CCT
LED Retrofit max 1x21W (E27)	3000K

Code
0117010A

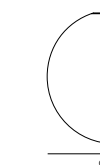

# Nuda

Ernesto Gismondi

↪ 2010

Series of light fixtures with direct unilateral or bilateral emission, with high-performance LED light sources.

Floor and recessed installation.

Available in 3 finishes: grey-white painted (RAL 9002), dark grey and rust painted.

Painting is obtained by means of 3-stage outdoor treatment: nanotechnologies, antioxidant primer, polyester paint.

AISI 316 stainless steel screws and silicone seal gasket.

Technical features of light fixtures in compliance with EN60598-1.

ENEC approved.

## Nuda floor

Available in unilateral and bilateral emission version and in two heights (h 50cm and h 100cm).

Consist of lamp, support pole and ground mounting plate.

Lamp unit in die-cast EN-AB 47100 aluminium.

UV resistant diffuser in shock resistant polycarbonate with satin finish.

Specular reflector in aluminium. It conveys and diffuses the luminous flow downwards to ensure visual comfort.

Support pole in extruded EN-AW-6060 aluminium, chromate treated and painted.

Mounting plate in folded, welded and painted steel, with holes for ground fixing by means of log bolts or dowels.

Provided with IP67 cable and connector for the mains connection.

## Nuda recessed

Consist of lamp and recessing box for recessed wall installation.

Lamp unit in painted die-cast EN-AB 44100 aluminium, complete with holding plate for electrical components.

Specular reflector in aluminium. It conveys and diffuses the luminous flow downwards to ensure visual comfort.

UV resistant diffuser in shock resistant polycarbonate with satin finish.

Aesthetic cover in painted aluminium.

Provided with IP67 cable and connector suitable for H07RN-F cables with a diameter from 5 to 13.5 mm for the mains connection.

Recessing box in reinforced polymer, can be ordered separately.



For further information on Nuda  
↪ visit [artemide.com](http://artemide.com)





**NUDA FLOOR 50 UNILATERAL**

LED 8,5 W			Lighting application		
h	L	a	Em	Emax	Emin
0.5 m	0.5 m	1.8 m	52 lux	178 lux	0.5 lux

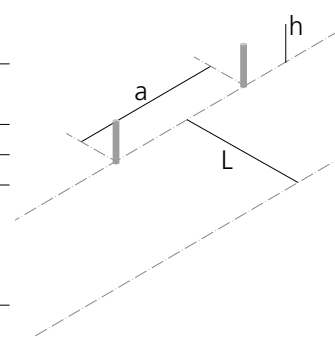

**NUDA FLOOR 100 UNILATERAL**

LED 17 W			Lighting application		
h	L	a	Em	Emax	Emin
1.0 m	1.0 m	2.5 m	24 lux	66 lux	0.5 lux



**NUDA FLOOR 50 BILATERAL**

LED 8,5 W			Lighting application		
h	L	a	Em	Emax	Emin
0.5 m	0.5 m	1.8 m	10 lux	59 lux	0.5 lux

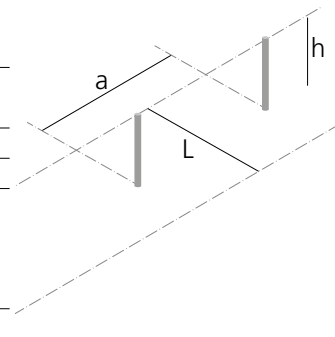





**NUDA FLOOR 100 BILATERAL**

LED 17 W			Lighting application		
h	L	a	Em	Emax	Emin
1.0 m	1.0 m	2.5 m	7 lux	26 lux	0.5 lux

-   
**RECESSED HOLE**  
 200 x 260 x 60 mm
-   
**RECESSING BOX**  
 190 x 250 x 55 mm
-   
**LIGHTING UNIT**
-   
**AESTHETIC COVER**





Grey-white Ral 9002	Rust	Anthracite Grey	AS	220/240Vac 50/60Hz electronic ballast included	MacAdam 7SDCM Life L70 (10K)>35500h CRI =80	IP65 IK06
 00	 10	 20				

NUDA RECESSED

W	Weight	Beam	Flux	CCT	Code
8 W	1,24 kg	AS	180 lm	3000K	<b>T0835.</b> 00/10/20

Recessing box **T083400**

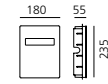

NUDA FLOOR 50 UNILATERAL

W	Weight	Beam	Flux	CCT	Code
8 W	3,6 kg	AS	180 lm	3000K	<b>T0836.</b> 00/10/20

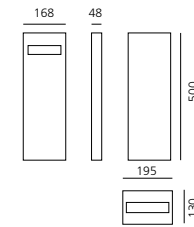

NUDA FLOOR 50 BILATERAL

W	Weight	Beam	Flux	CCT	Code
8 W	3,6 kg	AS	180 lm	3000K	<b>T0837.</b> 00/10/20

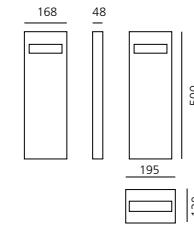

NUDA FLOOR 100 UNILATERAL

W	Weight	Beam	Flux	CCT	Code
17 W	5,21 kg	AS	306 lm	3000K	<b>T0838.</b> 00/10/20

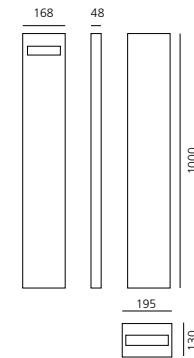
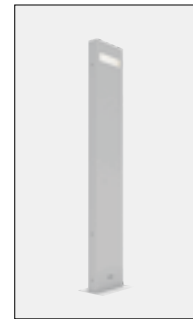

NUDA FLOOR 100 BILATERAL

W	Weight	Beam	Flux	CCT	Code
17 W	5,21 kg	AS	205 lm	3000K	<b>T0839.</b> 00/10/20

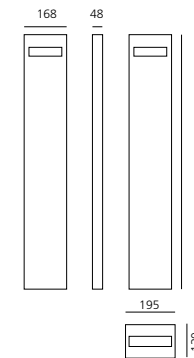
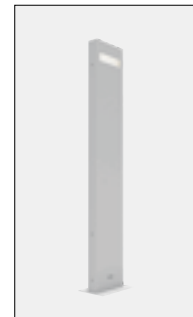

# Ciclope

Alessandro Pedretti  
(Studio Rota & Partners)

↪ 2009

Lighting system with diffuse unilateral or bilateral emission, with high-performance LED light sources.

Light emission is obtained by the combination of six monochromatic LED light sources, a reflector and an opaline diffuser.

Floor in unilateral and bilateral emission, wall or recessed installation.

Available in 3 finishes: light grey (RAL 9002), anthracite grey and rust painted.

Technical features of light fixtures in compliance with EN60598-1. ENEC approved.

Lighting unit consists of: frame in reinforced polymer; diffuser in light-diffusing polycarbonate; plate in pickled, machined and galvanised steel; watertight gasket in silicone rubber; LED circuit; electronic ballast; reflector in painted spun aluminium; PG13.5 cable gland, H05RN-F cable and IP65 electrical connection device suitable for cables with a diameter between 6 and 13 mm

to allow electrical interfacing with the external mains without the need to open the fixture.

The lighting unit houses the electrical components and sources.

Aesthetic cover in die-cast EN AB-47100 aluminium. The components in die-cast, extruded aluminium and steel are painted by means of 3-stage outdoor treatment: nanotechnologies, antioxidant primer, polyester paint.

The elements are fixed together by means of screws. All the locking screws used outside the fixture and inside the stem are in AISI 304 stainless steel.

Ciclope floor: available in two heights (h 50cm and h 90cm), stem in extruded EN AW-6060 aluminium. Ground mounting plate in folded, welded and painted steel, with holes for ground fixing by means of log bolts or dowels.

Ciclope recessed: recessing box in reinforced polymer, can be ordered separately.

Ciclope wall: box in extruded EN AW-6060 aluminium.



For further information on Ciclope  
↪ visit [artemide.com](http://artemide.com)



CICLOPE FLOOR 50 UNILATERAL

LED 6W			Lighting application		
h	L	a	Em	Emax	Emin
0.5 m	1.0 m	3 m	59 lux	378 lux	1 lux

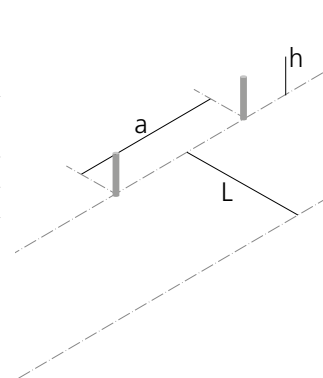

CICLOPE FLOOR 90 UNILATERAL/BILATERAL

LED 6W			Lighting application		
h	L	a	Em	Emax	Emin
0.9 m	1.0 m	3.5 m	28 lux	87 lux	1 lux

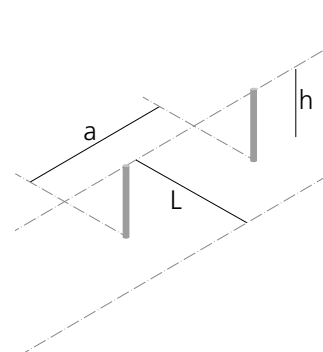
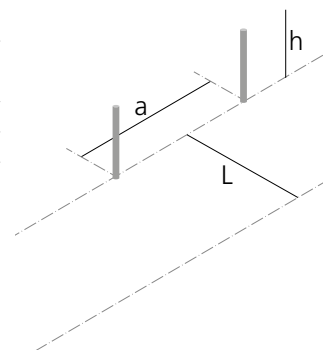

CICLOPE WALL/RECESSED

LED 6W			Lighting application		
h	L	a	Em	Emax	Emin
0.5 m	1.0 m	2.9 m	41 lux	281 lux	1 lux

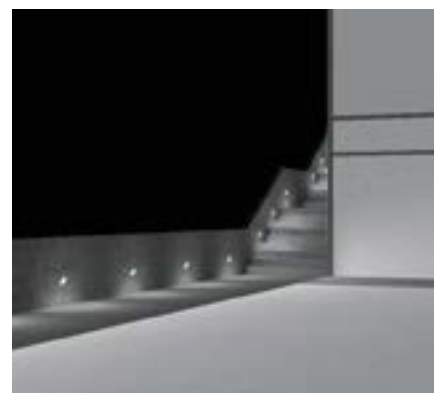
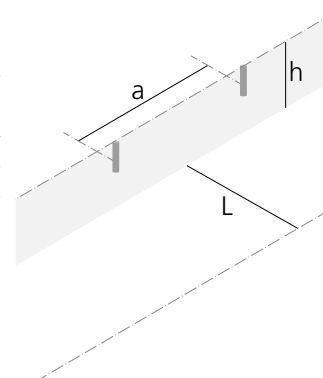

RECESSED HOLE  
230 x 330 x 50 mm



RECESSING BOX  
201 x 300 x 48,5 mm



LIGHTING UNIT



AESTHETIC COVER



## ↪ CICLOPE TERRA

Grey-white Ral 9002	Rust	Anthracite Grey	AS	220/240Vac 50/60Hz electronic ballast included	MacAdam 2SDCM Life L90 (20K)=118000h CRI =90	IP65 IK10
00	10	20		Mounting plate included		

### CICLOPE FLOOR 50 UNILATERAL

W	Weight	Beam	Flux	CCT	Code
7 W	4,5 kg	AS	383 lm	3000K	<b>T0810.</b> 00/10/20

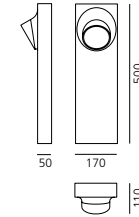

### CICLOPE FLOOR 50 BILATERAL

W	Weight	Beam	Flux	CCT	Code
13 W	4,5 kg	AS	765 lm	3000K	<b>T0813.</b> 00/10/20

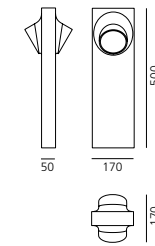

### CICLOPE FLOOR 90 UNILATERAL

W	Weight	Beam	Flux	CCT	Code
7 W	5,5 kg	AS	383 lm	3000K	<b>T0811.</b> 00/10/20

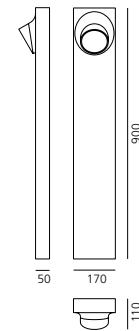

### CICLOPE FLOOR 90 BILATERAL

W	Weight	Beam	Flux	CCT	Code
13 W	5,5 kg	AS	765 lm	3000K	<b>T0814.</b> 00/10/20

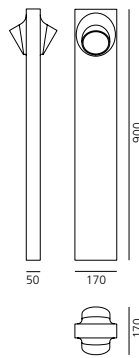

## ↪ CICLOPE PARETE

Grey-white Ral 9002	Rust	Anthracite Grey	AS	220/240Vac 50/60Hz electronic ballast included	MacAdam 2SDCM Life L90 (20K)=118000h CRI =90	IP65 IK10
00	10	20				

### CICLOPE RECESSED

W	Weight	Beam	Flux	CCT	Code
7 W	1,2 kg	AS	383 lm	3000K	<b>T0815.</b> 00/10/20

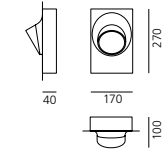

Recessing box

**T081600**

### CICLOPE WALL

W	Weight	Beam	Flux	CCT	Code
7 W	2 kg	AS	383 lm	3000K	<b>T0812.</b> 00/10/20

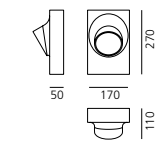

# Chilone

Ernesto Gismondi

↪ 2009

Series of light fixtures with direct emission, with high-performance LED light sources.

Floor, pole or wall installation.

Available in 3 finishes: light grey painted (RAL 9002), anthracite grey and rust painted.

Painting is obtained by means of 3-stage outdoor treatment: nanotechnologies, antioxidant primer, polyester paint.

AISI 316 stainless steel screws and silicone seal gasket.

Provided with IP67 cable and connector for the mains connection.

Technical features of light fixtures in compliance with EN60598-1.

ENEC approved.

Consists of lamp, lamp support and: wall support (Chilone wall), ground fixing pole (Chilone pole), ground mounting plate (Chilone floor).

Lamp unit in die-cast EN-AB 47100 aluminium.

UV resistant diffuser in shock resistant polycarbonate with satiny finish.

Lamp support in extruded EN-AW-6060 aluminium.

Chilone wall: it can be installed with the light pointed either downwards or upwards. Wall support in steel included.

Chilone pole: height 250 cm, ground fixing pole in painted extruded EN-AW-6060 aluminium. It must be installed by means of a proper foundation plinth.

Chilone floor: available with downward emission in two heights (h45cm and h 90cm) and with upward emission (Chilone Up). Support pole in extruded EN-AW-6060 aluminium, chromate treated and painted. Mounting plate in folded, welded and painted steel, with holes for ground fixing by means of log bolts or dowels.



For further information on Chilone  
↪ visit [artemide.com](http://artemide.com)



CHILONE FLOOR 45

LED 8 W			Lighting application		
h	L	a	Em	E <sub>max</sub>	E <sub>min</sub>
0.45 m	1.0 m	3.0 m	43 lux	842 lux	1 lux

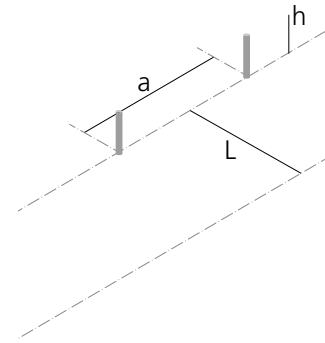

CHILONE FLOOR 90

LED 8 W			Lighting application		
h	L	a	Em	E <sub>max</sub>	E <sub>min</sub>
0.90 m	1.0 m	4.0 m	16 lux	96 lux	1 lux

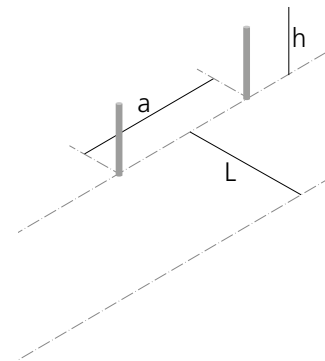

CHILONE POLE

LED 16 W			Lighting application		
h	L	a	Em	E <sub>max</sub>	E <sub>min</sub>
2.50 m	2.5 m	9 m	4 lux	9 lux	0.6 lux

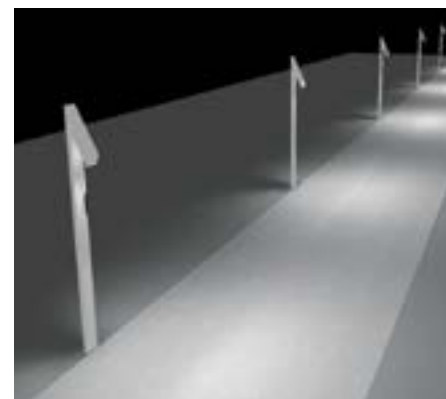
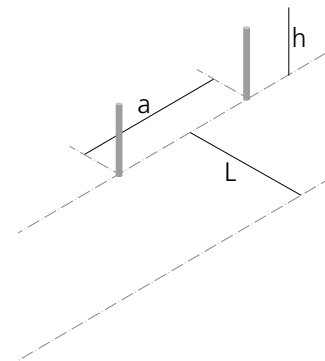



## ↪ CHILONE

Grey-white  
Ral 9002  
00

Rust  
10

Anthracite  
Grey  
20

AS

220/240Vac 50/60Hz  
electronic ballast  
included

MacAdam 7SDCM  
Life L70 (10K)>35500h  
CRI =80

IP65  
IK06

### CHILONE WALL

W	Weight	Beam	Flux	CCT	Code
16 W	3,81 kg	AS	515 lm	3000K	<b>T0824.</b> 00/10/20

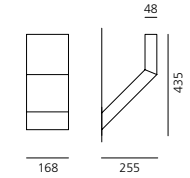
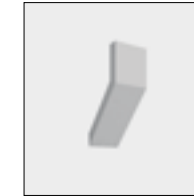

### CHILONE FLOOR 45

W	Weight	Beam	Flux	CCT	Code
8 W	3,98 kg	AS	194 lm	3000K	<b>T0822.</b> 00/10/20

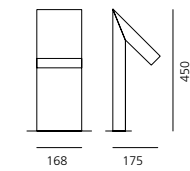

### CHILONE UP

W	Weight	Beam	Flux	CCT	Code
16 W	3,81 kg	AS	515 lm	3000K	<b>T0823.</b> 00/10/20

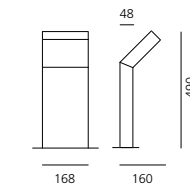

### CHILONE FLOOR 90

W	Weight	Beam	Flux	CCT	Code
8 W	5,27 kg	AS	194 lm	3000K	<b>T0821.</b> 00/10/20

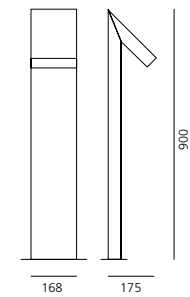

### CHILONE POLE

W	Weight	Beam	Flux	CCT	Code
16 W	10,65 kg	AS	310 lm	3000K	<b>T0820.</b> 00/10/20

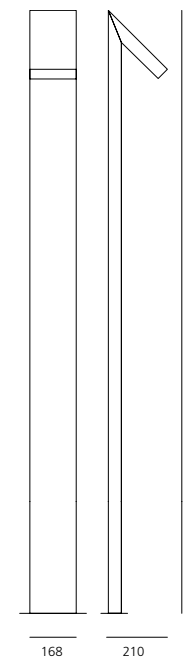
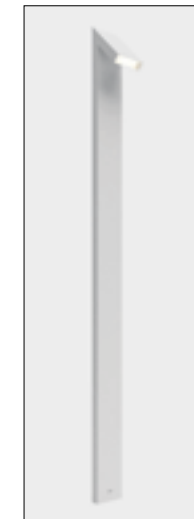



# Granito

Ernesto Gismondi

↪ 2010

Light fixture with metal halide sources.

The four light beams projected through the fissures on the sides make it particularly suitable for lighting drives or creating light effects in parks and gardens.

Available in two heights (h 30cm and h 60cm).

Available in 2 finishes: anthracite grey and Cor-ten (weathering steel).

Transparent sodium-calcium bulb protection glass.

Ground mounting plate in steel with 3-stage outdoor treatment: nanotechnologies, antioxidant primer, polyester paint.

AISI 316 stainless steel screws and silicone seal gaskets.

Electronic ballast.

Suitable for watertight connection.

Technical features of light fixtures in compliance with EN60598-1.

ENEC approved.



For further information on Granito  
↪ visit [artemide.com](http://artemide.com)



## ↪ GRANITO

Rust  
00

Anthracite Grey  
20

AS

220/240Vac 50/60Hz  
electronic ballast  
included

IP65  
IK10

### GRANITO 30

W  
METAL HALIDE 1x35W (G12) – HIT

Code  
T0830. 00  
20

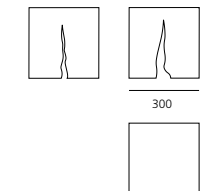

### GRANITO 60

W  
METAL HALIDE 1x35W (G12) – HIT

Code  
T0831. 00  
20

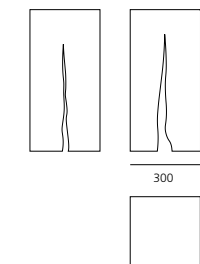

The colour of Cor-ten steel may change in time depending on weather conditions. Before stabilization, Cor-ten steel may release rust powder that may stain the surface where it is placed. Artemide recommends not to position it on sensitive surfaces, such as clear stones, marbles, etc.





# Calumet

Ernesto Gismondi  
↪ 2012



Lighting system with single or double emission, with high-performance LED light sources combined with lenses which optimize the light emitting efficiency of the beams and determine their spread.

Available in two sizes:  $\varnothing$  8 e  $\varnothing$  13 cm.

Ceiling and wall installation.

Available in two finishes: light grey and anthracite grey painted.

Wall version with single or double emission.

Consist of lighting body, lighting cap and wall fixing bracket / ceiling fixing flange (in EN AW-6060 aluminium)

Cylindrical body in EN AW-6060 aluminium containing the electronic power supply components.

Optical lighting body in EN AW-6060 aluminium.

Led and collimator lenses which swing by means of an aluminium bracket.

Diffuser in toughened glass.

Wall fixing bracket in bent steel.

Water tight silicone gaskets.

Electronic ballast integrated in the body.

PMMA lenses with narrow (wall-version) or wide (ceiling-version) beam.

Wall version: IP65 electrical connection device suitable for cables with a diameter between 6 and 13 mm and allowing the electrical interfacing with the external mains without need of opening the fixture.

Ceiling version: wiring to be made inside the fixture, by piercing a membrane fairlead IP65 suitable for of 6-13mm diameter cables.

All fixing dowels used outside the fixture are in AISI 304 stainless steel.

The components in die-cast aluminium and the steel bracket for wall fixing are painted by means of 3-stage outdoor treatment: nanotechnologies, antioxidant primer, polyester paint.

Technical features of light fixtures in compliance with EN60598-1.



For further information on Calumet  
↪ visit [artemide.com](http://artemide.com)

↪ CALUMET

Grey-white Ral 9002 00	Anthracite Grey 10	XS F 	220/240Vac 50/60Hz electronic ballast included	MacAdam 4SDCM CRI =80	IP65  IK06
------------------------------	--------------------------	----------	--	--------------------------	------------------

CALUMET 8 WALL

One emission					Code
W	Weight	Beam	Flux	CCT	
4 W	1,69 kg	7,8°	184 lm	3000K	<b>T41911NW.00/10</b>

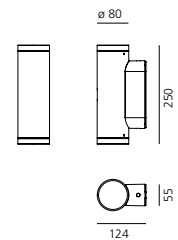

Double emission					Code
W	Weight	Beam	Flux	CCT	
7,5 W	1,69 kg	2x7,8°	369 lm	3000K	<b>T41922NW. 00/10</b>

CALUMET 13 WALL

One emission					Code
W	Weight	Beam	Flux	CCT	
7,5 W	3,8 kg	6°	366 lm	3000K	<b>T41941NW.00/10</b>

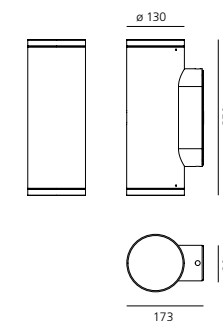

Double emission					Code
W	Weight	Beam	Flux	CCT	
15 W	3,8 kg	2x6°	732 lm	3000K	<b>T41952NW. 00/10</b>

CALUMET 8 CEILING

					Code
W	Weight	Beam	Flux	CCT	
4 W	1,69 kg	25°	189 lm	3000K	<b>T41931LW. 00/10</b>

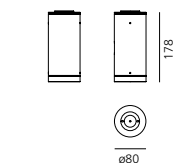
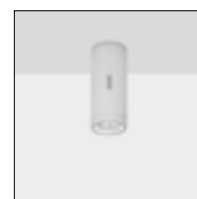

CALUMET 13 CEILING

					Code
W	Weight	Beam	Flux	CCT	
7,5 W	3,8 kg	38°	321 lm	3000K	<b>T41961LW. 00/10</b>

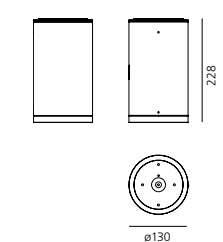



# Molla

Ernesto Gismondi  
↪ 2011

Light fixture with 2 combined light beams: the large one with lighting function and the narrow one with decorative function. Wall installation. The fixture can be installed with the main beam pointed either downwards or upwards according to the kind of lighting desired (direct or indirect).

The large beam is obtained by the combination of a monochromatic LED light source with a reflector. The narrow beam is obtained by the combination of a monochromatic LED light source with a high-performance projector.

Available in two finishes: light grey and anthracite grey painted.

Consists of lighting cap unit and terminal board fixed together by means of locking screws.

Cap and terminal board in die-cast EN AB-47100 aluminium.

Watertight gasket in silicone rubber.

Electronic ballast integrated in the fixture. Projector consists of a body in reinforced polymer and PMMA lenses.

Tempered and silkscreened light-diffusing glasses, siliconed flush with the lighting cap.

Power connection to the mains to be carried out outside the fixture, without the need to open it, by means of a pre-installed IP65 connection device suitable for cables with a diameter between 6 and 13 mm.

Wall fixing by means of a bracket in folded steel sheet to which the fixture is fastened with two screws.

Locking screws used outside the fixture in AISI 316 stainless steel.

Die-cast aluminium and bracket painted with 3-stage outdoor treatment: nanotechnologies, antioxidant primer, polyester paint.

Technical features of light fixtures in compliance with EN60598-1.



For further information on Molla  
↪ visit [artemide.com](http://artemide.com)

## ↪ MOLLA

Grey-white  
Ral 9002  
00

Anthracite  
Grey  
10

EL

220/240Vac 50/60Hz electronic ballast included

MacAdam 3SDCM  
CRI = 80

IP65

W	Weight	Beam	Flux	CCT	Code
14 W	2 kg	AS	407 lm	3000K	T4190NLW. 00/10

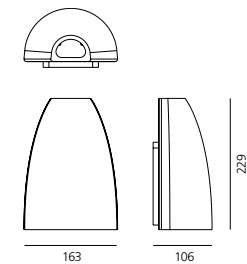

# Effetto

Ernesto Gismondi

↪ 2011

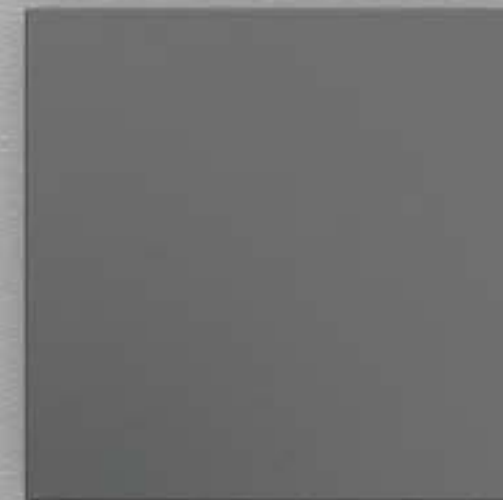

For further information on Effetto  
↪ visit [artemide.com](http://artemide.com)



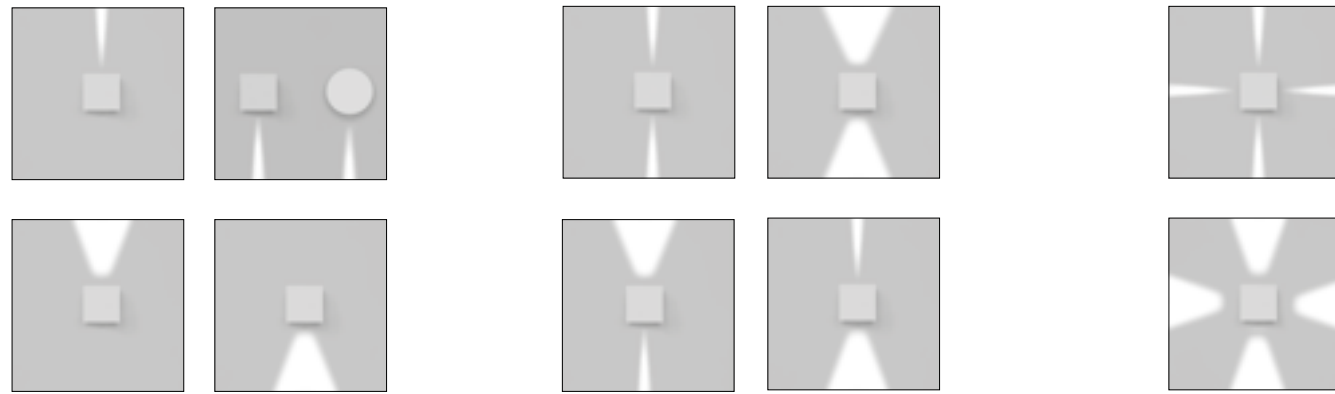

Light fixture with 1, 2 or 4 light beams using monochromatic LED light sources together with light-diffusing lenses which optimize the optical performance of the beams and establish their width. Designed to create geometric lights of scenic effect, it is available with beams of the same spread or with combined beams.

Beam spread  $2,6^\circ / 38^\circ$  (Effetto Round) and  $3,6^\circ / 46^\circ$  (Effetto Square).

Wall installation.

Available in two shapes: square and round and in two finishes: grey-white painted and rust painted.

Consists of lighting cap unit and terminal board fixed together by means of locking dowels.

Cap in die-cast EN AB-47100 aluminium.

Terminal board in reinforced polymer.

Watertight gasket in silicone rubber.

Electronic ballast integrated in the fixture.

PMMA lenses siliconed flush with the cap to obtain two different beam angle opening (narrow and wide).

Wiring to be carried out inside the terminal board by piercing an IP65 membrane grommet suitable for cables with a diameter of 6-13 mm.

Locking dowels used outside the fixture in AISI 316 stainless steel.

Painted die-cast aluminium with 3-stage outdoor treatment: nanotechnologies, antioxidant primer, polyester paint.

Technical features of light fixtures in compliance with EN60598-1.

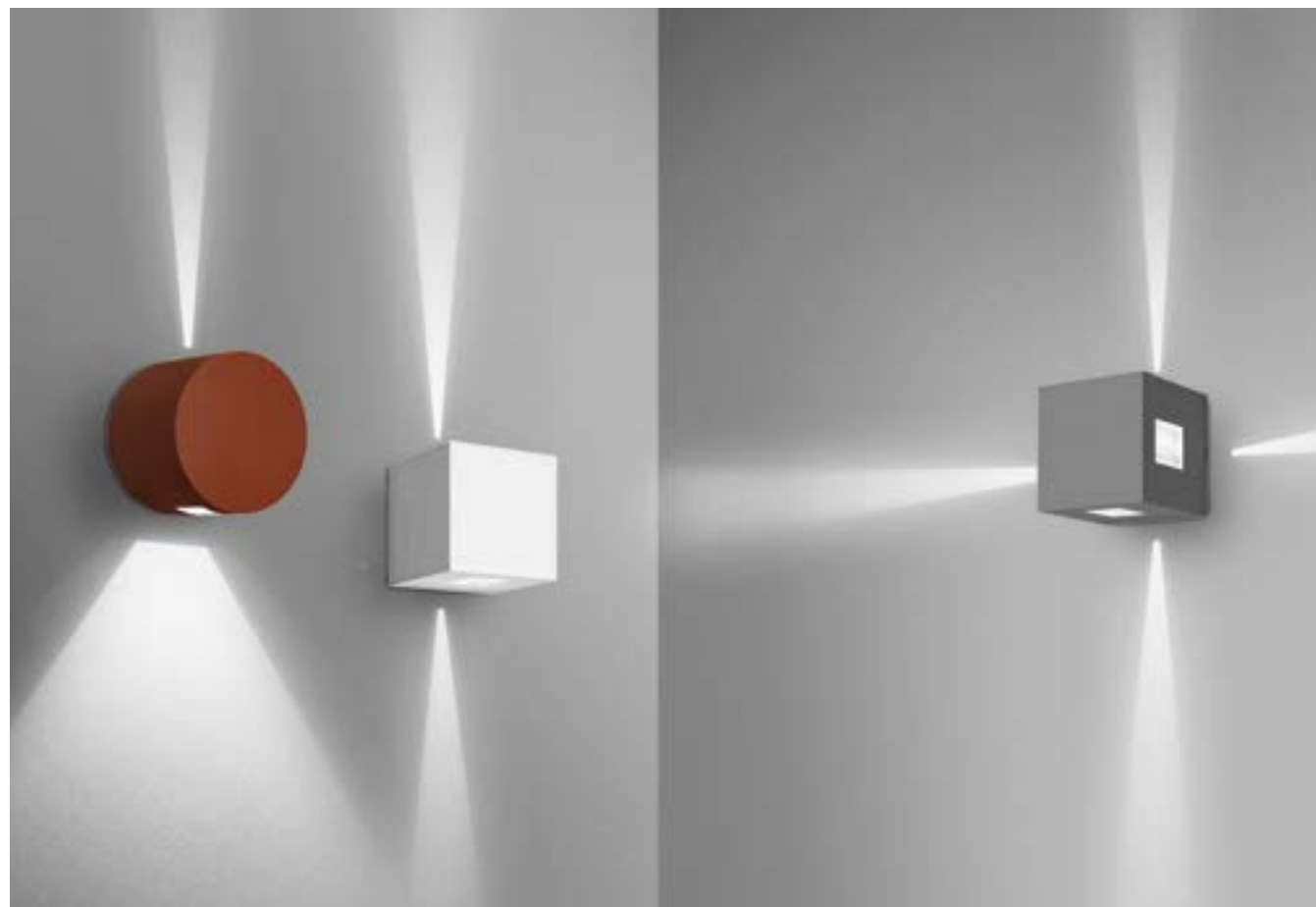

↪ EFFETTO

Grey-white Ral 9002 00    Rust 10    Anthracite Grey 20    XS    WF    XF    220/240Vac 50/60Hz electronic ballast included.    MacAdam 4SDCM Life L70 (9K)> 51400h CRI =80    IP65 IK10

**1 narrow beam**

W	Weight	Beam Square	Beam Round	Flux Square	Flux Round	CCT	Square Code	Round Code
4,5 W	2,5 kg	1x3,6°	1x3,6°	19 lm	23,5 lm	3000 K	<b>T42021NW.</b> 00/10/20	<b>T42121NW.</b> 00/10/20

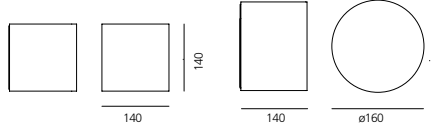
**1 large beam**

W	Weight	Beam Square	Beam Round	Flux Square	Flux Round	CCT	Square Code	Round Code
4,5 W	2,5 kg	1x4,6°	1x4,6°	54,50 lm	50 lm	3000 K	<b>T42021LW.</b> 00/10/20	<b>T42121LW.</b> 00/10/20

**2 narrow beams**

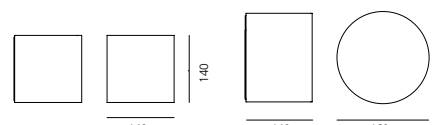
W	Weight	Beam Square	Beam Round	Flux Square	Flux Round	CCT	Square Code	Round Code
7 W	2,5 kg	2x 3,6°	2x 3,6°	37,6 lm	49,34 lm	3000 K	<b>T42012NW.</b> 00/10/20	<b>T42112NW.</b> 00/10/20

**1 narrow beam 1 large beam**

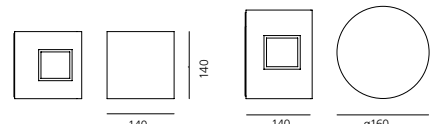
W	Weight	Beam Square	Beam Round	Flux Square	Flux Round	CCT	Square Code	Round Code
7 W	2,5 kg	1x 3,6°+ 1x 46°	1x 3,6°+ 1x 46°	73,32 lm	73,36 lm	3000 K	<b>T4201NLW.</b> 00/10/20	<b>T4211NLW.</b> 00/10/20



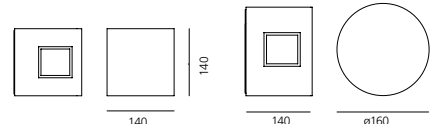

↪ EFFETTO

Grey-white Ral 9002 00    Rust 10    Anthracite Grey 20    XS    WF    XF    220/240Vac 50/60Hz electronic ballast included.    MacAdam 4SDCM Life L70 (9K)> 51400h CRI =80    IP65 IK10

**2 large beams**

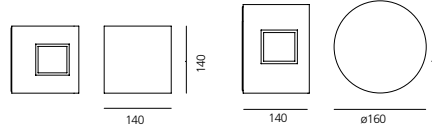
W	Weight	Beam Square	Beam Round	Flux Square	Flux Round	CCT	Square Code	Round Code
7 W	2,5 kg	2x46°	2x46°	109 lm	99,8 lm	3000 K	<b>T42012LW.</b> 00/10/20	<b>T42112LW.</b> 00/10/20

**4 narrow beams**

W	Weight	Beam Square	Beam Round	Flux Square	Flux Round	CCT	Square Code	Round Code
11 W	2,5 kg	4x 3,6°	4x 3,6°	76,1 lm	102 lm	3000 K	<b>T42004NW.</b> 00/10/20	<b>T42104NW.</b> 00/10/20

**4 large beams**

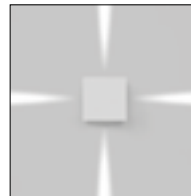
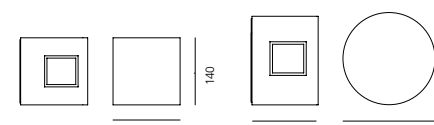
W	Weight	Beam Square	Beam Round	Flux Square	Flux Round	CCT	Square Code	Round Code
11 W	2,5 kg	4x 46°	4x 46°	218 lm	204 lm	3000 K	<b>T42004LW.</b> 00/10/20	<b>T42104LW.</b> 00/10/20

# Tolomeo XXL

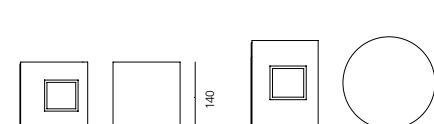
Michele De Lucchi, Giancarlo Fassina

↪ 2009



Light fixture with direct emission, with fluorescent or LED.

Available with base or fixed support (pivot) made of mass-coloured concrete.

Diffuser in mass-pigmented polypropylene, screen in light-diffusing silkscreened methacrylate, reflector in painted aluminium.

Mobile-arm structure in extruded EN-AW-6060 aluminium with bright anodizing treatment.

Polished-painted articulations in die-cast EN-AB 46100 aluminium.

Adjustment system in AISI 316 stainless steel.

Silicone seal gaskets.

Suitable for watertight connection.

Electronic ballast.

Technical features of light fixtures in compliance with EN60598-1.

ENEC approved.



For further information on Vector  
↪ visit [artemide.com](http://artemide.com)



↪ TOLOMEO XXL

Silver Grey 00	XF	220/240Vac 50/60Hz electronic ballast included	MacAdam 3SDCM Life L70 (6K)=50000h CRI =90	IP65 30° base/90° perno
-------------------	----	--	--	----------------------------

TOLOMEO XXL WITH BASE

LED				Code
W	Beam	Flux	CCT	
55 W	XF	4774 lm	3000K	<b>1532150A</b>

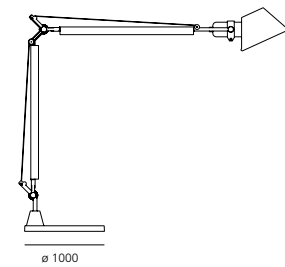

min 2273 - max 3519

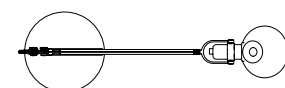

TOLOMEO XXL WITH FIXED SUPPORT

LED				Code
W	Beam	Flux	CCT	
55 W	XF	4774 lm	3000K	<b>1535150A</b>

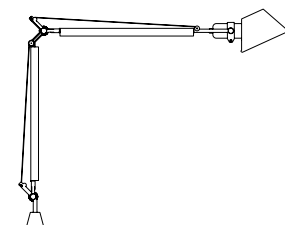

min 2273 - max 3519

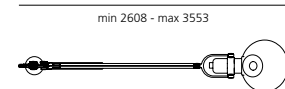

# Tolomeo Outdoor

Michele De Lucchi, Giancarlo Fassina

↪ 2015

Floor, suspension, and hook, as well as lampshade and lamppost versions, made with materials and finishes suited for outdoor use.

The LED source is contained within a diffusing cap fitted inside a clear IP65 plastic element.

The suspension version has protection rating IP65, whereas the floor and hook versions have protection rating IP44.

All the versions of Tolomeo Outdoor are available with or without lampshade.

The frames with lighting body of the lamppost and lampshade versions have different features.

Tolomeo Outdoor Paralume





For further information on Tolomeo Outdoor  
↪ visit [artemide.com](http://artemide.com)

Tolomeo Outdoor Lampione



## ↪ TOLOMEO OUTDOOR PARALUME

Structure Aluminium	White	Dove Grey	Black	XF	MacAdam 3SDCM Life L70 (6K)=50000h CRI =80	IP44/ IP65
	30	40	50			

### TOLOMEO OUTDOOR PARALUME FLOOR

W	Weight	Beam	Flux	CCT
20 W	3,8 kg	XF	815 lm	3000K
Base + rod				
Diffuser ø52				

Code
<b>T076100</b>
<b>T076300</b>
<b>T0773.</b> 30/40/50



IP44

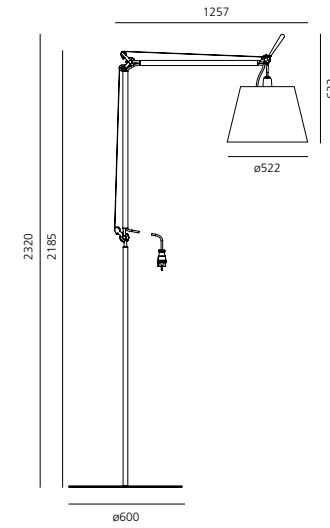

### TOLOMEO OUTDOOR PARALUME SUSPENSION

W	Weight	Beam	Flux	CCT
20 W	2 kg	XF	815 lm	3000K
Diffuser ø52				

Code
<b>T076000</b>
<b>T0773.</b> 30/40/50



IP65

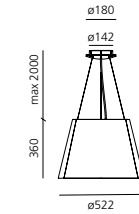

### TOLOMEO OUTDOOR PARALUME HOOK

W	Weight	Beam	Flux	CCT
20 W	2 kg	XF	815 lm	3000K
Diffuser ø52				

Code
<b>T076500</b>
<b>T0773.</b> 30/40/50



IP44

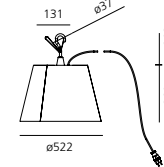

## ↪ TOLOMEO OUTDOOR LAMPIONE

Structure Aluminium		XF	MacAdam 3SDCM Life L70 (6K)=50000h CRI =80	IP44/ IP65

### TOLOMEO OUTDOOR LAMPIONE FLOOR

W	Weight	Beam	Flux	CCT
20 W	4,6 kg	XF	1613 lm	3000K
Base + rod				

Code
<b>T078100</b>
<b>T076300</b>



IP44

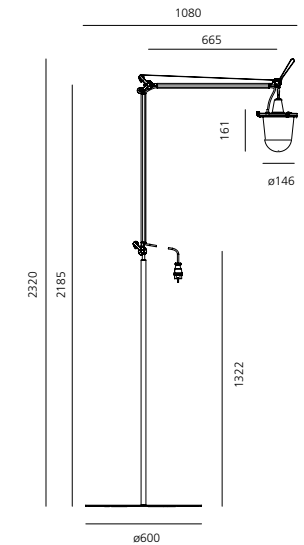

### TOLOMEO OUTDOOR LAMPIONE SUSPENSION

W	Weight	Beam	Flux	CCT
20 W	2 kg	XF	1613 lm	3000K

Code
<b>T078000</b>



IP65

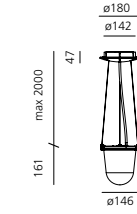

### TOLOMEO OUTDOOR LAMPIONE HOOK

W	Weight	Beam	Flux	CCT
20 W	2 kg	XF	1613 lm	3000K

Code
<b>T078500</b>



IP44

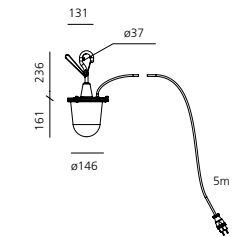





# Downlighting Walk over Drive over

↳



Ego downlight _____	798
Ego walk over / drive over _____	816
Megara _____	834
Microled _____	842
Aria _____	844
Faci _____	848
Faci Vetro _____	852



# Ego downlight

↳ 2012

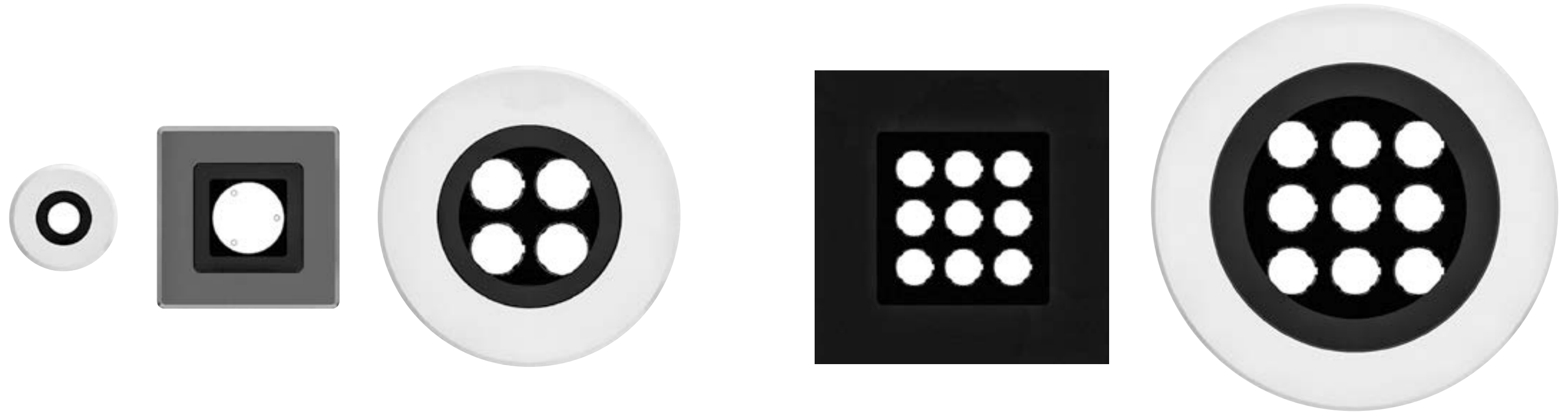

# Ego downlight typologies



Ego 55 downlight  
Recessed depth 94 mm



∅ 47 ±1 mm



max 35 mm

Ego 55 downlight  
Recessed depth 60 mm



∅ 47 ±1 mm



max 40 mm

Ego 90 downlight  
Recessed depth 90 mm



∅ 80 ±2 mm



max 35 mm

Ego 90 downlight  
Recessed depth 60 mm



∅ 80 ±2 mm



max 35 mm

Ego 150 downlight  
Recessed depth 120 mm



∅ 135 ±2 mm



□ 135 ±2 mm



max 40 mm

Ego 150 downlight  
Recessed depth 60 mm



∅ 135 ±2 mm



□ 135 ±2 mm



max 40 mm

Ego 220 downlight  
Recessed depth 117 mm



∅ 203 ±2 mm



□ 203 ±2 mm



max 40 mm

Ego 220 downlight  
Recessed depth 60 mm



∅ 203 ±2 mm



□ 203 ±2 mm



max 35 mm

Remote ballast  
supplied separately.  
(Ego Flat, Ego 55-90)

Lighting unit  
with built-in springs.

Round or square frame in aluminium  
or stainless steel.  
Silkscreened tempered glass.

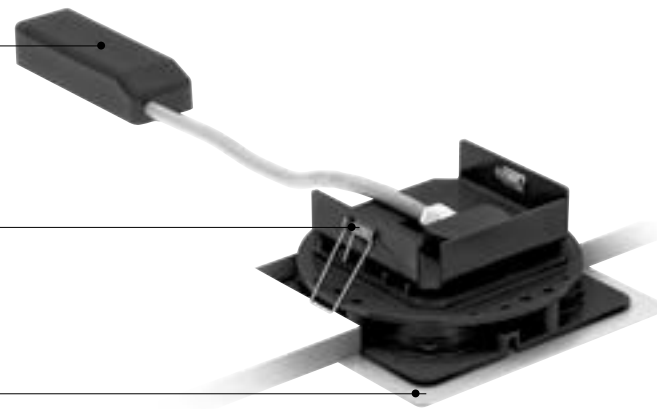

Light fixture with high-performance LED light sources.

Ceiling installation.

Two different housing depths.

Round and square version in five sizes.

Consists of body, frame, glass diffuser, fixing springs (Ego Flat and Ego 55-90), fixing brackets (Ego 150-220-320).

Body in EN AB-44100 aluminium, silicone gaskets.

Frame in aluminium or stainless steel AISI 316.

Black silkscreened tempered glass, 8mm-thick.

Fixing springs in harmonic iron.

Power connection to the mains by means of a H05RN-r cable and IP68 electrical terminal board, supplied with the fixture.

Glass surface temperature lower than 40°C.

Fixed and adjustable optics. PMMA lenses in 3 different versions of beams.

Painted die-cast aluminium with 3-stage outdoor treatment: nanotechnologies, anti-oxidant primer, polyester paint.

Technical features of light fixtures in compliance with EN60598-1 and part 2-13.



For further information on Ego Downlight  
visit [artemide.com](http://artemide.com)



## ↳ EGO 55 DOWNLIGHT ROUND

Aluminium IK09 Stainless steel IK10

XS WF EL

Electronic ballast 24V SELV supplied separately

MacAdam 4SDCM Life L90 (9K) >54400h CRI = 80

IP65/ IP67

Fixed beam

### EGO 55 DOWNLIGHT ROUND

Aluminium IK09						Stainless steel IK10					
W	CRI	Weight	Beam	Flux	CCT	Code	Code	Code	Code	Code	Code
1,5 W	=80	0,28 kg	14°	83 lm	3000K	<b>T4081SPW00</b>	<b>T4080SPW00</b>				
			32°	76 lm	3000K	<b>T4081WFLW00</b>	<b>T4080WFLW00</b>				
			EL	78 lm	3000K	<b>T4081ELPTW00</b>	<b>T4080ELPTW00</b>				

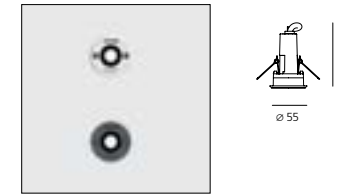

∅ 47±1 max 35 mm

Driver	24W IP67	DALI	185x35x33mm	<b>DV1041</b>
Driver	25 W IP67		148x40x32mm	<b>T409996</b>
Driver	60 W IP67		163x43x32mm	<b>T409998</b>
Driver	90 W IP67		161x61x36mm	<b>T409999</b>

Verify driver / recessed hole's dimensions.  
Please see page 945 for drivers installation details.

## ↳ EGO 55 DOWNLIGHT SQUARE

Aluminium IK09 Stainless steel IK10

XS WF EL

Electronic ballast 24V SELV supplied separately

MacAdam 4SDCM Life L90 (9K) >54400h CRI = 80

IP65/ IP67

Fixed beam

### EGO 55 DOWNLIGHT SQUARE

Aluminium IK09						Stainless steel IK10					
W	CRI	Weight	Beam	Flux	CCT	Code	Code	Code	Code	Code	Code
1,5 W	=80	0,52 kg	14°	83 lm	3000K	<b>T4061SPW00</b>	<b>T4060SPW00</b>				
			32°	76 lm	3000K	<b>T4061WFLW00</b>	<b>T4060WFLW00</b>				
			EL	78 lm	3000K	<b>T4061ELPTW00</b>	<b>T4060ELPTW00</b>				

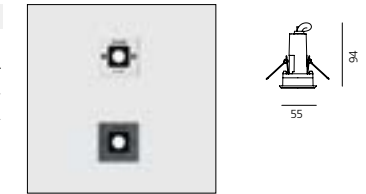

∅ 47±1 max 35 mm

Driver	24W IP67	DALI	185x35x33mm	<b>DV1041</b>
Driver	25 W IP67		148x40x32mm	<b>T409996</b>
Driver	60 W IP67		163x43x32mm	<b>T409998</b>
Driver	90 W IP67		161x61x36mm	<b>T409999</b>

Verify driver / recessed hole's dimensions.  
Please see page 945 for drivers installation details.

## EGO 55 FLAT DOWNLIGHT ROUND

Aluminium IK09						Stainless steel IK10					
W	CRI	Weight	Beam	Flux	CCT	Code	Code	Code	Code	Code	Code
1 W	=80	0,39 kg	14°	83 lm	3000K	<b>T42001SPW00</b>	<b>T42009SPW00</b>				
			32°	76 lm	3000K	<b>T42001WFLW00</b>	<b>T42009WFLW00</b>				
			EL	78 lm	3000K	<b>T42001ELPTW00</b>	<b>T42009ELPTW00</b>				

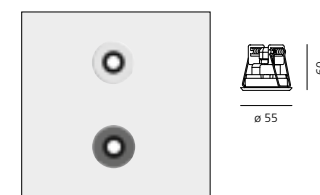

∅ 47±1 max 40 mm

Electronic ballast 350mA SELV supplied separately

Driver	V(ac)	L x W x H(mm)	IP	N.max	DIM	Code
cc 14W 350mA	220-240	79 x 38 x 25	67	4	-	<b>DV3001</b>
cc 23W 350mA	220-240	185 x 35 x 33	67	5	DALI	<b>DV1042</b>

Verify driver / recessed hole's dimensions.

## EGO 55 FLAT DOWNLIGHT SQUARE

Aluminium IK09						Stainless steel IK10					
W	CRI	Weight	Beam	Flux	CCT	Code	Code	Code	Code	Code	Code
1 W	=80	0,39 kg	14°	83 lm	3000K	<b>T42002SPW00</b>	<b>T42010SPW00</b>				
			32°	76 lm	3000K	<b>T42002WFLW00</b>	<b>T42010WFLW00</b>				
			EL	78 lm	3000K	<b>T42002ELPTW00</b>	<b>T42010ELPTW00</b>				

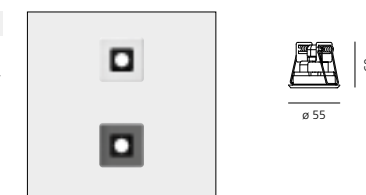

∅ 47±1 max 40 mm

Electronic ballast 350mA SELV supplied separately

Driver	V(ac)	L x W x H(mm)	IP	N.max	DIM	Code
cc 14W 350mA	220-240	79 x 38 x 25	67	4	-	<b>DV3001</b>
cc 23W 350mA	220-240	185 x 35 x 33	67	5	DALI	<b>DV1042</b>

Verify driver / recessed hole's dimensions.

## ↪ EGO 90 DOWNLIGHT ROUND

Aluminium IK09 Stainless steel IK10 XS WF EL Electronic ballast 24V SELV supplied separately MacAdam 4SDCM Life L90 (9K) >54400h CRI = 80 IP65/ IP67

### EGO 90 DOWNLIGHT ROUND

Aluminium IK10						Stainless steel IK10											
W	CRI	Weight	Beam	Flux	CCT	Code						Code					
3 W	=80	0,50 kg	10°	220 lm	3000K	<b>T4083SPW00</b>						<b>T4082SPW00</b>					
			24°	179 lm	3000K	<b>T4083FLW00</b>						<b>T4082FLW00</b>					
			EL	162 lm	3000K	<b>T4083ELPTW00</b>						<b>T4082ELPTW00</b>					

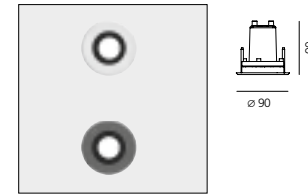

∅ 80±2  
max 35 mm

Driver	24W IP67	DALI	185x35x33mm	<b>DV1041</b>
Driver	25 W IP67		148x40x32mm	<b>T409996</b>
Driver	60 W IP67		163x43x32mm	<b>T409998</b>
Driver	90 W IP67		161x61x36mm	<b>T409999</b>

Verify driver / recessed hole's dimensions.  
Please see page 945 for drivers installation details.

## ↪ EGO 90 DOWNLIGHT SQUARE

Aluminium IK09 Stainless steel IK10 XS WF EL Electronic ballast 24V SELV supplied separately MacAdam 4SDCM Life L90 (9K) >54400h CRI = 80 IP65/ IP67

### EGO 90 DOWNLIGHT SQUARE

Aluminium IK10						Stainless steel IK10											
W	CRI	Weight	Beam	Flux	CCT	Code						Code					
3 W	=80	0,50 kg	10°	220 lm	3000K	<b>T4063SPW00</b>						<b>T4062SPW00</b>					
			24°	179 lm	3000K	<b>T4063FLW00</b>						<b>T4062FLW00</b>					
			EL	162 lm	3000K	<b>T4063ELPTW00</b>						<b>T4062ELPTW00</b>					

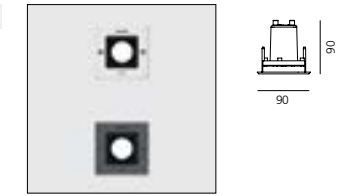

∅ 47±2  
max 35 mm

Driver	24W IP67	DALI	185x35x33mm	<b>DV1041</b>
Driver	25 W IP67		148x40x32mm	<b>T409996</b>
Driver	60 W IP67		163x43x32mm	<b>T409998</b>
Driver	90 W IP67		161x61x36mm	<b>T409999</b>

Verify driver / recessed hole's dimensions.  
Please see page 945 for drivers installation details.

## EGO 90 FLAT DOWNLIGHT ROUND

Aluminium IK10						Stainless steel IK10											
W	CRI	Weight	Beam	Flux	CCT	Code						Code					
3 W	=80	0,52 kg	10°	220 lm	3000K	<b>T42003SPW00</b>						<b>T42011SPW00</b>					
			24°	179 lm	3000K	<b>T42003FLW00</b>						<b>T42011FLW00</b>					
			EL	162 lm	3000K	<b>T42003ELPTW00</b>						<b>T42011ELPTW00</b>					

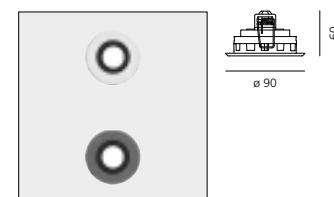

∅ 80±2  
max 35 mm

Electronic ballast 350mA SELV supplied separately

Driver	V(ac)	L x W x H(mm)	IP	N.max	DIM	
cc 14W 350mA	220-240	79 x 38 x 25	67	4	-	<b>DV3001</b>
cc 23W 350mA	220-240	185 x 35 x 33	67	5	DALI	<b>DV1042</b>

Verify driver / recessed hole's dimensions.

## EGO 90 FLAT DOWNLIGHT SQUARE

Aluminium IK10						Stainless steel IK10											
W	CRI	Weight	Beam	Flux	CCT	Code						Code					
3 W	=80	0,52 kg	10°	220 lm	3000K	<b>T42004SPW00</b>						<b>T42012SPW00</b>					
			24°	179 lm	3000K	<b>T42004FLW00</b>						<b>T42012FLW00</b>					
			EL	162 lm	3000K	<b>T42004ELPTW00</b>						<b>T42012ELPTW00</b>					

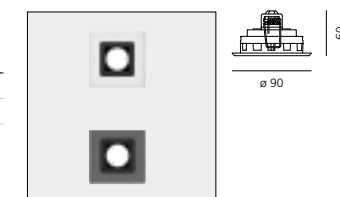

∅ 80±2  
max 35 mm

Electronic ballast 350mA SELV supplied separately

Driver	V(ac)	L x W x H(mm)	IP	N.max	DIM	
cc 14W 350mA	220-240	79 x 38 x 25	67	4	-	<b>DV3001</b>
cc 23W 350mA	220-240	185 x 35 x 33	67	5	DALI	<b>DV1042</b>

Verify driver / recessed hole's dimensions.

## ↳ EGO 150 DOWNLIGHT ROUND



### EGO 150 DOWNLIGHT ROUND

						Aluminium IK09		Stainless steel IK09	
W	CRI	Weight	Beam	Flux	CCT	Code		Code	
8 W	=80	1,3 kg	5°	366 lm	3000K	<b>T4085NSPW00</b>		<b>T4084NSPW00</b>	
			38°	321 lm	3000K	<b>T4085WFLW00</b>		<b>T4084WFLW00</b>	
			EL	366 lm	3000K	<b>T4085ELPTW00</b>		<b>T4084ELPTW00</b>	

220/240Vac 50/60Hz electronic ballast included

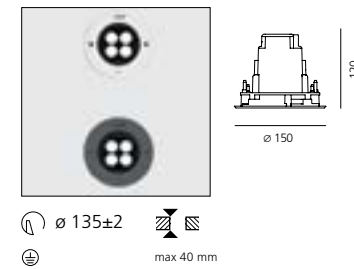

## ↳ EGO 150 DOWNLIGHT SQUARE



### EGO 150 DOWNLIGHT SQUARE

						Aluminium IK09		Stainless steel IK09	
W	CRI	Weight	Beam	Flux	CCT	Code		Code	
8 W	=80	1,35 kg	5°	366 lm	3000K	<b>T4065NSPW00</b>		<b>T4064NSPW00</b>	
			38°	321 lm	3000K	<b>T4065WFLW00</b>		<b>T4064WFLW00</b>	
			EL	366 lm	3000K	<b>T4065ELPTW00</b>		<b>T4064ELPTW00</b>	

220/240Vac 50/60Hz electronic ballast included

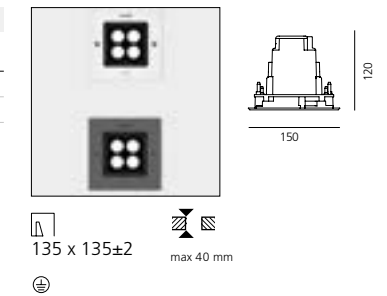

## EGO 150 FLAT DOWNLIGHT ROUND

						Aluminium IK09		Stainless steel IK09	
W	CRI	Weight	Beam	Flux	CCT	Code		Code	
6 W	=80	0,88 kg	5°	366 lm	3000K	<b>T42005NSPW00</b>		<b>T42013NSPW00</b>	
			38°	321 lm	3000K	<b>T42005WFLW00</b>		<b>T42013WFLW00</b>	
			EL	366 lm	3000K	<b>T42005ELPTW00</b>		<b>T42013ELPTW00</b>	

Electronic ballast 500mA SELV supplied separately

Driver	V(ac)	L x W x H(mm)	IP	N.max	DIM	
cc 14W 500mA	220-240	79 x 38 x 25	67	2	-	<b>DV3002</b>
cc 28W 500mA	220-240	120 x 38 x 25	67	2-3	-	<b>DV1039</b>
cc 31W 500mA	220-240	185 x 35 x 33	67	3	DALI	<b>DV1042</b>

Verify driver / recessed hole's dimensions.

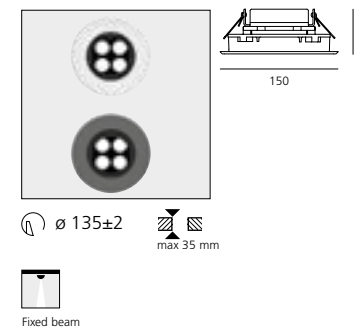

## EGO 150 FLAT DOWNLIGHT SQUARE

						Aluminium IK09		Stainless steel IK09	
W	CRI	Weight	Beam	Flux	CCT	Code		Code	
6 W	=80	0,88 kg	5°	366 lm	3000K	<b>T42006NSPW00</b>		<b>T42014NSPW00</b>	
			38°	321 lm	3000K	<b>T42006WFLW00</b>		<b>T42014WFLW00</b>	
			EL	366 lm	3000K	<b>T42006ELPTW00</b>		<b>T42014ELPTW00</b>	

Electronic ballast 500mA SELV supplied separately

Driver	V(ac)	L x W x H(mm)	IP	N.max	DIM	
cc 14W 500mA	220-240	79 x 38 x 25	67	2	-	<b>DV3002</b>
cc 28W 500mA	220-240	120 x 38 x 25	67	2-3	-	<b>DV1039</b>
cc 31W 500mA	220-240	185 x 35 x 33	67	3	DALI	<b>DV1042</b>

Verify driver / recessed hole's dimensions.

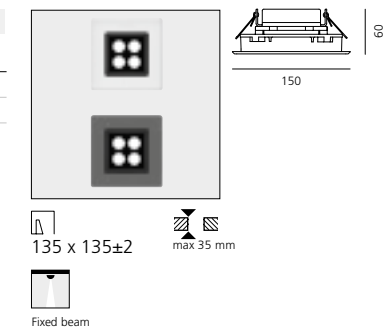

## ↳ EGO 220 DOWNLIGHT ROUND

Aluminium IK09 Stainless steel IK10

Fixed beam Adjustable beam +/- 15°

XS WF EL

MacAdam 4SDCM  
Life L70 (7K) >42300h  
CRI = 80

IP65/ IP67

### EGO 220 DOWNLIGHT ROUND

						Aluminium IK10		Stainless steel IK10	
W	CRI	Weight	Beam	Flux	CCT	Code	Code	Code	Code
17 W	=80	2,6 kg	5°	787 lm	3000K	<b>T4087NSPW00</b>	<b>T4086NSPW00</b>		
			38°	794 lm	3000K	<b>T4087WFLW00</b>	<b>T4086WFLW00</b>		
			EL	797 lm	3000K	<b>T4087ELPTW00</b>	<b>T4086ELPTW00</b>		

220/240Vac 50/60Hz electronic ballast included

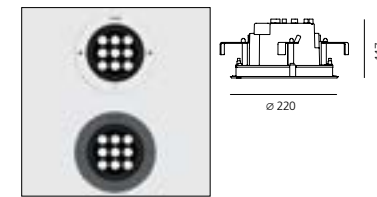

∅ 203±2  
max 40 mm

## ↳ EGO 220 DOWNLIGHT SQUARE

Aluminium IK09 Stainless steel IK10

Fixed beam Adjustable beam +/- 15°

XS WF EL

MacAdam 4SDCM  
Life L70 (7K) >42300h  
CRI = 80

IP65/ IP67

### EGO 220 DOWNLIGHT SQUARE

						Aluminium IK10		Stainless steel IK10	
W	CRI	Weight	Beam	Flux	CCT	Code	Code	Code	Code
17 W	=80	2,7 kg	5°	787 lm	3000K	<b>T4067NSPW00</b>	<b>T4066NSPW00</b>		
			38°	794 lm	3000K	<b>T4067WFLW00</b>	<b>T4066WFLW00</b>		
			EL	797 lm	3000K	<b>T4067ELPTW00</b>	<b>T4066ELPTW00</b>		

220/240Vac 50/60Hz electronic ballast included

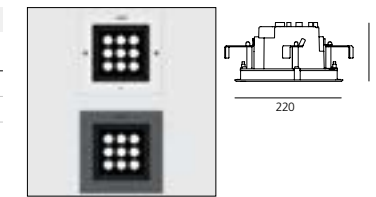

203 x 203±2  
max 40 mm

## EGO 220 FLAT DOWNLIGHT ROUND

						Aluminium IK10		Stainless steel IK10	
W	CRI	Weight	Beam	Flux	CCT	Code	Code	Code	Code
14 W	=80	1,78 kg	5°	787 lm	3000K	T42007NSPW00	T42015NSPW00		
			38°	794 lm	3000K	T42007WFLW00	T42015WFLW00		
			EL	797 lm	3000K	T42007ELPTW00	T42015ELPTW00		

Electronic ballast 500mA SELV supplied separately

Driver	V(ac)	L x W x H(mm)	IP	N.max	DIM	
cc 28W 500mA	220-240	120 x 38 x 25	67	1	-	<b>DV1039</b>
cc 31W 500mA	220-240	185 x 35 x 33	67	1	DALI	<b>DV1042</b>

Verify driver / recessed hole's dimensions.

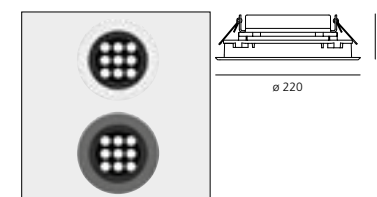

∅ 203±2  
max 35 mm



## EGO 220 FLAT DOWNLIGHT SQUARE

						Aluminium IK10		Stainless steel IK10	
W	CRI	Weight	Beam	Flux	CCT	Code	Code	Code	Code
14 W	=80	1,78 kg	5°	787 lm	3000K	<b>T42008NSPW00</b>	<b>T42016NSPW00</b>		
			38°	794 lm	3000K	<b>T42008WFLW00</b>	<b>T42016WFLW00</b>		
			EL	797 lm	3000K	<b>T42008ELPTW00</b>	<b>T42016ELPTW00</b>		

Electronic ballast 500mA SELV supplied separately

Driver	V(ac)	L x W x H(mm)	IP	N.max	DIM	
cc 28W 500mA	220-240	120 x 38 x 25	67	1	-	<b>DV1039</b>
cc 31W 500mA	220-240	185 x 35 x 33	67	1	DALI	<b>DV1042</b>

Verify driver / recessed hole's dimensions.

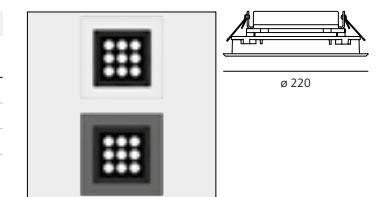

203 x 203±2  
max 35 mm





# Ego downlight

## ↳ glass



### ↳ EGO 150 GLASS DOWNLIGHT

Black Glass

XS WF EL

MacAdam 4SDCM  
Life L70 (7K) >42300h  
CRI = 80

IP65/ IP67  
IK09

Fixed beam Adjustable beam +/- 15°

#### EGO 150 GLASS DOWNLIGHT

W	CRI	Weight	Beam	Flux	CCT	Round Code	Square Code
8 W	=80	1,3 kg	5°	366 lm	3000K	<b>T4130NSPW00</b>	<b>T4120NSPW00</b>
			38°	321 lm	3000K	<b>T4130WFLW00</b>	<b>T4120WFLW00</b>
			EL	366 lm	3000K	<b>T4130ELPTW00</b>	<b>T4120ELPTW00</b>

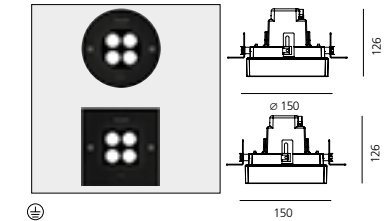

220/240Vac 50/60Hz electronic ballast included

Plate for plasterboard	<b>T409919</b>	<b>T409920</b>
------------------------	----------------	----------------

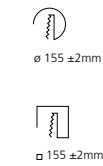

#### EGO 150 FLAT GLASS DOWNLIGHT

W	CRI	Weight	Beam	Flux	CCT	Round Code	Square Code
6 W	=80	0,92 kg	5°	366 lm	3000K	<b>T42017NSPW00</b>	<b>T42018NSPW00</b>
			38°	321 lm	3000K	<b>T42017WFLW00</b>	<b>T42018WFLW00</b>
			EL	366 lm	3000K	<b>T42017ELPTW00</b>	<b>T42018ELPTW00</b>

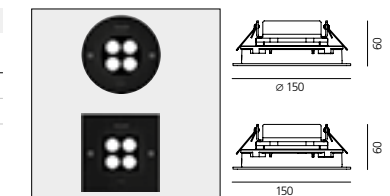

Electronic ballast 500mA supplied separately

Driver	V(ac)	L x W x H(mm)	IP	N.max	DIM	Code
cc 14W 500mA	220-240	79 x 38 x 25	67	2	-	<b>DV3002</b>
cc 28W 500mA	220-240	120 x 38 x 25	67	2-3	-	<b>DV1039</b>
cc 31W 500mA	220-240	185 x 35 x 33	67	3	DALI	<b>DV1042</b>

Verify driver / recessed hole's dimensions.

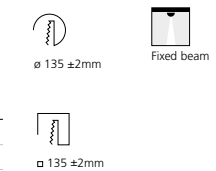

**Extra Spot optic 6°**  
Concentrated luminous flow to highlight details avoiding unwanted light dispersion.



**Wide Flood optic 40°**  
Wide luminous flow suitable for lighting large areas.



**Elliptical optic EL**  
Elliptical distribution of the luminous flow suitable for wall washer effect.

## ↳ EGO 220 GLASS DOWNLIGHT

Aluminium IK09	Stainless steel IK10	XS	WF	EL	MacAdam 4SDCM	IP65/ IP67
						
		Fixed beam	Adjustable beam ±15°		Life L70 (7K) >42300h CRI = 80	IK09

### EGO 220 GLASS DOWNLIGHT

						Round	Square
W	CRI	Weight	Beam	Flux	CCT	Code	Code
17 W	=80	2,4 kg	5°	787 lm	3000K	<b>T4131NSPW00</b>	<b>T4121NSPW00</b>
			38°	794 lm	3000K	<b>T4131WFLW00</b>	<b>T4121WFLW00</b>
			EL	797 lm	3000K	<b>T4131ELPTW00</b>	<b>T4121ELPTW00</b>

220/240Vac 50/60Hz electronic ballast included

Plate for plasterboard

**T409917**

**T409918**

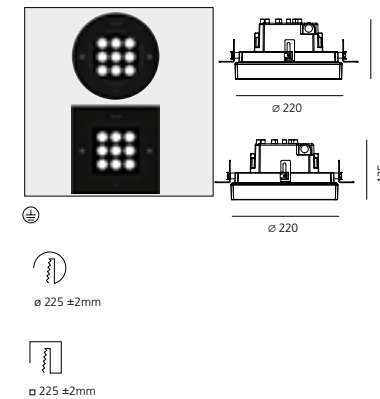

### EGO 220 FLAT GLASS DOWNLIGHT

						Round	Square
W	CRI	Weight	Beam	Flux	CCT	Code	Code
14 W	=80	1,67 kg	4°	787 lm	3000K	<b>T42019NSPW00</b>	<b>T42020NSPW00</b>
			38°	794 lm	3000K	<b>T42019WFLW00</b>	<b>T42020WFLW00</b>
			EL	797 lm	3000K	<b>T42019ELPTW00</b>	<b>T42020ELPTW00</b>

Electronic ballast 500mA SELV supplied separately

Driver	V(ac)	L x W x H(mm)	IP	N.max	DIM	
cc 28W 500mA	220-240	120 x 38 x 25	67	1	-	<b>DV1039</b>
cc 31W 500mA	220-240	185 x 35 x 33	67	1	DALI	<b>DV1042</b>

Verify driver / recessed hole's dimensions.

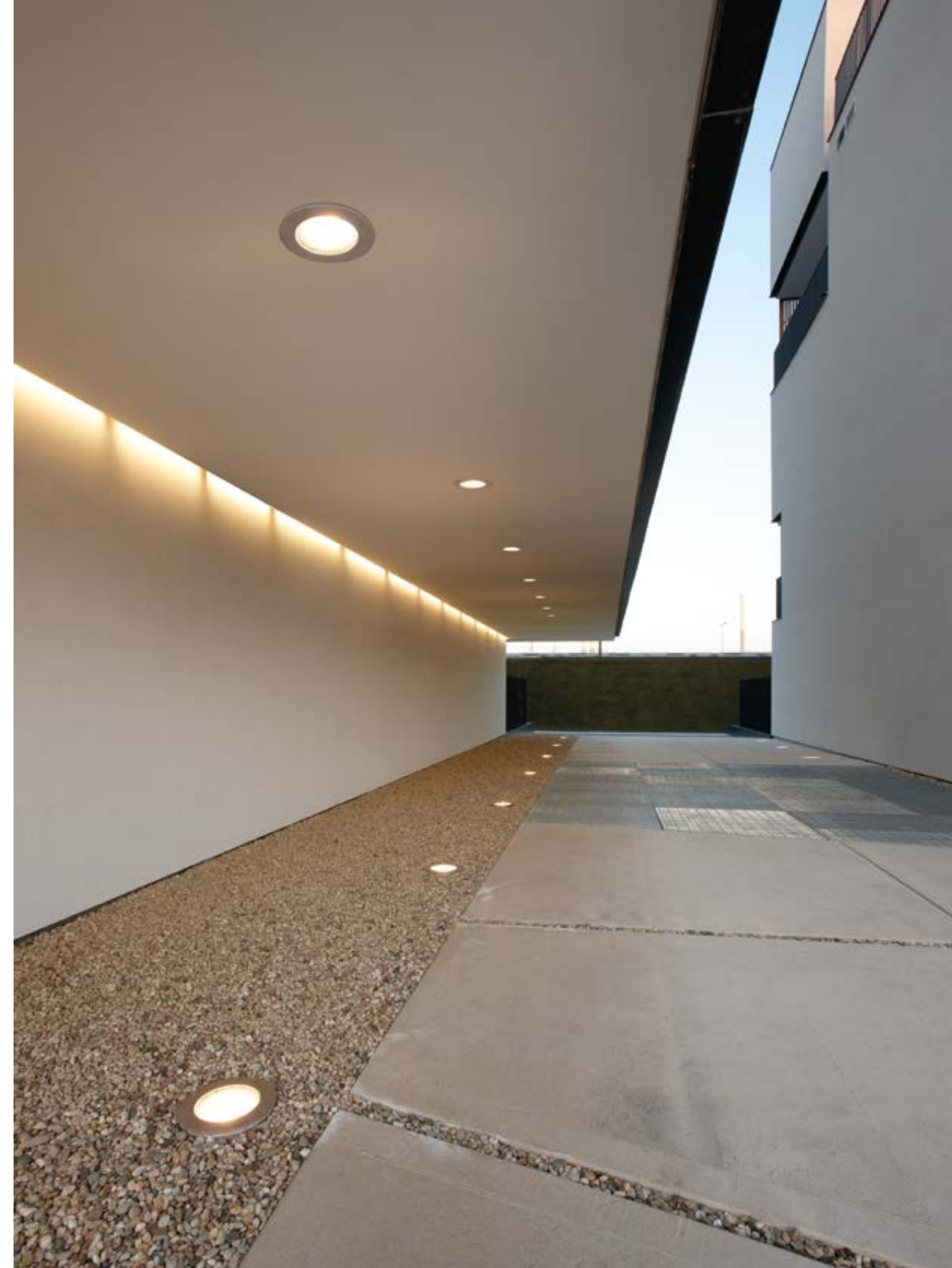
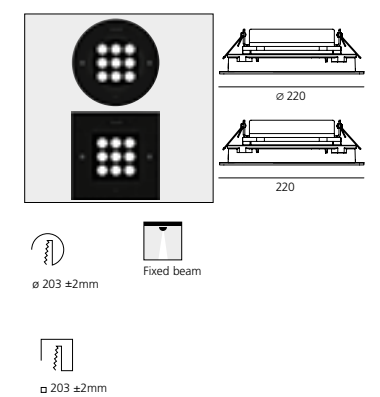

# Ego walk over Ego drive over

↳ 2012





Ego  
↪ Walk over  
Drive over

# Ego walk/drive over typologies

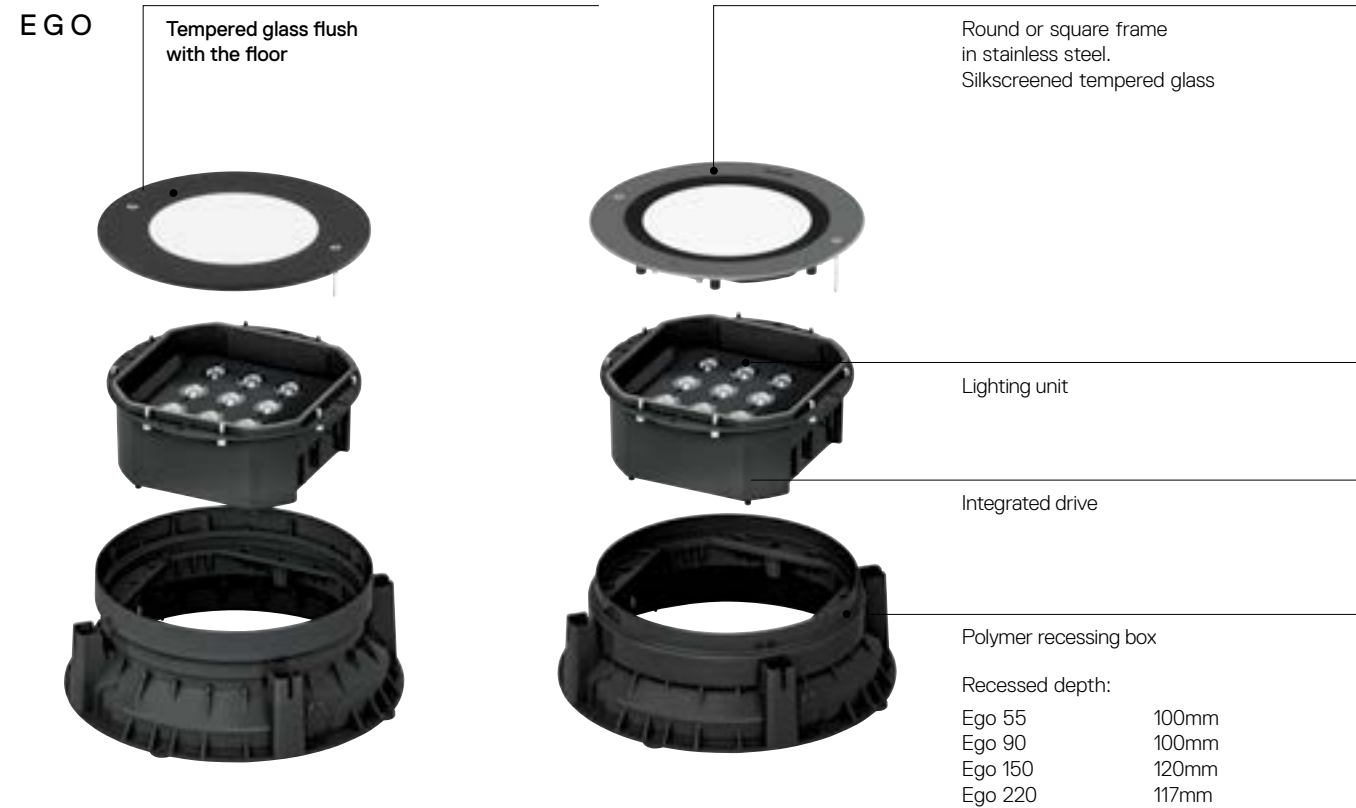

Light fixture with high-performance LED light sources. Recessed ground installation. Walk-over and drive-over versions.

Depth of recess box:  
Ego WO/DO: 110-120 mm  
Ego Flat WO: 60 mm

WO/DO round and square version, each one in 5 different sizes.

Fixture consisting of body, frame, glass diffuser, housing. Aluminium body EN AB-44100 with silicone gaskets. All versions are available with stainless steel frames. Ego 55-90 / Ego flat 55-90 also available with polished aluminium frame. Ego 150-220 / Ego flat 150-220 also available with 8mm-thick glass flush with the floor.

Housing in composite techno polymer, to be ordered separately.

Ego Flat WO H05RN-F feeding cable length: 300 cm.  
Ego WO/DO feeding cable:  
H05RNF 2x1 for Ego 55 - 90,  
H05RNF 3x1 for Ego 150,  
H07RNF 3x1 for Ego 220 - 320, cable length 30 cm.

All Ego versions (excluding Flat version) are supplied with electronic power supply inside the luminaire body. For 55 and 90 versions 24 V power supply and remote power supply to be ordered separately.

All Ego Flat can be operated by a remote power supply to be ordered separately. Connection cable includes a IP68 electrical terminal board.

Housing locked by anti-vandal TORX screws in AISI 316 stainless steel.

Glass surface temperature below 40°C.

Fixed and adjustable lenses in PMMA in 3 versions with different beam angles.

Die-cast painted aluminium with 3-stage outdoor treatment: nanotechnologies, antioxidant primer, polyester paint.

Technical features of light fixtures in compliance with EN60598-1 and part 2-13.

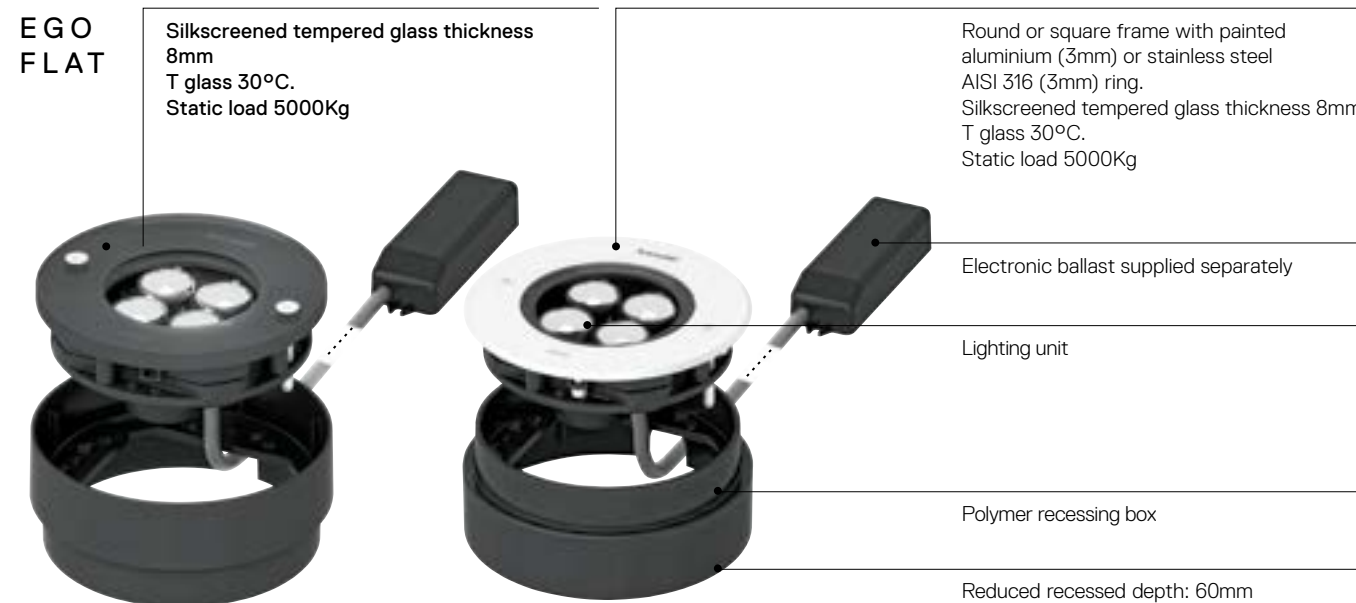

For further information on Ego walk over/drive over  
↪ visit [artemide.com](http://artemide.com)

## ↳ EGO 55 ALUMINIUM

Aluminium

XS WF EL

Electronic ballast  
24V SELV supplied  
separately

MacAdam 4SDCM  
Life L90 (10K) >54400h  
CRI = 80

IP65/ IP67  
IK09







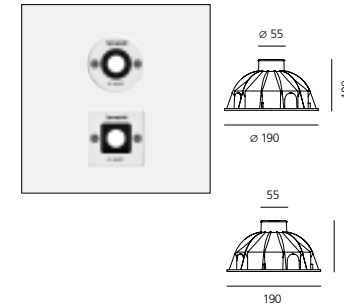

### EGO 55 WALK OVER

						Round	Square
W	CRI	Weight	Beam	Flux	CCT	Code	Code
1,5 W	=80	0,28 kg	14°	83 lm	3000K	<b>T4031SPW00</b>	<b>T4001SPW00</b>
			32°	76 lm	3000K	<b>T4031WFLW00</b>	<b>T4001WFLW00</b>
			EL	77 lm	3000K	<b>T4031ELPTW00</b>	<b>T4001ELPTW00</b>



Recessing box				T409908
Drive	24 W IP67	DALI	185x35x33mm	<b>DV1041</b>
Drive	24 W IP67		148x40x32mm	<b>T409996</b>
Drive	60 W IP67		163x43x32mm	<b>T409998</b>
Drive	90 W IP67		161x61x36mm	<b>T409999</b>

Please see page 945 for drives installation details.

### EGO 55 FLAT WALK OVER

						Round	Square
W	CRI	Weight	Beam	Flux	CCT	Code	Code
1 W	=80	0,39 kg	14°	83 lm	3000K	<b>T40000SPW00</b>	<b>T40001SPW00</b>
			32°	76 lm	3000K	<b>T40000WFLW00</b>	<b>T40001WFLW00</b>
			EL	77 lm	3000K	<b>T40000ELPTW00</b>	<b>T40001ELPTW00</b>

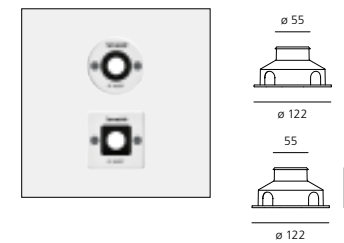

Electronic ballast 350mA supplied separately

Recessing box							NL40021H0
Driver	V(ac)	L x W x H(mm)	IP	N.max	DIM	Code	
cc 14W 350mA	220-240	79 x 38 x 25	67	2-10	-	<b>DV3001</b>	
cc 23W 350mA	220-240	185 x 35 x 33	67	3-12	DALI	<b>DV1042</b>	

Verify drive / recessed hole's dimensions.

## ↳ EGO 55 STAINLESS STEEL

Stainless steel

XS WF EL

Electronic ballast  
24V SELV supplied  
separately

MacAdam 4SDCM  
Life L90 (10K) >54400h  
CRI = 80

IP65/ IP67  
IK09







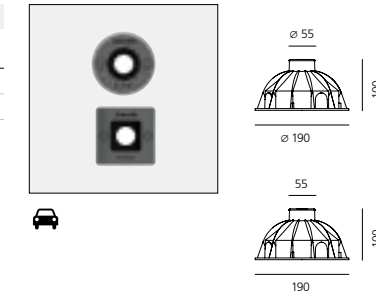

### EGO 55 DRIVE OVER

						Round	Square
W	CRI	Weight	Beam	Flux	CCT	Code	Code
1,5 W	=80	0,28 kg	14°	83 lm	3000K	<b>T4032SPW00</b>	<b>T4002SPW00</b>
			32°	76 lm	3000K	<b>T4032WFLW00</b>	<b>T4002WFLW00</b>
			EL	77 lm	3000K	<b>T4032ELPTW00</b>	<b>T4002ELPTW00</b>



Recessing box				T409908
Drive	24 W IP67	DALI	185x35x33mm	<b>DV1041</b>
Drive	24 W IP67		148x40x32mm	<b>T409996</b>
Drive	60 W IP67		163x43x32mm	<b>T409998</b>
Drive	90 W IP67		161x61x36mm	<b>T409999</b>

Please see page 945 for drives installation details.

### EGO 55 FLAT WALK OVER

						Round	Square
W	CRI	Weight	Beam	Flux	CCT	Code	Code
1 W	=80	0,39 kg	14°	83 lm	3000K	<b>T40002SPW00</b>	<b>T40003SPW00</b>
			32°	76 lm	3000K	<b>T40002WFLW00</b>	<b>T40003WFLW00</b>
			EL	77 lm	3000K	<b>T40002ELPTW00</b>	<b>T40003ELPTW00</b>

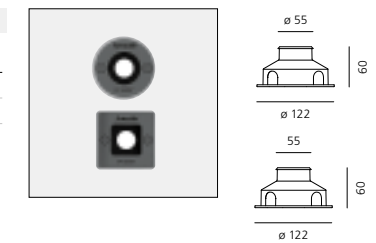

Electronic ballast 350mA supplied separately

Recessing box							NL40021H0
Driver	V(ac)	L x W x H(mm)	IP	N.max	DIM	Code	
cc 14W 350mA	220-240	79 x 38 x 25	67	2-10	-	<b>DV3001</b>	
cc 23W 350mA	220-240	185 x 35 x 33	67	3-12	DALI	<b>DV1042</b>	

Verify drive / recessed hole's dimensions.

## ↳ EGO 90 ALUMINIUM

Aluminium

Fixed beam Adjustable beam +/- 8° XS WF EL

Electronic ballast 24V SELV supplied separately

MacAdam 4SDCM Life L90 (10K) >54400h CRI = 80

IP65/ IP67 IK09





### EGO 90 WALK OVER

						Round	Square
W	CRI	Weight	Beam	Flux	CCT	Code	Code
3 W	=80	0,50 kg	10°	220 lm	3000K	<b>T4034SPW00</b>	<b>T4004SPW00</b>
			24°	179 lm	3000K	<b>T4034FLW00</b>	<b>T4004FLW00</b>
			EL	162 lm	3000K	<b>T4034ELPTW00</b>	<b>T4004ELPTW00</b>

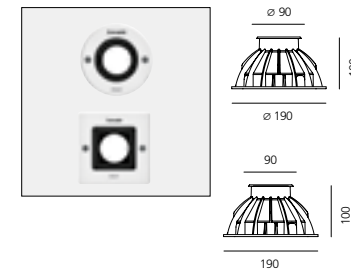

Recessing box				T409907
Drive	24 W IP67	DALI	185x35x33mm	<b>DV1041</b>
Drive	24 W IP67		148x40x32mm	<b>T409996</b>
Drive	60 W IP67		163x43x32mm	<b>T409998</b>
Drive	90 W IP67		161x61x36mm	<b>T409999</b>

Please see page 945 for drives installation details.

### EGO 90 FLAT WALK OVER

						Round	Square
W	CRI	Weight	Beam	Flux	CCT	Code	Code
3 W	=80	0,50 kg	10°	220 lm	3000K	<b>T40004SPW00</b>	<b>T40005SPW00</b>
			24°	179 lm	3000K	<b>T40004FLW00</b>	<b>T40005FLW00</b>
			EL	162 lm	3000K	<b>T40004ELPTW00</b>	<b>T40005ELPTW00</b>

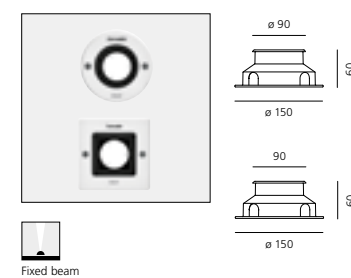

Recessing box				NL40022H0
---------------	--	--	--	-----------

Driver	V(ac)	L x W x H(mm)	IP	N.max	DIM	Code
cc 14W 350mA	220-240	79 x 38 x 25	67	2-10	-	<b>DV3001</b>
cc 23W 350mA	220-240	185 x 35 x 33	67	3-12	DALI	<b>DV1042</b>

Verify drive / recessed hole's dimensions.

## ↳ EGO 90 STAINLESS STEEL

Stainless steel

Fixed beam Adjustable beam +/- 8° XS WF EL

Electronic ballast 24V SELV supplied separately

MacAdam 4SDCM Life L90 (10K) >54400h CRI = 80

IP65/ IP67 IK09





### EGO 90 DRIVE OVER

						Round	Square
W	CRI	Weight	Beam	Flux	CCT	Code	Code
3 W	=80	0,50 kg	10°	220 lm	3000K	<b>T4033SPW00</b>	<b>T4003SPW00</b>
			24°	179 lm	3000K	<b>T4033FLW00</b>	<b>T4003FLW00</b>
			EL	162 lm	3000K	<b>T4033ELPTW00</b>	<b>T4003ELPTW00</b>

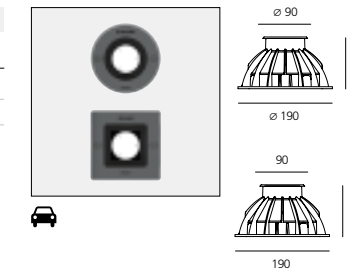

Recessing box				T409907
Drive	24 W IP67	DALI	185x35x33mm	<b>DV1041</b>
Drive	24 W IP67		148x40x32mm	<b>T409996</b>
Drive	60 W IP67		163x43x32mm	<b>T409998</b>
Drive	90 W IP67		161x61x36mm	<b>T409999</b>

Please see page 945 for drives installation details.

### EGO 90 FLAT WALK OVER

						Round	Square
W	CRI	Weight	Beam	Flux	CCT	Code	Code
3 W	=80	0,50 kg	10°	220 lm	3000K	<b>T40006SPW00</b>	<b>T40007SPW00</b>
			24°	179 lm	3000K	<b>T40006FLW00</b>	<b>T40007FLW00</b>
			EL	162 lm	3000K	<b>T40006ELPTW00</b>	<b>T40007ELPTW00</b>

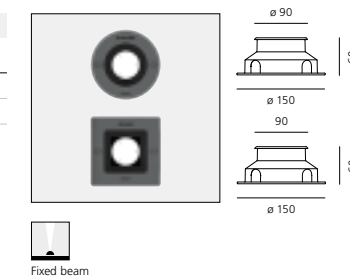

Recessing box				NL40022H0
---------------	--	--	--	-----------

Driver	V(ac)	L x W x H(mm)	IP	N.max	DIM	Code
cc 14W 350mA	220-240	79 x 38 x 25	67	2-10	-	<b>DV3001</b>
cc 23W 350mA	220-240	185 x 35 x 33	67	3-12	DALI	<b>DV1042</b>

Verify drive / recessed hole's dimensions.



## ↳ EGO 150 STAINLESS STEEL

Stainless steel

Fixed beam Adjustable beam +/- 15° XS WF EL

MacAdam 4SDCM Life L70 (7K) >42300h CRI = 80

IP65/ IP67 IK09

### EGO 150 DRIVE OVER

						Round	Square
W	CRI	Weight	Beam	Flux	CCT	Code	Code
8 W	=80	1,35 kg	5°	366 lm	3000K	<b>T4036NSPW00</b>	<b>T4006NSPW00</b>
			38°	321 lm	3000K	<b>T4036WFLW00</b>	<b>T4006WFLW00</b>
			EL	366 lm	3000K	<b>T4036ELPTW00</b>	<b>T4006ELPTW00</b>

220/240Vac 50/60Hz electronic ballast included

Recessing box	<b>T409905</b>	<b>T409906</b>
---------------	----------------	----------------

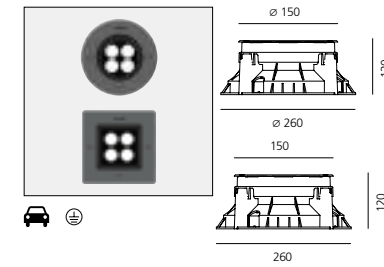

## ↳ EGO 220 STAINLESS STEEL

Stainless steel

Fixed beam Adjustable beam +/- 15° XS WF EL

MacAdam 4SDCM Life L70 (7K) >42300h CRI = 80

IP65/ IP67 IK09

### EGO 220 DRIVE OVER

						Round	Square
W	CRI	Weight	Beam	Flux	CCT	Code	Code
16 W	=80	3,20 kg	5°	787 lm	3000K	<b>T4039NSPW00</b>	<b>T4009NSPW00</b>
			38°	794 lm	3000K	<b>T4039WFLW00</b>	<b>T4009WFLW00</b>
			EL	797 lm	3000K	<b>T4039ELPTW00</b>	<b>T4009ELPTW00</b>

220/240Vac 50/60Hz electronic ballast included

Recessing box	<b>T409903</b>	<b>T409904</b>
---------------	----------------	----------------

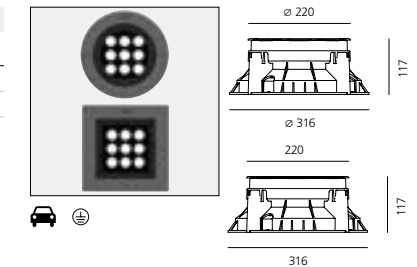

### EGO 150 FLAT WALK OVER

						Round	Square
W	CRI	Weight	Beam	Flux	CCT	Code	Code
6 W	=80	0,88 kg	5°	366 lm	3000K	<b>T40010NSPW00</b>	<b>T40011NSPW00</b>
			38°	321 lm	3000K	<b>T40010WFLW00</b>	<b>T40011WFLW00</b>
			EL	366 lm	3000K	<b>T40010ELPTW00</b>	<b>T40011ELPTW00</b>

Electronic ballast 500mA SELV supplied separately

Recessing box	<b>NL40025H0</b>	<b>NL40023H0</b>
---------------	------------------	------------------

Driver	V(ac)	L x W x H(mm)	IP	N.max	DIM	Code
cc 14W 500mA	220-240	79 x 38 x 25	67	2	-	<b>DV3002</b>
cc 28W 500mA	220-240	120 x 38 x 25	67	2-3	-	<b>DV1039</b>
cc 31W 500mA	220-240	185 x 35 x 33	67	3	DALI	<b>DV1042</b>

Verify drive / recessed hole's dimensions.

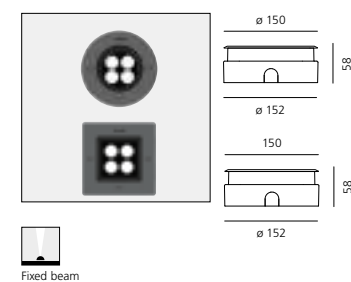

### EGO 220 FLAT WALK OVER

						Round	Square
W	CRI	Weight	Beam	Flux	CCT	Code	Code
14 W	=80	1,78 kg	5°	787 lm	3000K	<b>T40014NSPW00</b>	<b>T40015NSPW00</b>
			38°	794 lm	3000K	<b>T40014WFLW00</b>	<b>T40015WFLW00</b>
			EL	797 lm	3000K	<b>T40014ELPTW00</b>	<b>T40015ELPTW00</b>

Electronic ballast 500mA SELV supplied separately

Recessing box	<b>NL40026H0</b>	<b>NL40023H0</b>
---------------	------------------	------------------

Driver	V(ac)	L x W x H(mm)	IP	N.max	DIM	Code
cc 28W 500mA	220-240	120 x 38 x 25	67	1	-	<b>DV1039</b>
cc 31W 500mA	220-240	185 x 35 x 33	67	1	DALI	<b>DV1042</b>

Verify drive / recessed hole's dimensions.

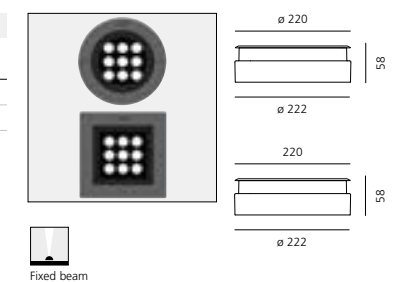

# Ego walk over ↪ Glass



## ↳ EGO 150 GLASS WALK OVER

Black Glass

Fixed beam Adjustable beam +/- 15°

XS WF EL

MacAdam 4SDCM  
Life L70 (7K) >42300h  
CRI = 80

IP65/ IP67  
IK09



### EGO 150 WALK OVER

						Round	Square
W	CRI	Weight	Beam	Flux	CCT	Code	Code
8 W	=80	1,35 kg	5°	366 lm	3000K	<b>T4110NSPW00</b>	<b>T4100NSPW00</b>
			38°	321 lm	3000K	<b>T4110WFLW00</b>	<b>T4100WFLW00</b>
			EL	366 lm	3000K	<b>T4110ELPTW00</b>	<b>T4100ELPTW00</b>
220/240Vac 50/60Hz electronic ballast included							
Recessing box						<b>T409913</b>	<b>T409914</b>

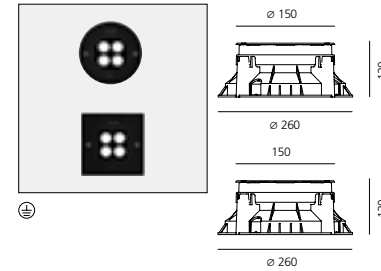

## ↳ EGO 220 GLASS WALK OVER

Black Glass

Fixed beam Adjustable beam +/- 15°

XS WF EL

MacAdam 4SDCM  
Life L70 (7K) >42300h  
CRI = 80

IP65/ IP67  
IK09



### EGO 220 WALK OVER

						Round	Square
W	CRI	Weight	Beam	Flux	CCT	Code	Code
17 W	=80	3,20 kg	5°	787 lm	3000K	<b>T4111NSPW00</b>	<b>T4101NSPW00</b>
			38°	794 lm	3000K	<b>T4111WFLW00</b>	<b>T4101WFLW00</b>
			EL	797 lm	3000K	<b>T4111ELPTW00</b>	<b>T4101ELPTW00</b>
220/240Vac 50/60Hz electronic ballast included							
Recessing box						<b>T409911</b>	<b>T409912</b>

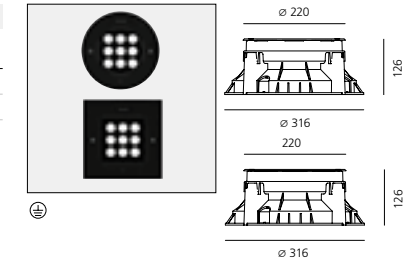

### EGO 150 FLAT WALK OVER

						Round	Square
W	CRI	Weight	Beam	Flux	CCT	Code	Code
6 W	=80	0,92 kg	5°	366 lm	3000K	<b>T40017NSPW00</b>	<b>T40018NSPW00</b>
			38°	321 lm	3000K	<b>T40017WFLW00</b>	<b>T40018WFLW00</b>
			EL	366 lm	3000K	<b>T40017ELPTW00</b>	<b>T40018ELPTW00</b>
Electronic ballast 500mA supplied separately							
Recessing box						<b>NL40029H0</b>	<b>NL40027H0</b>

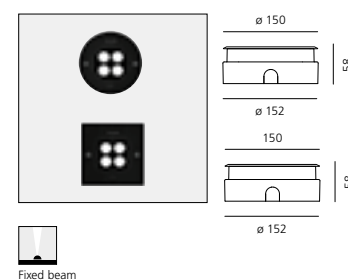

### EGO 220 FLAT WALK OVER

						Round	Square
W	CRI	Weight	Beam	Flux	CCT	Code	Code
14 W	=80	1,67 kg	5°	787 lm	3000K	<b>T40019NSPW00</b>	<b>T40020NSPW00</b>
			38°	794 lm	3000K	<b>T40019WFLW00</b>	<b>T40020WFLW00</b>
			EL	797 lm	3000K	<b>T40019ELPTW00</b>	<b>T40020ELPTW00</b>
Electronic ballast 500mA supplied separately							
Recessing box						<b>NL40030H0</b>	<b>NL40028H0</b>

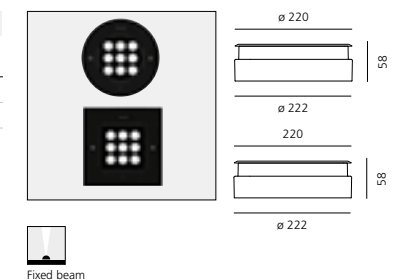

Driver	V(ac)	L x W x H(mm)	IP	N.max	DIM	Code
cc 14W 500mA	220-240	79 x 38 x 25	67	2	-	<b>DV3002</b>
cc 28W 500mA	220-240	120 x 38 x 25	67	2-3	-	<b>DV1039</b>
cc 31W 500mA	220-240	185 x 35 x 33	67	3	DALI	<b>DV1042</b>

Verify drive / recessed hole's dimensions.

Driver	V(ac)	L x W x H(mm)	IP	N.max	DIM	Code
cc 28W 500mA	220-240	120 x 38 x 25	67	1	-	<b>DV1039</b>
cc 31W 500mA	220-240	185 x 35 x 33	67	1	DALI	<b>DV1042</b>

Verify drive / recessed hole's dimensions.

# Megara

Michele De Lucchi

↪ 2011

Light fixture with high-performance LED light sources.

Drive-over recessed floor installation with floor-protruding cap. All the versions are drive-over up to 5000Kg. Due to the low height of the cap, Megara 90 is also suitable for installation in walk-over areas, being careful to avoid areas of direct transit (near walls, buildings, etc.). Cap's temperature 35° C.

3 sizes (90, 150, 220 mm).

Composed by body, cap, diffuser, recessing box.

Body and cap in painted EN AB44100 aluminium, silicone gaskets; provided with 30 cm-long pre-resined three-pole connection cable (H07RN-F for versions 90 and 150, H05RN-F for version 220).

Electronic ballast integrated in the body.

Diffuser in UV resistant polycarbonate.

Power connection to the mains by means of the IP68 connector supplied with the light fixture, which can be housed in the recessing box and is suitable for cables with a diameter from 5 to 13.3 mm.

Fixing to the recessing box is ensured by means of anti-vandal screws TORX.

Recessing box for laying in reinforced polymer to be ordered separately.

Radial emission beam optic.

1, 2, 4 beam and full configurations.

Screws in AISI 316 stainless steel.

Painted die-cast aluminium with 3-stage outdoor treatment: nanotechnologies, antioxidant primer, polyester paint.

Technical features of light fixtures in compliance with EN60598-1 and part 2-13.



For further information on Megara  
↪ visit [artemide.com](http://artemide.com)

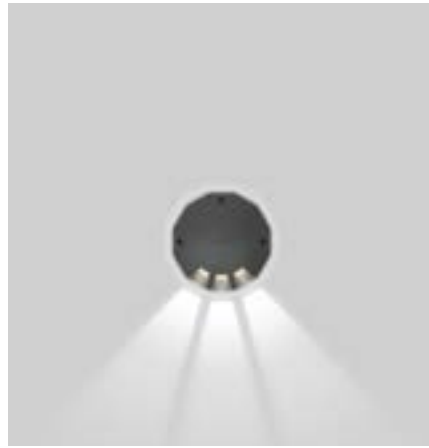

MEGARA 90 - 1 BEAM



MEGARA 150 - 1 BEAM



MEGARA 220 - 1 BEAM



MEGARA 90 - 2 BEAMS

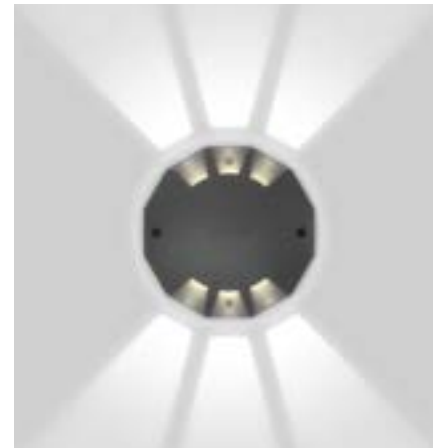

MEGARA 150 - 2 BEAMS



MEGARA 220 - 2 BEAMS



MEGARA 90 - 4 BEAMS



MEGARA 150 - 4 BEAMS



MEGARA 220 - 4 BEAMS



MEGARA 90 - FULL



MEGARA 150 - FULL



MEGARA 220 - FULL

PAINTED ALUMINIUM CAP

DIFFUSER IN UV RESISTANT POLYCARBONATE

RECESSING BOX IN POLYMER

Recessed depth:

Megara 90	101mm
Megara 150	122mm
Megara 220	118mm

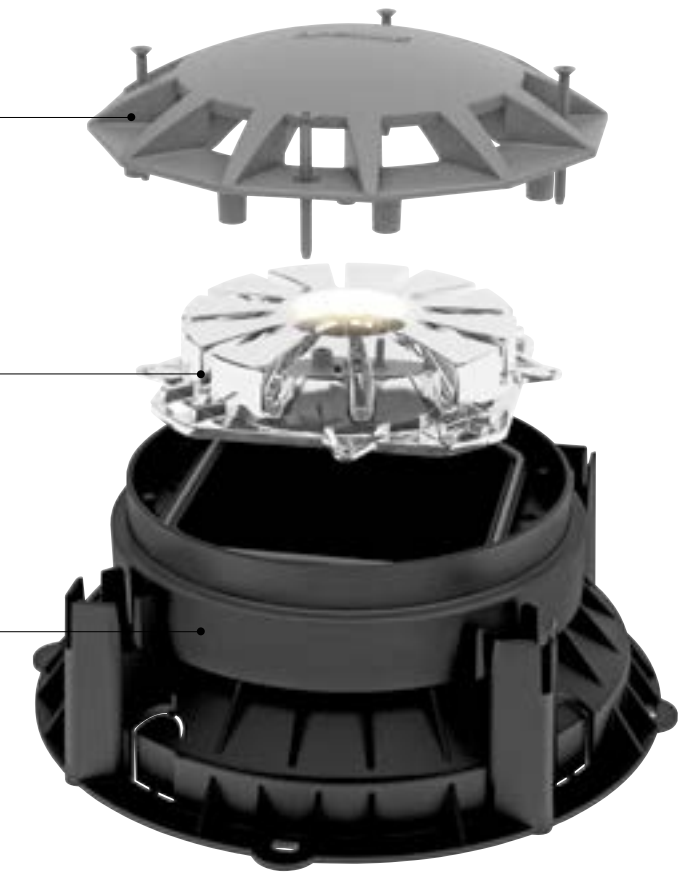

## MEGARA 90

Dark grey



EL



220/240Vac 50/60Hz  
electronic ballast included

MacAdam 4SDCM  
L70(6K)>39300 h  
CRI =80

IP65/ IP67



### 1 Beam

W	Weight	Beam	Flux	CCT
2,5 W	0,4 kg	AS	7 lm	3000K

Code  
**T415300W00**

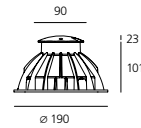
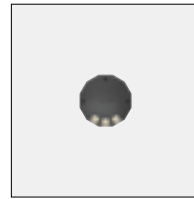

### 2 Beams

W	Weight	Beam	Flux	CCT
2,5 W	0,4 kg	AS	12 lm	3000K

Code  
**T415200W00**

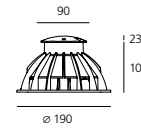
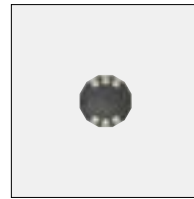

### 3 Beams

W	Weight	Beam	Flux	CCT
2,5 W	0,4 kg	AS	15 lm	3000K

Code  
**T415100W00**

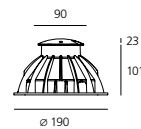
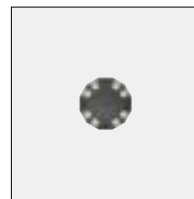

### 4 Beams

W	Weight	Beam	Flux	CCT
2,5 W	0,4 kg	AS	22 lm	3000K

Code  
**T415000W00**

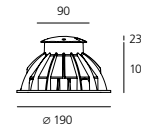
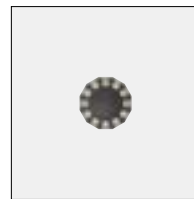

### Accessories

Recessing box

Code  
**T409907**

## MEGARA 150

Dark grey



EL



220/240Vac 50/60Hz  
electronic ballast included

MacAdam 4SDCM  
L70(6K)>39300 h  
CRI =80

IP65/ IP67



### 1 Beam

W	Weight	Beam	Flux	CCT
4 W	1 kg	AS	8 lm	3000K

Code  
**T415700W00**

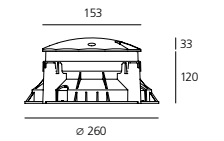

### 2 Beams

W	Weight	Beam	Flux	CCT
4 W	1 kg	AS	14 lm	3000K

Code  
**T415600W00**

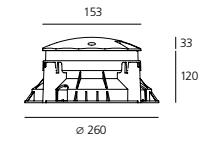

### 3 Beams

W	Weight	Beam	Flux	CCT
4 W	1 kg	AS	18 lm	3000K

Code  
**T415500W00**

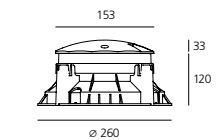
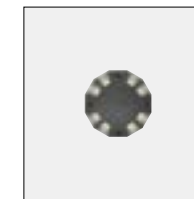

### 4 Beams

W	Weight	Beam	Flux	CCT
4 W	1 kg	AS	26 lm	3000K

Code  
**T415400W00**

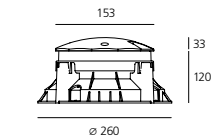
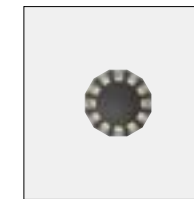





### Accessories

Recessing box

Code  
**T409905**

↪ MEGARA 220

Dark grey 	EL 	220/240Vac 50/60Hz electronic ballast included	MacAdam 4SDCM L70(6K)>39300 h CRI =80	IP65/ IP67  IK10 
--	---	---	---	--

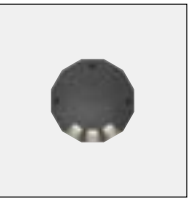
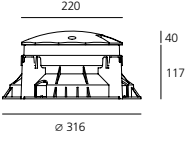

**1 Beam**

W	Weight	Beam	Flux	CCT
8,5 W	0,4 kg	AS	8 lm	3000K

		
<b>Code</b>	<b>T416100W00</b>	

**2 Beams**

W	Weight	Beam	Flux	CCT
8,5 W	0,4 kg	AS	13 lm	3000K

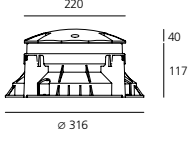
		
<b>Code</b>	<b>T416000W00</b>	

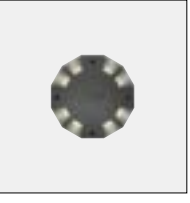
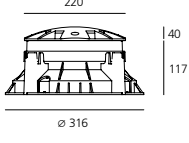

**3 Beams**

W	Weight	Beam	Flux	CCT
8,5 W	0,4 kg	AS	17 lm	3000K

		
<b>Code</b>	<b>T415900W00</b>	

**4 Beams**

W	Weight	Beam	Flux	CCT
8,5 W	0,4 kg	AS	26 lm	3000K

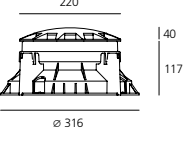
		
<b>Code</b>	<b>T415800W00</b>	

**Accessories**

Recessing box	<b>Code</b>	<b>T409903</b>
---------------	-------------	----------------



# Microled

↪ 2013

Light fixture with high-performances LED light sources.

Floor installation.

Consists of diffuser, body, ring, housing.

Diffuser in glass, 3mm-thick.

Body in technopolymer, with or without frame.

Ring in stainless steel AISI 316L.

Housing in plastic material (available separately).

Remote driver.

Electrical connection to the ballast by means of a two-pole H05RN-F cable and appropriate IP68 terminal board.



For further information on Microled  
↪ visit [artemide.com](http://artemide.com)



## ↪ MICROLED

Stainless steel



XF



Driver 12Vdc SELV supplied separately.  
Walkable 500 kg.

IP65 / IP67



IK10

CRI =75

### MICROLED

W	Weight	Beam	Flux	CCT
0,5 W	0,2 kg	XF	5,6 lm	3000K

Code  
**NL42036VSK0**

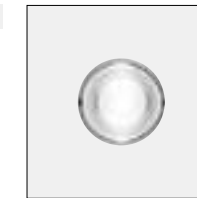

∅ 36

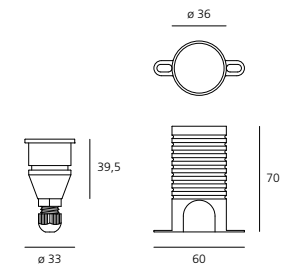

W	Weight	Beam	Flux	CCT
0,5 W	0,2 kg	XF	5,6 lm	3000K

Code  
**NL42037VSK0**

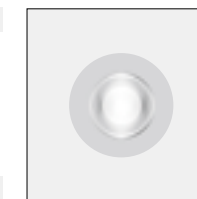

∅ 36

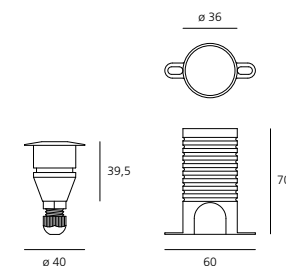

### Accessories

Recessing box

Code  
**NL42040H0**

Driver	Vac	IP	L <sub>mm</sub>	W <sub>mm</sub>	H <sub>mm</sub>
25W 12Vdc	24 Vdc	IP67	148	40	32 25 max
60W 12Vdc	24 Vdc	IP67	163	43	32 60 max

Code  
**T409996**  
**T409998**

### MICROLED RGB

W	Weight	Beam
1,5 W	0,2 kg	XF

Code  
**NL42038**



∅ 36

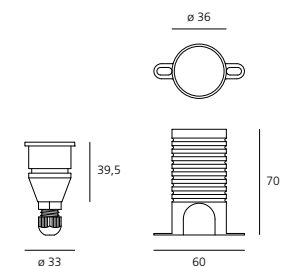

W	Weight	Beam
1,5 W	0,2 kg	XF

Code  
**NL42039**

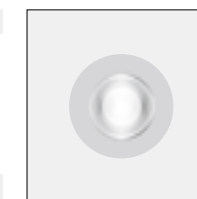

∅ 36

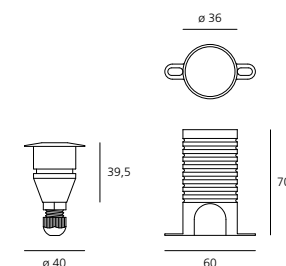

### Accessories

Recessing box

DSC 30 USB interface DMX stand alone

9V/350mA ballast with mini USB connector for DSC30

50cm cable with HE10 connector for keyboard (optional)

Code  
**NL42040H0**  
**NL19030**  
**NL19031**

**NL7833**

Driver	Vac	W	Vdc	Ch	Control	LxWxH	IP	1,5W	Code
Driver NLX1-100	120-250Vac	95W	24Vdc PWM	1xRGB	DMX/DALI	388x42x30	40	50 max	<b>NL12150</b>
Driver NLX1-75	24Vdc	144W	24Vdc PWM	1xRGB	DMX/DALI	153x50x23	40	80 max	<b>NL19084</b>
PSU 150W	90-305Vac	150W	24Vdc			228x68x39	67		<b>DV5004</b>
Driver NLX2-75	90-260Vac	75W	24Vdc PWM	2xRGB	DMX	270x200x80	40	40 max	<b>NL75190</b>
Driver NLX1-100 IP	120-250Vac	95W	24Vdc PWM	1xRGB	DMX/DALI	340x103x61	66	50 max	<b>DV1046</b>

\*PSU 24Vdc (i.e. Cod. DV5004) mandatory



# Aria

Massimo Sacconi

↪ 2012

Light fixture with high-performance LED light sources.  
Wall or ceiling installation.

Composed by: frame (aluminium), body (injection mould of aluminium), asymmetrical reflector, fixing springs or housing (bend metal - to be ordered separately).

Body and frame are painted with outdoor treatment three stages: nanotechnologies, antioxidant primer, polyester paint.

Metalized polycarbonate reflector.

Silicone gasket.

Protection screen in tempered glass, 3mm-thick.

Electrical connection to the ballast by means of a cable with appropriate terminal board supplied with the fixture.

Technical features of light fixtures in compliance with EN60598-1.



For further information on Aria  
↪ visit [artemide.com](http://artemide.com)

## ↪ ARIA

White 01 06	Black 04 04	Silver 12 02	EL 	Electronic ballast 700 mA supplied separately	MacAdam 4SDCM CRI = 85	IP40/ IP65 650°
-------------------	-------------------	--------------------	--------	--	---------------------------	--------------------

### ARIA MINI

W	Weight	Beam	CCT	Flux	IP
6 W	0,60 kg	AS	3000 K	215 lm 204 lm	65 40

Code
<b>AJ100.</b> 01/04/12
<b>AJ300.</b> 01/04/12

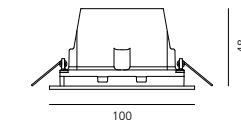

Life L70 (6K)>36000h

72 x 52 ±2

### Accessories

Recessing box

Code
<b>AJ90000</b>

### ARIA MICRO

W	Weight	Beam	CCT	Flux	IP
2,5 W	0,36 kg	AS	3000 K	57 lm 40	65 40

Code
<b>NL31019VTK0.06/04/02</b>
<b>NL31018VTK0.06/04/02</b>

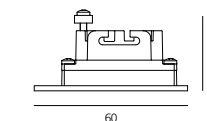

Life L70 (10K)>60500h

49 x 46 ±2

### Accessories

Recessing box

Code
<b>NL31020H0</b>

Driver	V(ac)	DIM	L <sub>mm</sub>	W <sub>mm</sub>	H <sub>mm</sub>	IP	Aria Mini			Code
							3W	6 W	2,5 W	
cc 14W 350mA	220-240	-	79	38	25	67	4			<b>DV3001</b>
cc 14W 700mA	220-240	-	79	38	25	67		2	2-8	<b>DV3003</b>
cc 30W 700mA	220-240	-	120	38	25	67		3-4	7-12	<b>DV3004</b>
cc 9W 350mA	220-240	-	75	38	22	67	2			<b>NL19032</b>
cc 10W 700mA	220-240	-	75	38	22	67		1	2-3	<b>NL19035</b>
cc 20W 700mA	220-240	-	125	38	22	67		2	2-7	<b>NL19036</b>
cc 30W 700mA	220-240	-	125	38	22	20		3-4	7-12	<b>DV1040</b>
cc 23W 350mA	220-240	DALI	185	35	33	67	4			<b>DV1042</b>
cc 38W 700mA	220-240	DALI	185	35	33	67		4	3-13	<b>DV1042</b>

Verify driver / recessed hole's dimensions.

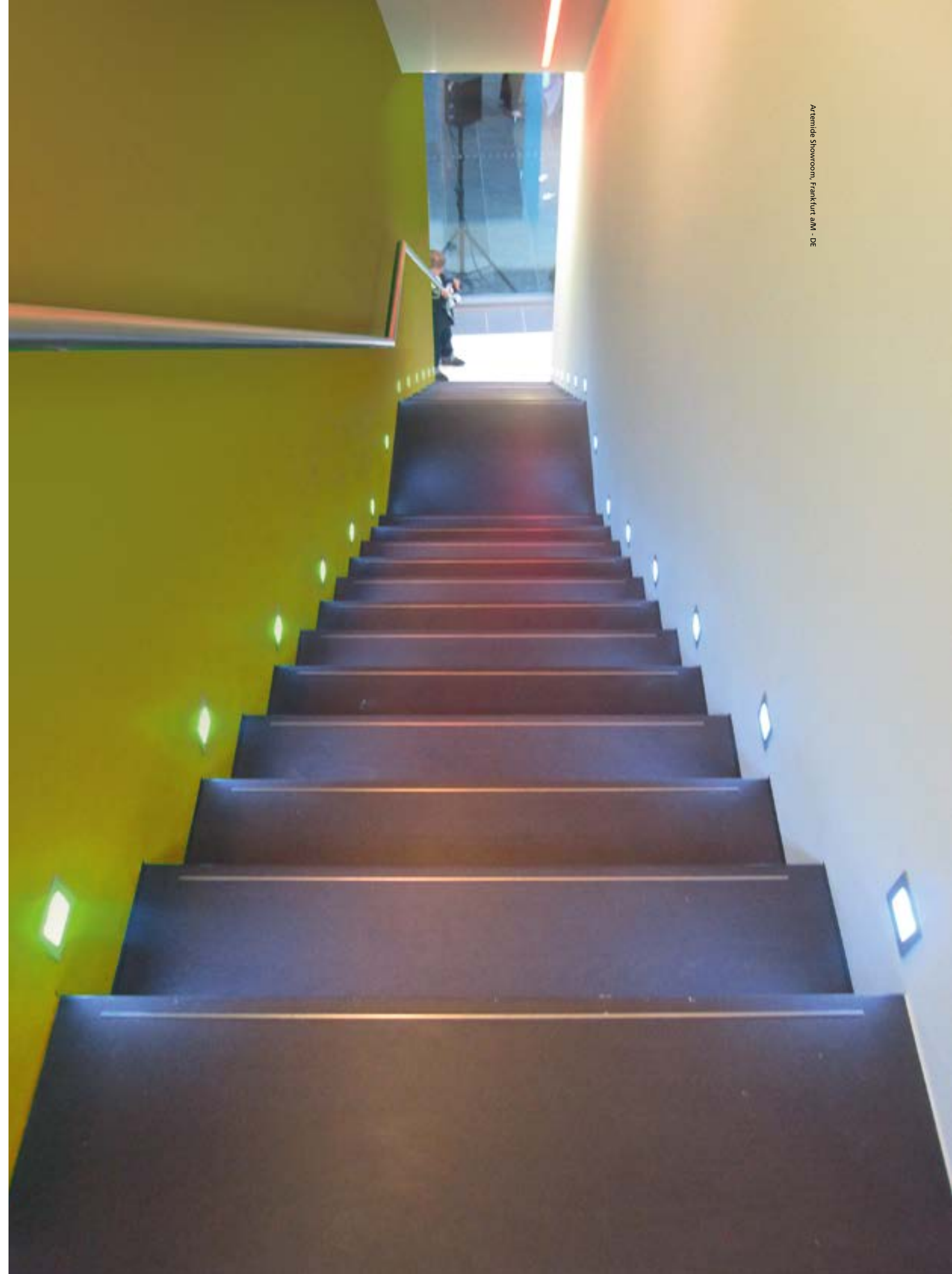

# Faci

Ernesto Gismondi  
↪ 2012

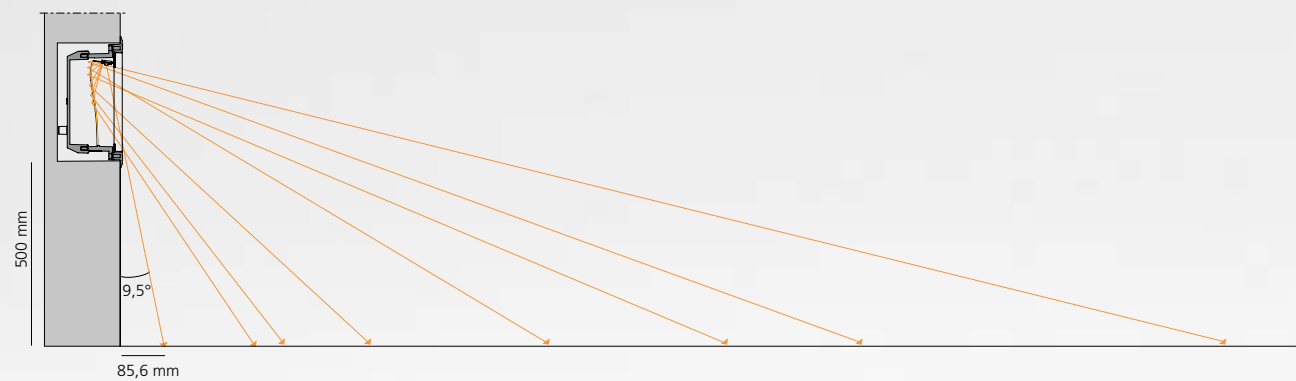

For further information on Faci  
↪ visit [artemide.com](http://artemide.com)



**Recessed hole**  
Faci 12  
160 x 160 x 80 mm  
Faci 24  
280 x 160 x 80 mm  
Faci 36  
400 x 160 x 80 mm

**Recessing box**  
Faci 12  
135 x 137 x 75 mm  
Faci 24  
256 x 137 x 75 mm  
Faci 36  
376 x 137 x 75 mm

**Body in nylon reinforced with fibre glass**

**Reflector in optic aluminium with high coefficient of reflection + strip LED**

**Tempered glass and chromed zamak frame**

Light fixture with high-performance LED light sources.  
Recessed wall installation.

3 sizes (120, 240 and 360 mm length).

Consist of by lamp body and recessing box.

Body in high-resistance reinforced polymer. The lamp body is snap-fitted into the recessing box, then it is fixed by means of two anti-vandal screws Torx. This product is suitable for areas at risk of vandalism.

Aluminium reflector conveying and diffusing the light flow downwards to ensure an even floor lighting and visual comfort without glare.

Diffuser in 8mm-thick silkscreened tempered glass to ensure higher vandal-proof resistance.

Front frame in chromed zamac.

Recessing box for laying in reinforced polymer, with low depth, can be ordered separately.





Wiring inside the lamp body with IP65 grommet suitable for cables with a diameter of 8-12 mm for the connection to the mains.

AISI 316 setscrews and silicone seal gaskets.

Technical features of light fixtures in compliance with EN60598-1.

Installation must be carried out by specialized personnel. Carefully follow the instructions.

↪ F A C I

Polished 	EL 	220/240Vac 50/60Hz electronic ballast 50/60Hz included	IP65  IK10 
---	---	---	--

FACI 12

W	Weight	Beam	Flux	CCT	Code
3 W	0,6 kg	AS	62 lm	3000K	<b>T417400W00</b>

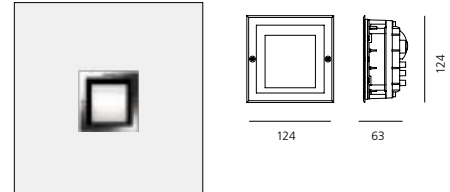

Accessories	Code
Recessing box 135x137x75 mm	<b>T409921</b>

 160x160x80h

FACI 24

W	Weight	Beam	Flux	CCT	Code
7 W	0,84 kg	AS	189 lm	3000K	<b>T417600W00</b>

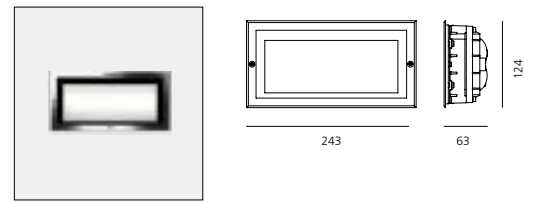

Accessories	Code
Recessing box 256x137x75 mm	<b>T409922</b>

 280x160x80h

FACI 36

W	Weight	Beam	Flux	CCT	Code
9 W	1,16 kg	AS	265 lm	3000K	<b>T417800W00</b>

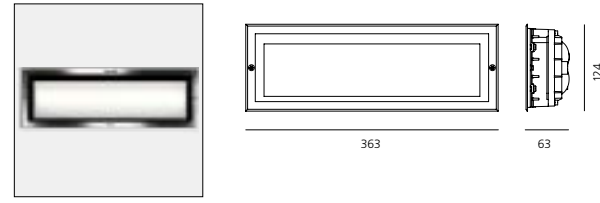

Accessories	Code
Recessing box 376x137x75 mm	<b>T409923</b>

 400x160x80h



Centro Servizi dello Studentato Universitario - Trento - IT  
 Project Studio Palerm and Fabares de Nava s.r.l. Architetti + CIA SIS Engineering Ing Luca Marini

# Faci vetro

Ernesto Gismondi

↪ 2012



**Recessed hole**  
Faci 12  
160 x 160 x 80 mm  
Faci 24  
280 x 160 x 80 mm  
Faci 36  
400 x 160 x 80 mm



**Recessing box**  
Faci 12  
135 x 137 x 75 mm  
Faci 24  
256 x 137 x 75 mm  
Faci 36  
376 x 137 x 75 mm



**Lighting unit**

Light fixture with high-performance LED light sources.  
Recessed wall installation.

Consist of 3 sizes (120, 240 and 360mm length).

Composed by lamp body and recessing box.

Body in high-resistance reinforced polymer. The lamp body is snap-fitted into the recessing box, so the final product has no visible screws and the glass is flush with the wall.

Aluminium reflector conveying and diffusing the light flow downwards to ensure an even floor lighting and visual comfort without glare.

Diffuser in 6mm-thick silkscreened tempered glass.

Recessing box for laying in reinforced polymer, with low depth, can be ordered separately.

Wiring inside the lamp body with IP65 grommet suitable for cables with a diameter of 8-12mm for the connection to the mains.





AISI 316 setscrews and silicone seal gaskets.

Technical features of light fixtures in compliance with EN60598-1.



For further information on Faci vetro  
↪ visit [artemide.com](http://artemide.com)

↪ FACI VETRO

Black glass 	EL 	220/240Vac 50/60Hz electronic ballast 50/60Hz included	IP65  IK10 
--	---	---	--

FACI VETRO 12

W	Weight	Beam	Flux	CCT	Code
3 W	0,6 kg	AS	62 lm	3000K	<b>T417500W00</b>

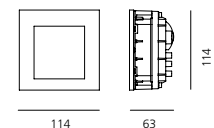
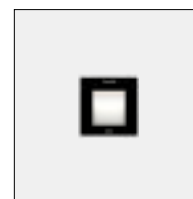



 160x160x80h

Accessories	Code
Recessing box 135x137x75 mm	<b>T409921</b>

FACI VETRO 24

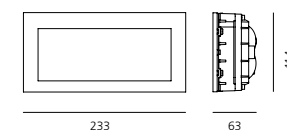
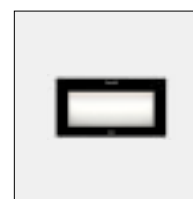
W	Weight	Beam	Flux	CCT	Code
5 W	0,84 kg	AS	189 lm	3000K	<b>T417700W00</b>





 280x160x80h

Accessories	Code
Recessing box 256x137x75 mm	<b>T409922</b>

FACI VETRO 36

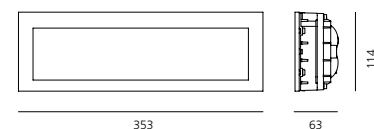
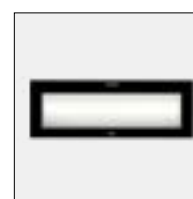
W	Weight	Beam	Flux	CCT	Code
9 W	1,16 kg	AS	265 lm	3000K	<b>T417900W00</b>



 400x160x80h

Accessories	Code
Recessing box 376x137x75 mm	<b>T409923</b>



Centro Servizi dello Studentato Universitario, Trento - IT  
 Project: Studio Palerm and Tabares de Nava s.L. Arquitectos + CLA S&S Engineering, Ing Luca Masini

# Projector



- Minispot \_\_\_\_\_ 858
- Ego Spot \_\_\_\_\_ 862
- Epulo \_\_\_\_\_ 866
- Falange \_\_\_\_\_ 870
- Obice \_\_\_\_\_ 874



# Minispot

↪ 2007





Light fixture with high-performance LED light sources.  
 Ground, floor, wall installation.  
 Consists of body, metal ring, diffuser in opaline polycarbonate, 3mm thick.  
 Body and metal ring in anticorrosive aluminium, anodized.  
 Silicone o-ring gaskets.  
 Remote driver supplied separately.  
 Power connection to the driver by means of H05RN-F cable and IP68 electrical terminal board, supplied with the fixture.  
 Fixed optic. PMMA lenses in 3 different versions of beams.  
 Picket for ground installation.  
 Technical features of light fixtures in compliance with EN60598-1 and part 2-5.  
 Installation must be carried out by specialized personnel.



For further information on Minispot  
 ↪ visit [artemide.com](http://artemide.com)



## ↪ MINISPOT

Silver grey 	F  WF 	Driver 700mA SELV supplied separately	MacAdam 3SDCM Life L70 (6K)=50000h CRI =80	IP65  +/-150° 
--	--	---------------------------------------	--	---

W	Weight	Beam	Flux	CCT	Code
2W	0,19 kg	F 24°	99 lm	3000 K	<b>NL702910K0</b>
		WF 32°	95 lm	3000 K	<b>NL702925K0</b>
		WF° 45	114 lm	3000 K	<b>NL7029ELK0</b>

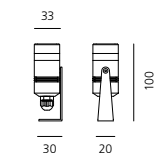

Accessories	Code
Picket in anodised metal 37 x 180mm	<b>NL97150</b>

Driver	V(ac)	L <sub>mm</sub>	W <sub>mm</sub>	H <sub>mm</sub>	IP	N°	DIM	Code
cc 14 W 700mA	220-240	79	38	25	67	1 - 5	-	<b>DV3003</b>
cc 30 W 700mA	220-240	120	38	25	67	7 - 12	-	<b>DV3004</b>
cc 38W 700mA	220-240	185	35	33	67	3 - 13	DALI	<b>DV1042</b>



Private residence, Milan - IT, interior design: Erna Corbetta. Ph. Beppe Raso









Private residence, Milan - IT, interior design: Erna Colbetta, Ph: Peppe Raso

# Ego Spot

↳ 2005



## ↳ EGO SPOT

Silver grey 	S F EL   	Driver 24Vdc SELV supplied separately	MacAdam 3SDCM Life L70 (6K)=50000h CRI = 80	IP65  ±90°
--	---	--	---	---

W	Weight	Beam	Flux	CCT	Code
12 W	0,75 kg	S 10°	755 lm	3000K	<b>T7633SPW00</b>
		F 26°	711 lm	3000K	<b>T7633FLW00</b>
		EL	723 lm	3000K	<b>T7633ELPTW00</b>

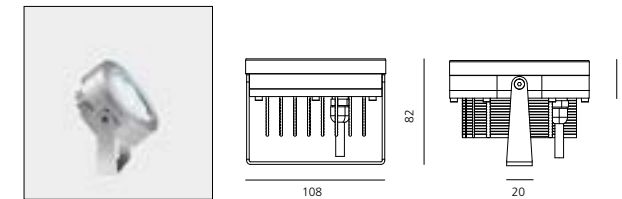

Accessories	Code
Picket	<b>NL97150</b>

Driver	Vdc	IP	LxWxH	24W	DIM	Code
24W	24Vdc	IP67	185x35x35	1	DALI	<b>DV1041</b>
25W	24Vdc	IP67	148x40x32	1		<b>T409996</b>
60W	24Vdc	IP67	163x43x32	4		<b>T409998</b>
90W	24Vdc	IP67	161x61x36	6		<b>T409999</b>
150W	24Vdc	IP67	228x68x39	10		<b>DV5004</b>
288W	24Vdc	IP20	156x52x26		DALI/PUSH/1-10/0-10 DIMMER	<b>NL19096</b>

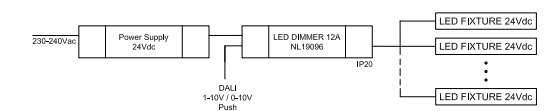

**Spot optic**  
Concentrated luminous flow to highlight details avoiding unwanted light dispersion.



**Flood optic**  
Medium luminous flux to highlight details, large sections of windows.



**Elliptical optic**  
Elliptical distribution of the luminous flow suitable for wallwasher effect.

Light fixture with high-performance LED light sources.  
Ground, floor, wall installation.  
Consists of body, frame, glass and bracket.  
Aluminium folded sheet bracket. All aluminium components are anodized.  
Diffuser in glass, 10mm-thick.  
Gaskets in EPDM.  
Remote driver supplied separately.

Power connection to the driver by means of H05RN-F cable and IP68 electrical terminal board, supplied with the fixture.  
Fixed optic. PMMA lenses in 3 different versions of beams.  
Picket for ground installation in galvanized sheet iron.  
Painted aluminium with 2-stage outdoor treatment: antioxidant primer, polyester paint.  
Technical features of light fixtures in compliance with EN60598-1 and part 2-13.  
Installation must be carried out by specialized personnel.



For further information on Ego Spot  
↳ visit [artemide.com](http://artemide.com)



Hotel Château Monfort, Milan - IT, Arch. Sofia Vedani + FZI Interiors, ph. Stefano Oppo

# Epulo





Ernesto Gismondi  
↪ 2005



For further information on Epulo  
↪ visit [artemide.com](http://artemide.com)



## ↪ EPULO

Grey-white RAL9002 00 	Anthracite grey 10 	XS 	WF 	EL 	220/240Vac 50/60Hz electronic ballast included	MacAdam 4SDCM Life L70 (4K) 60500h CRI = 80	45° (right/left) 90° (up/down) 180°	IP65 IK06
--	---	---	---	---	---	---	---	--------------

### EPULO 13

W	Weight	Beam	Flux	CCT	Code
23W	2,71 kg	XS 6°	1231 lm	3000K	<b>T418910W.00/10</b>
		WF 40°	1187 lm	3000K	<b>T418939W.00/10</b>
		EL	1198 lm	3000K	<b>T4189ELW.00/10</b>

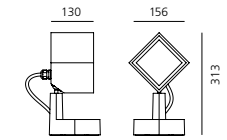

### EPULO 18

W	Weight	Beam	Flux	CCT	Code
38W	5,00 kg	XS 6°	2188 lm	3000K	<b>T418810W.00/10</b>
		WF 40°	2110 lm	3000K	<b>T418839W.00/10</b>
		EL	2136 lm	3000K	<b>T4188ELW.00/10</b>

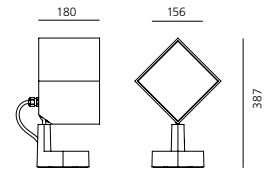

**Extra Spot optic 6°**  
Concentrated luminous flow to highlight details avoiding unwanted light dispersion.



**Wide Flood optic 40°**  
Wide luminous flow suitable for lighting large areas.



**Elliptical optic EL**  
Elliptical distribution of the luminous flow suitable for wall washer effect.

Light fixture with adjustable direct emission, with high-performance LED light sources.

Floor, wall and eaves installation.

2 sizes: Epulo 13 and Epulo 18.

Available in two finishes: grey-white painted (RAL 9002) and anthracite grey painted.

Consists of lighting unit, terminal board and fixing bracket. Rotation on the base +/-180°, side body tilt +/-45° and front body tilt +/-90° by means of a spherical joint allowing an accurate adjustment.

Body and terminal board in EN AB-47100 aluminium, fixing bracket in stainless steel, silicone gaskets. Electronic ballast integrated in the body.

Silkscreened tempered glass siliconed flush with the body to avoid backwater.

The device is provided with a safety cable with hook to allow easy wiring during its installation in any position.

IP67 connector for electric connection to the mains, it can be housed in the terminal board compartment and is suitable for cables with a diameter of 5-13.5mm.

PMMA lenses in 3 different versions of beams.

Screws in AISI 316 stainless steel.

The components in die-cast aluminium and the steel bracket are painted with 3-stage outdoor treatment: nanotechnologies, antioxidant primer, polyester paint.

Technical features of light fixtures in compliance with EN60598-1 and part 2-5.



# Falange

Wilmotte & Industries

↪ 2011

Adjustable light fixture with direct emission, with high-performance LED light sources.

Ground, wall, eaves installation.

2 sizes: 134x134, 238x134 mm.

Composed by adjustable lighting unit and support (housing the wiring) by means of a graduated metal ring allowing an accurate adjustment. Positioning is maintained by means of locking dowels.

Body and support in EN AB44100 aluminium, silicone gaskets.

Electronic ballast integrated in the body.

Silkscreened tempered glass siliconed to a secondary frame.

Wiring to be carried out by means of plug IP 68.

PMMA lenses in 3 different versions of beams.

AISI 316 stainless steel screws.

Painted die-cast aluminium with 3-stage outdoor treatment: nanotechnologies, antioxidant primer, polyester paint.

Technical features of light fixtures in compliance with EN60598-1 and part 2-5.



For further information on Falange  
↪ visit [artemide.com](http://artemide.com)





## ↪ FALANGE

Grey-white RAL9002 02	Anthracite grey 05	S	WF	EL	220/240Vac 50/60Hz electronic ballast included	MacAdam 4SDCM Life L70 (10K)>60500h CRI =80	IP65 ⊕ 180° 60°
-----------------------------	--------------------------	---	----	----	---	---	-----------------------

### FALANGE 9

W	Weight	Beam	Flux	CCT	Code
22 W	2,00 kg	S 10°	958 lm	3000K	<b>NL3000010K0.</b> 02/05
		WF 34°	764 lm	3000K	<b>NL3000039K0.</b> 02/05
		EL	830 lm	3000K	<b>NL30000ELK0.</b> 02/05

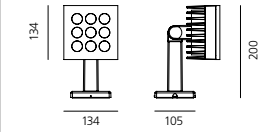

### FALANGE 18

W	Weight	Beam	Flux	CCT	Code
44 W	3,05 kg	S 10°	1917 lm	3000K	<b>NL3000110K0.</b> 02/05
		WF 34°	1529 lm	3000K	<b>NL3000139K0.</b> 02/05
		EL	1661 lm	3000K	<b>NL30001ELK0.</b> 02/05

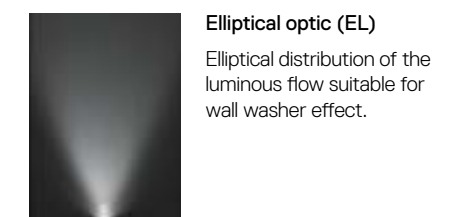
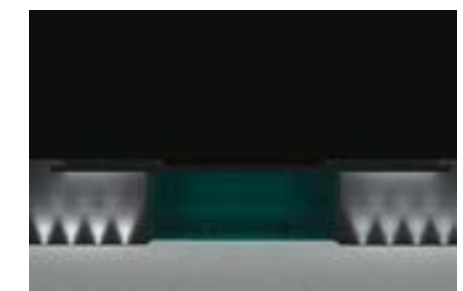
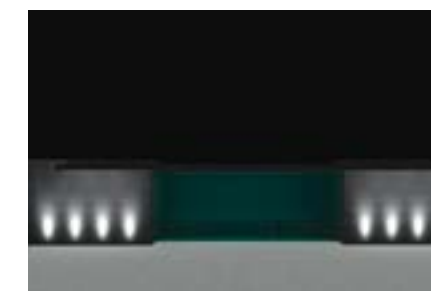
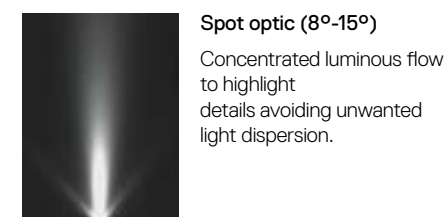
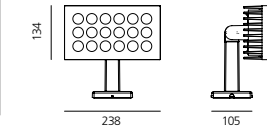



# Obice

Alessandro Pedretti  
(Studio Rota & Partners)  
↔ 2014, 2016



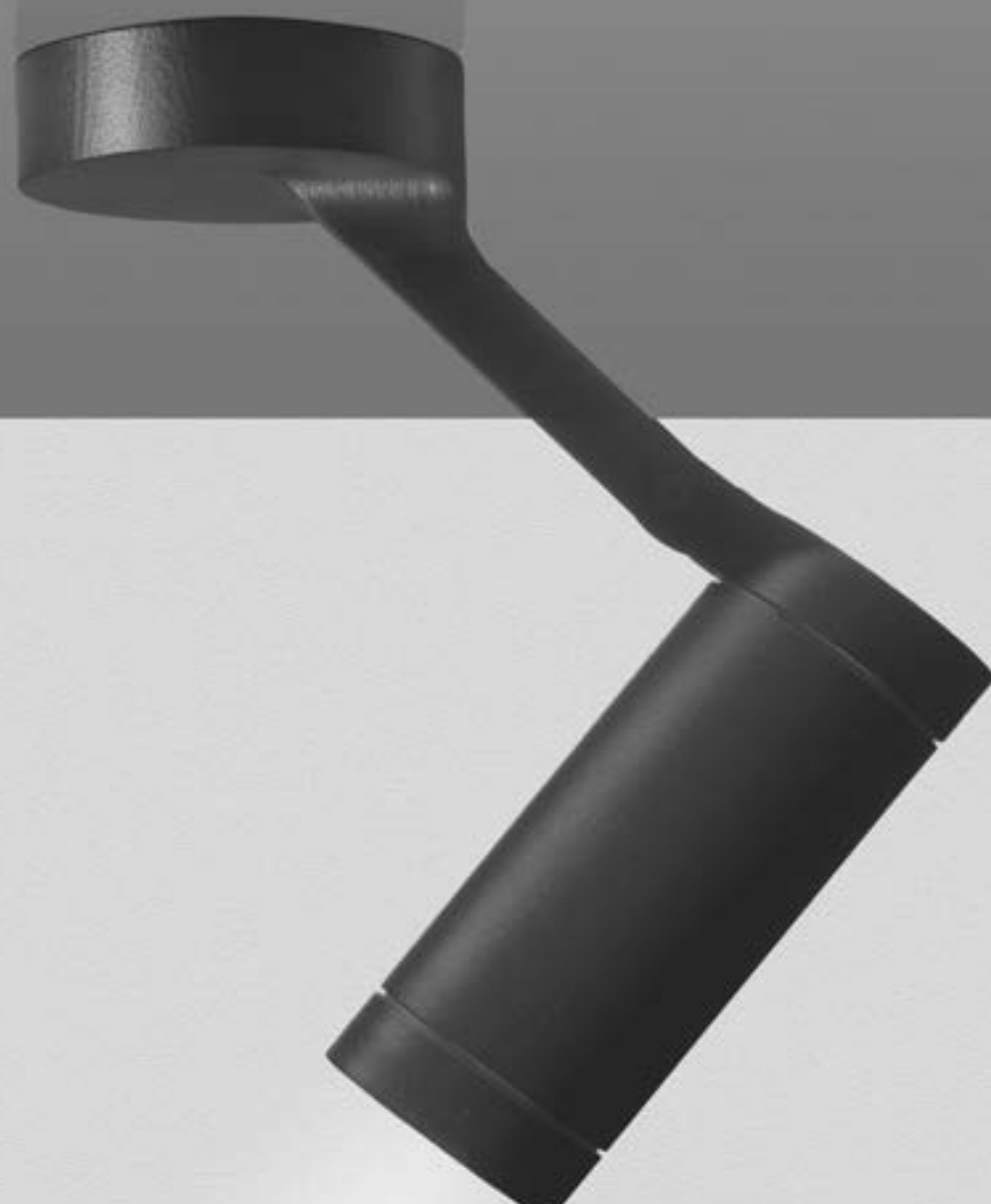

↪ OBICE

White □ 20	Black ■ 10	F ●	WF ●	220/240Vac 50/60Hz electronic ballast included	Life L80 (13K) 78600h CRI = 80	IP40 / IP65 INK06  +35°/-125° 359°
------------------	------------------	--------	---------	---	-----------------------------------	---

OBICE

W	Weight	Beam	Flux	CCT	Code
10 W	1,24 kg	19°	670 lm	3000 K	<b>T430518W.</b> 10/20
		34°	605 lm	3000 K	<b>T430534W.</b> 10/20

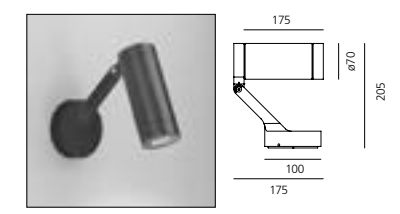

IP65  
MacAdam 2SDC  
Life = L70(6K)>36000

OBICE MINI

W	Beam	Flux	CCT	Code
7 W	19°	505 lm	3000 K	<b>T430418W.</b> 10/20
	34°	460 lm	3000 K	<b>T430434W.</b> 10/20

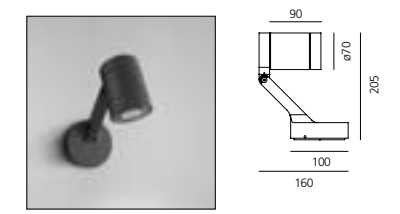

IP65  
MacAdam 2SDC  
Life = L70(6K)>36000

Driver 24Vdc SELV supplied separately

Driver	Vdc	IP	LxWxH	7W	DIM	Code
24W	24Vdc	IP67	185x35x35	1	DALI	<b>DV1041</b>
25W	24Vdc	IP67	148x40x32	3		<b>T409996</b>
60W	24Vdc	IP67	163x43x32	7		<b>T409998</b>
90W	24Vdc	IP67	161x61x36	10		<b>T409999</b>
150W	24Vdc	IP67	228x68x39	18		<b>DV5004</b>
288W	24Vdc	IP20	156x52x26		DALI/PUSH/1-10/0-10 DIMMER	<b>NL19096</b>

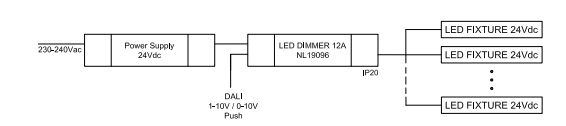



OBICE MICRO

W	Weight	Beam	Flux	CCT	Code
3 W	0,28 kg	23°	112 lm	3000 K	<b>M3160FLW.</b> 10/20
		32°	115 lm	3000 K	<b>M3160WFLW.</b> 10/20

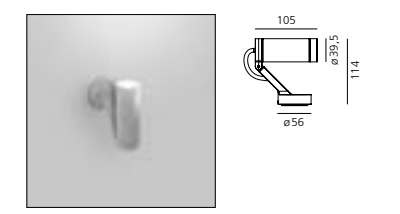
IP40	Code
IP40	<b>M3160FLW.</b> 10/20
IP65	<b>T4314FLW.</b> 10/20
IP65	<b>T4314WFLW.</b> 10/20



MacAdam 4SDC  
Life = L70(6K)>50000

Accessories	Code
 Accessories holder	<b>T4306000.</b> 10/20
 Lens for elliptical emission	<b>T430700000</b>



For further information on Obice  
↪ visit [artemide.com](http://artemide.com)

Lights fixture with high-performance LED light sources.  
Wall / ceiling installation.  
Monochromatic light.  
Consist of: body, adjustable joint, terminal board and protective screen.  
Body in injection mould of aluminium.  
Terminal base and adjustable joint in injection mould of aluminium.  
Flange, protection screen in tempered glass, 4mm-thick, with black opal serigraphy.  
Integrated power supply (Obice e Obice Micro), 24Vdc remote driver included (Obice mini).  
Wiring to be carried out by means of a plug (IP68) located in the terminal base (only for Obice and Obice Micro).  
Technical features of light fixtures in compliance with EN60598-1.

# Scenographic Lighting



Spike \_\_\_\_\_ 880

LineaLed

drive over \_\_\_\_\_ 884

LineaLed

wallwasher \_\_\_\_\_ 888

Dedalo \_\_\_\_\_ 892



# Spike

↪ 2006



Lighting appliance with high-yield LED sources.

Wall or ceiling mounted.

Monochrome or RGB light.

EN AW6060 T5 extruded aluminium body.

3mm-thick methacrylate diffuser.

Die-cast aluminium caps with silicon rim.

EN AB 47100 aluminium adjustment brackets.

Power unit connection with bipolar H05RN-F cable (monochrome) or quadripolar silicon/rubber cable (RGB), with standard IP 68 clamp.

Remote 24 Vdc power unit.

Body in anodized extruded aluminium. Caps and brackets in painted die-cast aluminium with 3-stage outdoor treatment: nanotechnologies, anti-oxidant primer, polyester paint.

Optional painted extruded aluminium anti-glare screen.

Optical units. PMMA lenses with 3 different beam options.

RGB version made up of monochrome red, green and blue LEDs.

Technical specifications of EN60598-1 compliant appliances.



For further information on Spike  
↪ visit [artemide.com](http://artemide.com)



## ↳ SPIKE

Silver grey    S    F    EL    24Vdc power supplied separately.  
\* new version longer than 4 mm.    MacAdam 4SDCM    IP65  
Life L90 (9K) >54400h  
CRI =80

### SPIKE

Watt	Lenght	Weight	Beam	Flux	CCT	Code
12W	268 mm*0,37 kg		S13°	594 lm	3000K	<b>T430010W00</b>
			F 27°	554 lm	3000K	<b>T430025W00</b>
			EL	594 lm	3000K	<b>T4300ELW00</b>
24W	490 mm*0,75 kg		S13°	1188 lm	3000K	<b>T430110W00</b>
			F 27°	1108 lm	3000K	<b>T430125W00</b>
			EL	1188 lm	3000K	<b>T4301ELW00</b>
36W	730 mm*1,06 kg		S13°	1782 lm	3000K	<b>T430210W00</b>
			F 27°	1662 lm	3000K	<b>T430225W00</b>
			EL	1782 lm	3000K	<b>T4302ELW00</b>
48W	970 mm*1,34 kg		S13°	2376 lm	3000K	<b>T430310W00</b>
			F 27°	2216 lm	3000K	<b>T430325W00</b>
			EL	2376 lm	3000K	<b>T4303ELW00</b>

### Antidazzle screen

	Code
Spike 12W	<b>T430806</b>
Spike 24W	<b>T430812</b>
Spike 36W	<b>T430818</b>
Spike 48W	<b>T430824</b>

Driver	Vdc	IP	LxWxH	12W	24W	36W	48W	DIM	Code
24W	24Vdc	IP67	185x35x35	1				DALI	<b>DV1041</b>
25W	24Vdc	IP67	148x40x32	1				-	<b>T409996</b>
60W	24Vdc	IP67	163x43x32	4	2	1	1	-	<b>T409998</b>
90W	24Vdc	IP67	161x61x36	6	3	2	1	-	<b>T409999</b>
150W	24Vdc	IP67	228x68x39	1	5	3	2	-	<b>DV5004</b>
288W	24Vdc	IP20	156x52x26					DALI/PUSH/1-10/0-10 DIMMER	<b>NL19096</b>

### SPIKE RGB

Watt	Lenght	Weight	Beam	Code
25W	784 mm*1,06 kg		S10°	<b>NL5003110C002</b>
			F 25°	<b>NL5003130C002</b>
			EL	<b>NL50031ELC002</b>
			40°	<b>NL5003140C002</b>

Driver	Vac	W	Vdc	Ch	Control	LxWxH	IP	25W	Code
Driver NLX1-100	120-250Vac	95W	24Vdc PWM	1xRGB	DMX/DALI	388x42x30	40	3 max	<b>NL12150</b>
Driver NLX1-75		144W	24Vdc PWM	1xRGB	DMX/DALI	153x50x23	40		<b>NL19084</b>
PUS 150W	90-305Vac	150W	24Vdc			228x68x39	67	5 max	<b>DV5004</b>
Driver NLX2-75	90-260Vac	75W	24Vdc PWM	2xRGB	DMX	270x200x80	40	3 max	<b>NL75190</b>
Driver NLX1-100 IP	120-250Vac	95W	24Vdc PWM	1xRGB	DMX/DALI	340x103x61	66	3 max	<b>DV1046</b>

**Code**  
**NL19030**

DSC 30 USB interfaced DMX stand alone  
Digital interface provided with software. If connected to the PC USB port, it transforms the programme instructions into DMX 512 control signals.  
DSC30 (512 DMX controllable channels, real-time clock, local use) allows computer-interactive programming and stand-alone mode, that is the possibility of autonomous interface repetition without PC connection.

9V/350mA ballast with mini USB connector for DSC30    **NL19031**

50cm-long cable with HE10 connector for connection to a keyboard    **NL7833**

Antidazzle screen    **T430836**

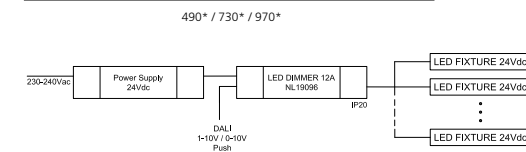
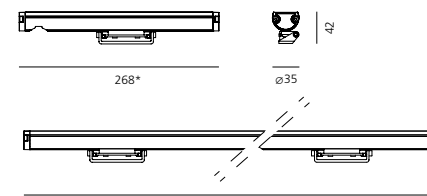
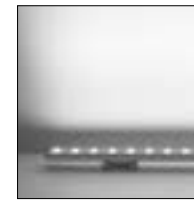

Code
<b>DV1041</b>
<b>T409996</b>
<b>T409998</b>
<b>T409999</b>
<b>DV5004</b>
<b>NL19096</b>



16,7 M

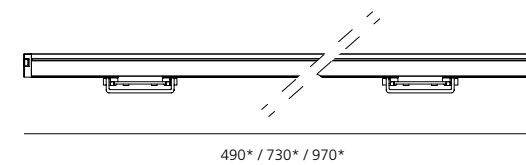

9V/350mA ballast with mini USB connector for DSC30    **NL19031**

50cm-long cable with HE10 connector for connection to a keyboard    **NL7833**

Antidazzle screen    **T430836**

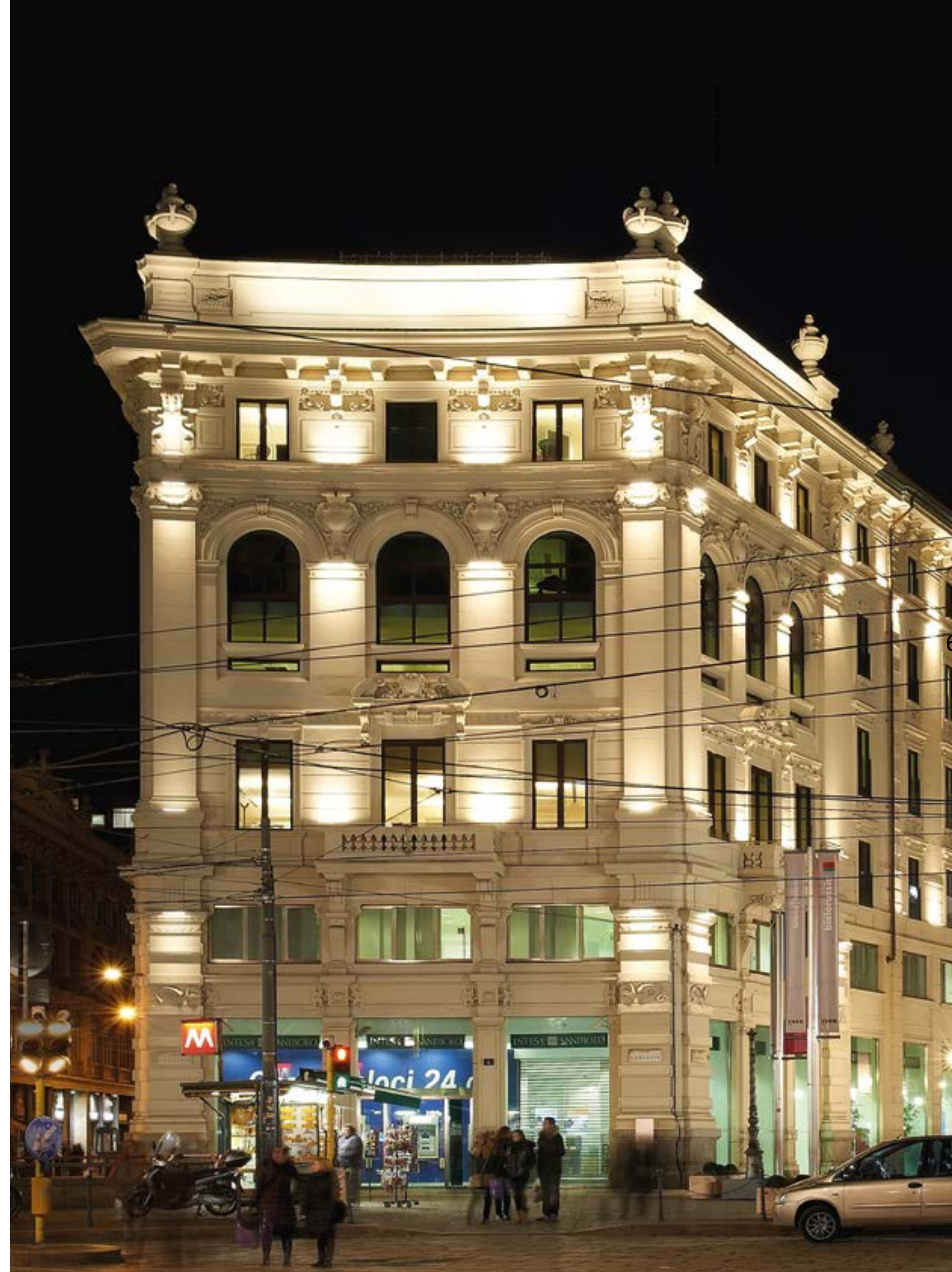

# LineaLed - Drive over

Carlotta de Bevilacqua

↪ 2010



Walk over and drive over approved up to 5000Kg.  
Light fixture with high-performance LED light sources.  
Walk-over and drive-over recessed floor installation.  
Monochromatic or RGB light.  
Composed of body, diffuser, recessing box, closing end caps, junctions.  
Body in extruded EN AW6060 T5 aluminum.  
Opal non-slippery tempered glass 8mm-thick.  
Glass surface temperature lower than 35°.  
Profile end caps in aluminum EN AW 6060.  
Recessing box for laying in stainless steel AISI 304.

Recessing box end caps and junction in stainless steel AISI 304.  
Electrical connection to the ballast by means of a two-pole cable H05RN-F, with IP68 quick-release terminal block which is supplied with the fixture and can be housed in the recessing box.  
24Vdc remote ballast.  
Body fastened to the recessing box by means of proper pre-stressed steel springs supplied with the fixture.  
Painted profile with 2-stage outdoor treatment: primer, outdoor paint.  
RGB version with Full Colour RGB LEDs.  
Technical features of light fixtures in compliance with EN60598-1.



For further information on LineaLed - Drive-over  
↪ visit [artemide.com](http://artemide.com)

## ↳ LINEALED DRIVE OVER

Silver grey 	XF 	24Vdc power supplied separately.	MacAdam 7SDCM Life L70 (6K)=35000h CRI =75	IP65 / IP67 
--	---	----------------------------------	--	--

### LINEALED

W	Length	Beam	Flux	CCT
5W	618 mm	XF	115 lm	3000K
8W	978 mm	XF	206 lm	3000K

Code
NL7398VSKO
NL7419VSKO

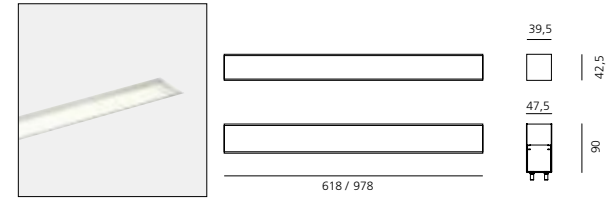

Driver	Vdc	IP	LxWxH	12W	24W	36W	48W
24W DALI	24Vdc	IP67	185x35x35	4			
25W	24Vdc	IP67	148x40x32	1			
60W	24Vdc	IP67	163x43x32	4	2	1	1
90W	24Vdc	IP67	161x61x36	6	3	2	1
150W	24Vdc	IP67	228x68x39	1	5	3	2
288W DIMMER	24Vdc	IP20	156x52x26				

Code
DV1041
T409996
T409998
T409999
DV5004
NL19096

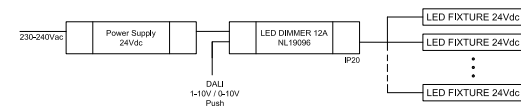

Maximum linear length of a series of products with one supply line: 6m.  
For lines of length exceeding 6m, provide multiple supply lines.

### LINEALED RGB

W	Length
10W	618mm
16W	978mm

Code
NL76480
NL76490

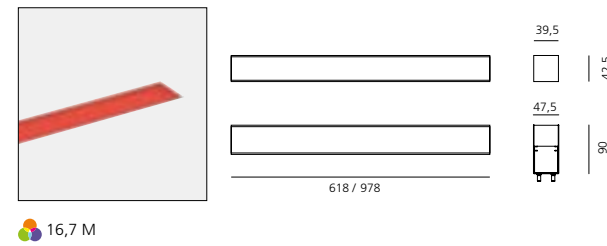

Driver	Vac	W	Vdc	Ch	Control	LxWxH	IP	25W	Code
Driver NLX1-100	120-250Vac	95W	24Vdc PWM	1xRGB	DMX/DALI	388x42x30	40	3 max	NL12150
Driver NLX1-75		144W	24Vdc PWM	1xRGB	DMX/DALI	153x50x23	40		NL19084
PUS 150W	90-305Vac	150W	24Vdc			228x68x39	67	5 max	DV5004
Driver NLX2-75	90-260Vac	75W	24Vdc PWM	2xRGB	DMX	270x200x80	40	3 max	NL75190
Driver NLX1-100 IP	120-250Vac	95W	24Vdc PWM	1xRGB	DMX/DALI	340x103x61	66	3 max	DV1046

PWM driver for fixtures with autonomous colour programmers for stand-alone or controlled working by means of DMX 512 protocol for installations of all sizes.

Code
DSC 30 USB interfaced DMX stand alone
NL19030

Digital interface provided with software. If connected to the PC USB port, it transforms the programmers instructions into DMX 512 control signals.  
DSC30 (512 DMX controllable channels, real-time clock, local use) allows computer-interactive programming and stand-alone mode, that is the possibility of autonomous interface repetition without PC connection.

9V/350mA ballast with mini USB connector for DSC30	NL84100
--	---------

50cm-long Cable with HE10 connector for connection to a keyboard	NL77270
--	---------

Accessories	Code
Housing L=622mm	NL76720
Housing L=982mm	NL76700
Continuity joint - 80 x 50 x 1,5mm	NL75810
Housing end cap (pair) - 46,5 x 62,5 x 1,5mm	NL76750
Power supply connector & connector end cap	NL19052

Female power connector for discontinuous connection	NL19023
---	---------

Male power connector for discontinuous connection	NL19021
---	---------

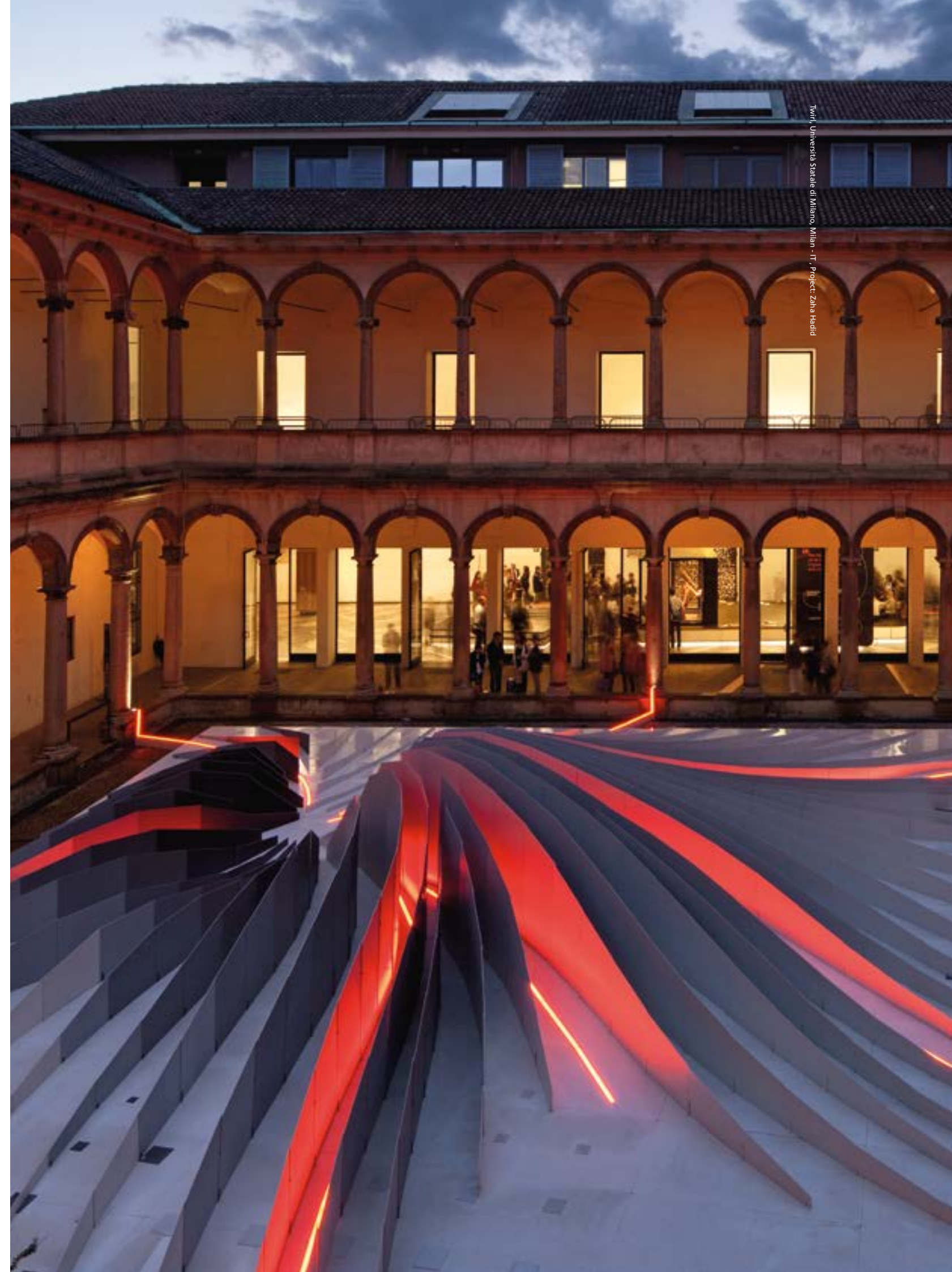

Tutti, Università Statale di Milano, Milano - IT, Project: Zaha Hadid

# LineaLed - Wallwasher

Carlotta de Bevilacqua

↪ 2011

Walk over and drive over approved up to 5000Kg.  
Light fixture with high-performance LED light sources.

LineaLed Wallwasher: walk-over and drive-over recessed floor installation. Consist of body, diffuser, recessing box, closing end caps, junctions. Body fastened to the recessing box by means of proper pre-stressed steel springs supplied with the fixture.

LineaLed Wallwasher adjustable: Wall or ceiling installation. Consist by body in extruded aluminium, protection glass, adjustable die-cast aluminium brackets.

Body in extruded EN AW6060 T5 aluminium.

Transparent non-slippery tempered glass 8mm-thick. Glass surface temperature lower than 50°.

Profile end caps in injection-mould polycarbonate with silicone gasket.

Recessing box for laying, recessing box end caps and junction in stainless steel AISI 304.

Electrical connection to the ballast by means of a two-pole cable H05RN-F; with IP68 quick-release terminal block which is supplied with the fixture and can be housed in the recessing box (LineaLed Wallwasher) or with IP68 terminal board supplied with the fixture (LineaLed Wallwasher adjustable).

24Vdc remote ballast.

Optics. PMMA lenses in 3 different versions of beams.

Painted profile and brackets with 2-stage outdoor treatment: primer, outdoor paint.

Technical features of light fixtures in compliance with EN60598-1.







For further information on LineaLed - Wallwasher  
↪ visit [artemide.com](http://artemide.com)



Palazzo Via Manzoni, Milan - IT, Project: Studio Pivato S.p.A, arch. Cristina Pivato

## ↳ LINEALED WALLWASHER

Silver grey 	S  F  EL 	Driver 24Vdc SELV supplied separately.	MacAdam 2SDCM Life L70 (6K)=50000h CRI =80	IP65/ IP67  IK07
--	--	---	--	---

### LINEALED WALLWASHER

W	Length	Weight	Beam	Flux	CCT	Code
8,5 W	300 mm	0,9 kg	S 12°	416 lm	3000K	<b>NL1732010K0</b>
			F 28°	411 lm	3000K	<b>NL1732025K0</b>
			EL	416 lm	3000K	<b>NL17320ELK0</b>
17 W	500 mm	1,5 kg	S 12°	832 lm	3000K	<b>NL1732110K0</b>
			F 28°	822 lm	3000K	<b>NL1732125K0</b>
			EL	832 lm	3000K	<b>NL17321ELK0</b>
25 W	780 mm	2,21 kg	S 12°	1248 lm	3000K	<b>NL1732210K0</b>
			F 28°	1234 lm	3000K	<b>NL1732225K0</b>
			EL	1248 lm	3000K	<b>NL17322ELK0</b>
34 W	978 mm	2,77 kg	S 12°	1665 lm	3000K	<b>NL1732310K0</b>
			F 28°	1645 lm	3000K	<b>NL1732325K0</b>
			EL	1665 lm	3000K	<b>NL17323ELK0</b>

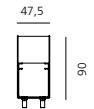
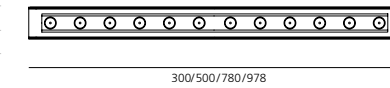
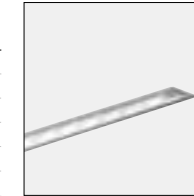

Maximum linear length of a series of products with one supply line: 2m.  
For lines of length exceeding 2m, provide multiple supply lines.  
Choose cable cross-section according to the load / maximum voltage drop 2V

### Accessories

	Code
Housing L=300mm	<b>NL76740</b>
L=500mm	<b>NL76730</b>
L=780mm	<b>NL76710</b>
L=980mm	<b>NL76700</b>
Continuity joint - 80 x 50 x 1,5mm	<b>NL75810</b>
Housing end cap (pair) - 46,5 x 62,5 x 1,5mm	<b>NL76750</b>
Power feed connector & connector end cap	<b>NL19052</b>
Female power connector for discontinuous connection	<b>NL19023</b>
Male power connector for discontinuous connection	<b>NL19021</b>

### LINEALED WALLWASHER ADJUSTABLE

W	Length	Weight	Beam	Flux	CCT	Code
8,5 W	300 mm	0,9 kg	S 12°	416 lm	3000K	<b>NL1733010K0</b>
			F 28°	411 lm	3000K	<b>NL1733025K0</b>
			EL	416 lm	3000K	<b>NL17330ELK0</b>
17 W	500 mm	1,5 kg	S 12°	832 lm	3000K	<b>NL1733110K0</b>
			F 28°	822 lm	3000K	<b>NL1733125K0</b>
			EL	832 lm	3000K	<b>NL17331ELK0</b>
25 W	780 mm	2,21 kg	S 12°	1248 lm	3000K	<b>NL1733210K0</b>
			F 28°	1234 lm	3000K	<b>NL1733225K0</b>
			EL	1248 lm	3000K	<b>NL17332ELK0</b>
34 W	978 mm	2,77 kg	S 12°	1665 lm	3000K	<b>NL1733310K0</b>
			F 28°	1645 lm	3000K	<b>NL1733325K0</b>
			EL	1665 lm	3000K	<b>NL17333ELK0</b>

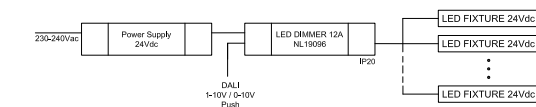
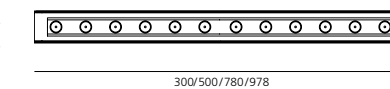
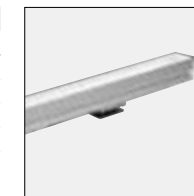

Driver	Vdc	IP	LxWxH	8,5W	17W	25W	34W	DIM	Code
24W	24Vdc	IP67	185x35x35	2	1	-	-	-	<b>DV1041</b>
25W	24Vdc	IP67	148x40x32	2	1	-	-	-	<b>T409996</b>
60W	24Vdc	IP67	163x43x32	6	3	2	1	-	<b>T409998</b>
90W	24Vdc	IP67	161x61x36	8	4	3	2	-	<b>T409999</b>
150W	24Vdc	IP67	228x68x39	12	7	5	3	DALI	<b>DV5004</b>
288W	24Vdc	IP20	156x52x26	-	-	-	-	DALI/PUSH/1-10/0-10 DIMMER	<b>NL19096</b>

### Spot optic (12°)

Concentrated luminous flow to highlight details avoiding unwanted light dispersion.



### Flood optic (28°)

Medium luminous flux to highlight details, large sections of windows.



### Elliptical optic (EL)

Elliptical distribution of the luminous flow suitable for wallwasher effect.

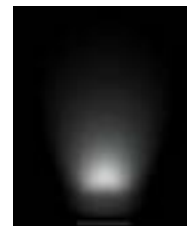





# Dedalo

↪ 2013

## ↪ DEDALO

XF 	Driver 24Vdc SELV supplied separately	MacAdam 3SDCM Life L70 (4K)=50000h CRI =80	IP65/ IP40 
---	--	--	---

### DEDALO

W	Lenght	Weight	Flux	CCT	IP65 Code	IP40 Code
24 W 300 LED	5000 mm	0,4 kg	1104 lm	3200K	NL17034VTK0	NL17032VTK0
48 W 600 LED	5000 mm	0,4 kg	2202 lm	3200K	NL17034VTK1	NL17032VTK1

24 W divisible every 100 mm  
48 W divisible every 50mm



Driver	Vac	L <sub>mm</sub>	W <sub>mm</sub>	H <sub>mm</sub>	IP	24W	48W	DIM	Code
cv 60W 24Vdc	90-305	163	43	32	67	2max	1max	-	T409998
cv 90W 24Vdc	90-305	161	61	36	67	3max	1max	-	T409999
cv 150W 24Vdc	90-305	228	68	39	67	5max	2max	-	DV5004
Dimmer 144W 12Vdc	20	156	68	39					NL19096
Dimmer 288W 24Vdc Vin 24Vdc	156	52	26	20	DALI/PUSH/	1-10/0-10			NL19096
Connection Kit (1 male - 2 female)									NL170330

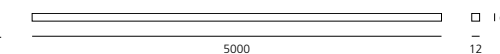

### DEDALO RGB

W	Lenght	Weight	RGB	IP65 Code	IP40 Code
60 W 240 LED	5000 mm	0,48 kg	16,7m	NL17037	NL17036

60 W divisible every 62,5 mm

Driver	Vac	W	Vdc	Ch	Control	LxWxH	IP	60W	Code	
Driver NLX1-100	120-250Vac	95W	12Vdc	PWM	1xRGB	DMX/DALI	388x42x30	40	1 max	NL12150
Driver NLX1-75		72W	12Vdc	PWM	1xRGB	DMX/DALI	153x50x23	40	1 max	NL19084
PSU 150W	90-305Vac	150W	12Vdc				228x68x39	67	1 max	DV1043
Driver NLX1-100 IP	120-250Vac	95W	12Vdc	PWM	1xRGB	DMX/DALI	340x103x61	66	1 max	DV1043

DSC 30 USB interface DMX stand alone  
9V/350mA ballast with mini USB connector for DSC30  
50cm cable with HE10 connector for keyboard (optional)

Code  
NL19030  
NL19031  
NL7833

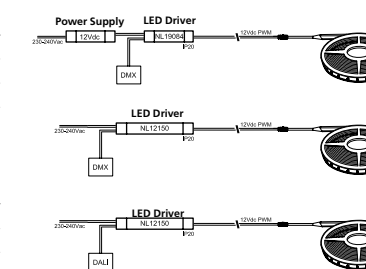

Light fixture with high-performance LED light sources.  
Ceiling, wall or floor installation.  
Flexible profile.  
Flexible UV-resistant polyurethane resin rim.  
Accurate led selection equal to 3-Step MacAdam, ensuring colour consistency.  
3M adhesive film to fix the product, supplied with the fixture.

Remote driver.  
Electrical connection to the driver by means of H05RN-F (IP65) or FEP-FEP cable (IP40), and appropriate terminal board, provided with the fixture.  
RGB Full colour LED.  
Operating temperature -20°C / +40°C.  
Technical features of light fixtures in compliance with EN60598-1.



For further information on Dedalo  
↪ visit [artemide.com](http://artemide.com)

# Places and Street Lighting



Solar Tree

2<sup>nd</sup> Generation \_\_\_\_\_ 896

Solar Tree 2.0 \_\_\_\_\_ 906

Indicta \_\_\_\_\_ 914

Poto \_\_\_\_\_ 916

Sostituto Spot \_\_\_\_\_ 918 920

Sostituto Palo \_\_\_\_\_ 920

Cefiso \_\_\_\_\_ 924

Cefiso Palo \_\_\_\_\_ 930

Cariddi \_\_\_\_\_ 934

Cariddi Palo \_\_\_\_\_ 938

# Solar Tree 2<sup>nd</sup> Generation

Ross Lovegrove  
↪ 2017

**Solar Tree 2<sup>nd</sup> Generation develops and opens up to IoT interaction, to create new scenarios and introduce new and unexpected perspectives for future smart cities.**

Solar Tree is conceived as a lighting appliance combining the LED-based lighting technique with the solar photovoltaic technology in a very peculiar and innovative design.

The project is aimed, on one hand, at minimizing the environmental impact of the product's use (deriving, in particular, from reduced consumption of energy obtained from fossil fuels), while ensuring that the appliance can provide service continuity and, therefore, the expected luminous performance, without being vulnerable to random weather agents or suffer design imbalance (number of panels, accumulator size) calculated for winter months. Such imbalance implies significant dimensions, weights, and costs and would not ensure continuous operation in off-average weather conditions.

The same logical principles implemented in the automotive sector on electric cars, with hybrid versions taking the lead over pure electric battery-based ones for a number of reasons, such as costs, performance, and state of the art of certain technologies, were used to develop the Solar Tree project by Artemide. With its mixed accumulator/solar and network configuration, it provides the best possible energy saving and functionality combination.



For further information on Solar Tree 2<sup>nd</sup> Generation  
↪ visit [artemide.com](http://artemide.com)





## CONFIGURATION

The light fitting configuration includes an analysis of the potential incoming energy (geographical location of the light fitting) and a detailed analysis of the physical location of the light fitting (proximity of buildings or trees). Lastly, an analysis of the level of requested service and performance will be implemented (luminance levels, operation hours, potential discontinuity in the service, if any).

## TECHNICAL DATA

Total number of heads with solar panels: 10  
 Solar panel voltage in open circuit: 10V max  
 Peak power for each panel: about 75 W  
 Number of heads with COB LEDs: 4  
 Installed power for each light head: 20 W at 1000mA.  
 LEDs color temperature: 3000K, 3SDCM  
 Maximum luminous flux for each head: minimum 2200 lm.  
 Total number of "stems": 10

- The structure consists of curved steel poles of different diameters and heights, reaching a maximum total 6.4m height above road level.
- The system includes 10 "grass blades" with 3mm-thick poles with a 42mm diameter, fitted with 1 1W terminal LED protected by a PMMA diffuser screen, and 10 4mm-thick poles with a 76mm diameter supporting the heads.
- The heads are composed by an anodized aluminum structure and, in the lower part, of a UV-resistant PC cover, which ensures protection against water and dust. They are all equipped with solar panels.
- The poles are painted with green epoxy paint for exteriors, with iridescent effects on a galvanized base substrate.
- Four of the ten heads (all with photovoltaic cells on the top) are fitted with a COB LED unit with a warm white colour temperature, for an asymmetric direct emission.
- The base is made of hot-zinc coated sheet steel designed for enclosure in a plinth of the appropriate size, not provided with the appliance, to be sunk into the ground. Alternatively a base is available, also made of zinc-coated steel with reinforced concrete stabilizing units forming a round seat. In this case the base can simply rest on the ground, even if ground fixing is always recommended.
- The connection/cabling elements, as well as the control and charging boards, are contained in multiple water-tight boxes with plug-and-socket connectors with protection rating IP65 or higher, and located either in appropriate spots at the foot of the base for easy inspection and maintenance, or inside the concrete stabilizing unit, as specified in detail for the Solar Tree version constituting the object of the supply.
- The airtight accumulators are contained in specific boxes that allow, on one hand, to protect the battery mechanically and from outer agents and, on the other to release any gas discharges, to be provided for by the law.

LED power for each "stem":  
 about 1 W with a power supply of 350mA.  
 2 batteries  
 Battery voltage: 12V  
 Single battery capacity: 230 Ah  
 2 batteries boxes  
 1 box for 10 light stem panels wiring connection  
 1 box of 10 luminous "stems" wiring connection  
 1 power supply and battery connection box and power supply for LED heads + luminous "stems" + wireless charging / presence sensors (optional)

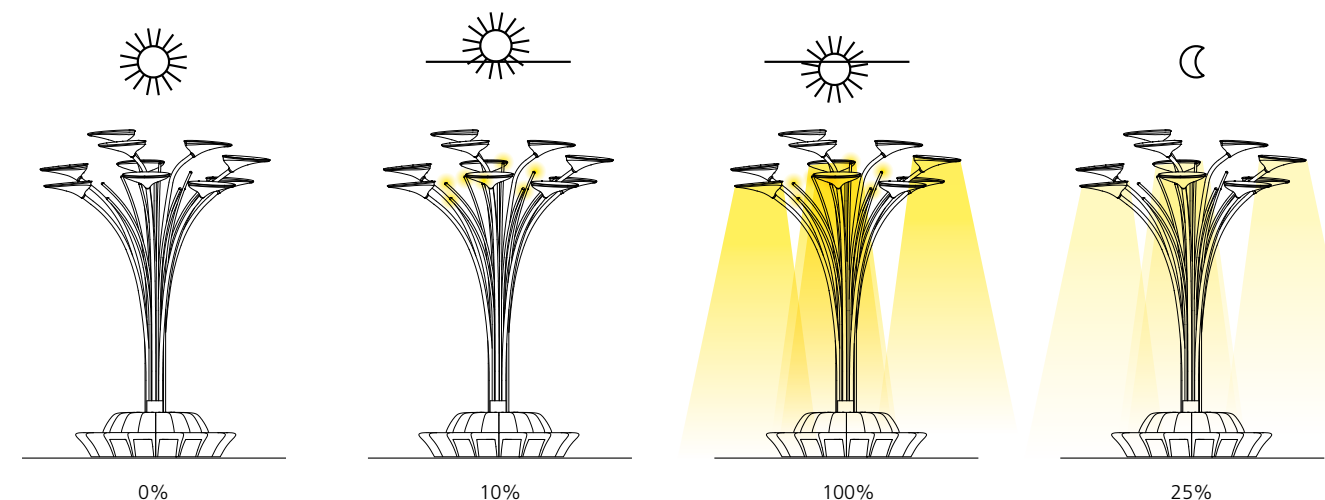

## WORKING

Solar Tree was designed for operation in the HYBRID configuration: in addition to the batteries, generally of the appropriate capacity to contain energy for autonomous operation for up to 7-10 days (with an energy-saving operation cycle, better specified below) with full charge, connection with the mains is provided for energy supply to the appliances (via an appropriate DC power unit connected with the mains) when the batteries are depleted. This is to ensure full service availability even in case of persistent bad weather and/or reduced sun irradiation or 100% use of the luminous performance of the appliance, or anyway when the energy balance is negative.

At dusk (recognized by determination of the dawn and sunset time entered into the calculation routine of the management programme or otherwise), the LED sources are turned on until dawn according to the pre-set duty-cycle.

In "HYBRID" appliances, the system draws energy from the batteries until these fall to the lower charge limit, then switches automatically to the mains.

For appliances based on this configuration, if mains connections coincided with the desired switching time of the public lighting appliances to which the Solar Tree functionally refers, appropriate settings would ensure that the voltage available upon powering is interpreted as a start signal for the Solar Tree and vice versa in case of disconnection from the mains.

## WORKING PROGRAMS

Two operating modes are available to satisfy individual needs – Manual and Automatic. The Automatic mode can, in turn, be configured in three different ways, according to the desired performance and energy saving attitude. More specifically: AUTO ECO: 100% operation at times of maximum attendance of the venue, limited operation of the LED heads only in the middle of the night (to ensure average 8 lux ground illumination, the LED sources are turned on and adjusted to approximately 25% of their nominal operating power from sunset to dawn. This mode is recommended to tend to full operation coverage even during the fall/winter in view of energy balance).

**AUTO 100%:** an operation mode that tends to ensure maximum operating performance of the appliance adjusting to the increased input of solar energy (if any).

**CUSTOMIZED:** the user can select the desired operating times and profiles.

The above-described profiles can be associated with deadlines and, therefore, be selected alternatively.

**MANUAL:** can be enabled by the user in case of special events and/or needs. The user can access the "fine" adjustment menu for selection on a 0-100% scale of the flow emitted by the individual LED heads and by the bunch of stems. The sources then remain switched on and adjusted according to the user's settings until switching off or returning to the automatic mode under the user's control.

# Solar Tree

## 2<sup>nd</sup> Generation

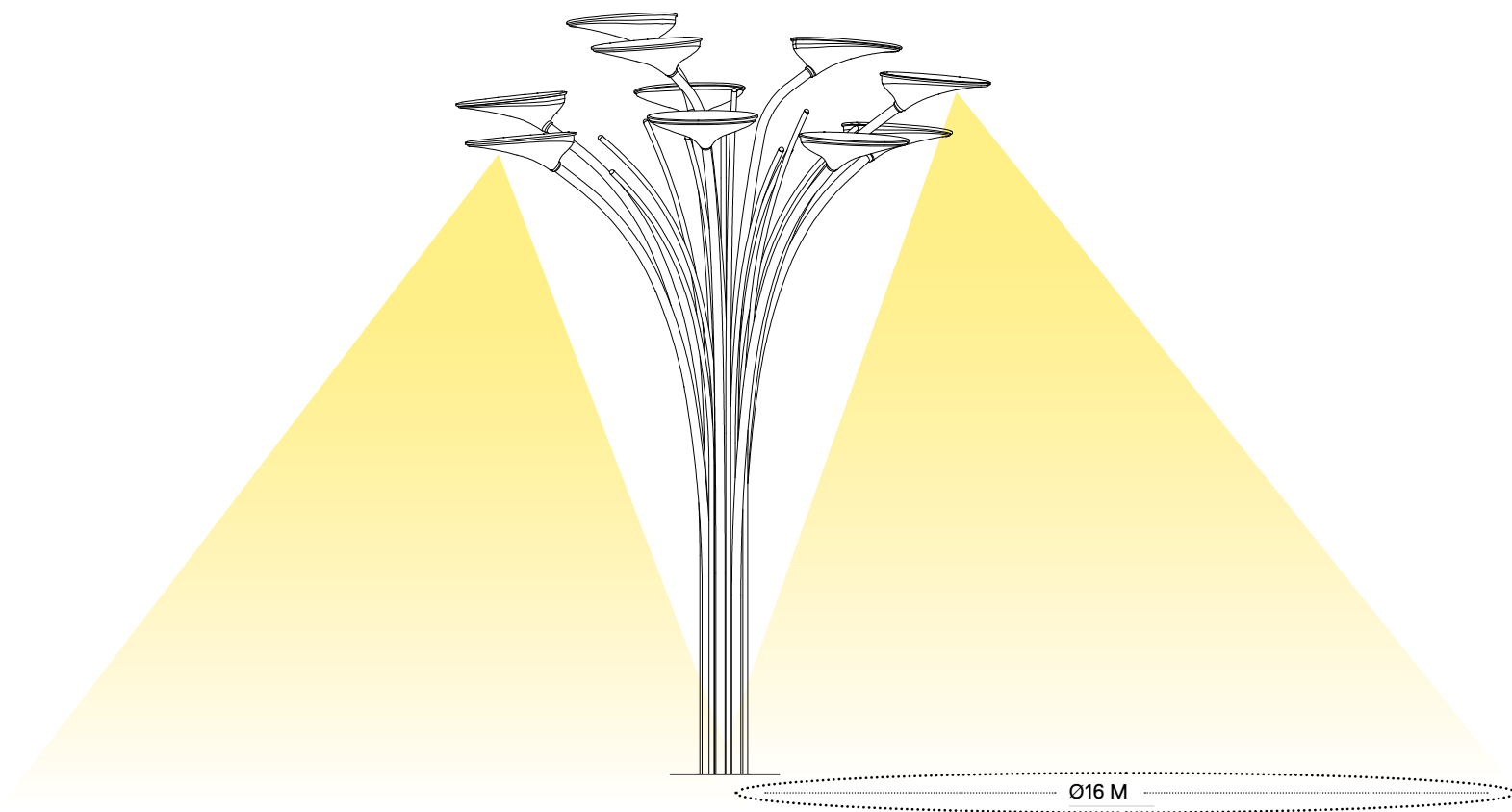

# new lighting performances

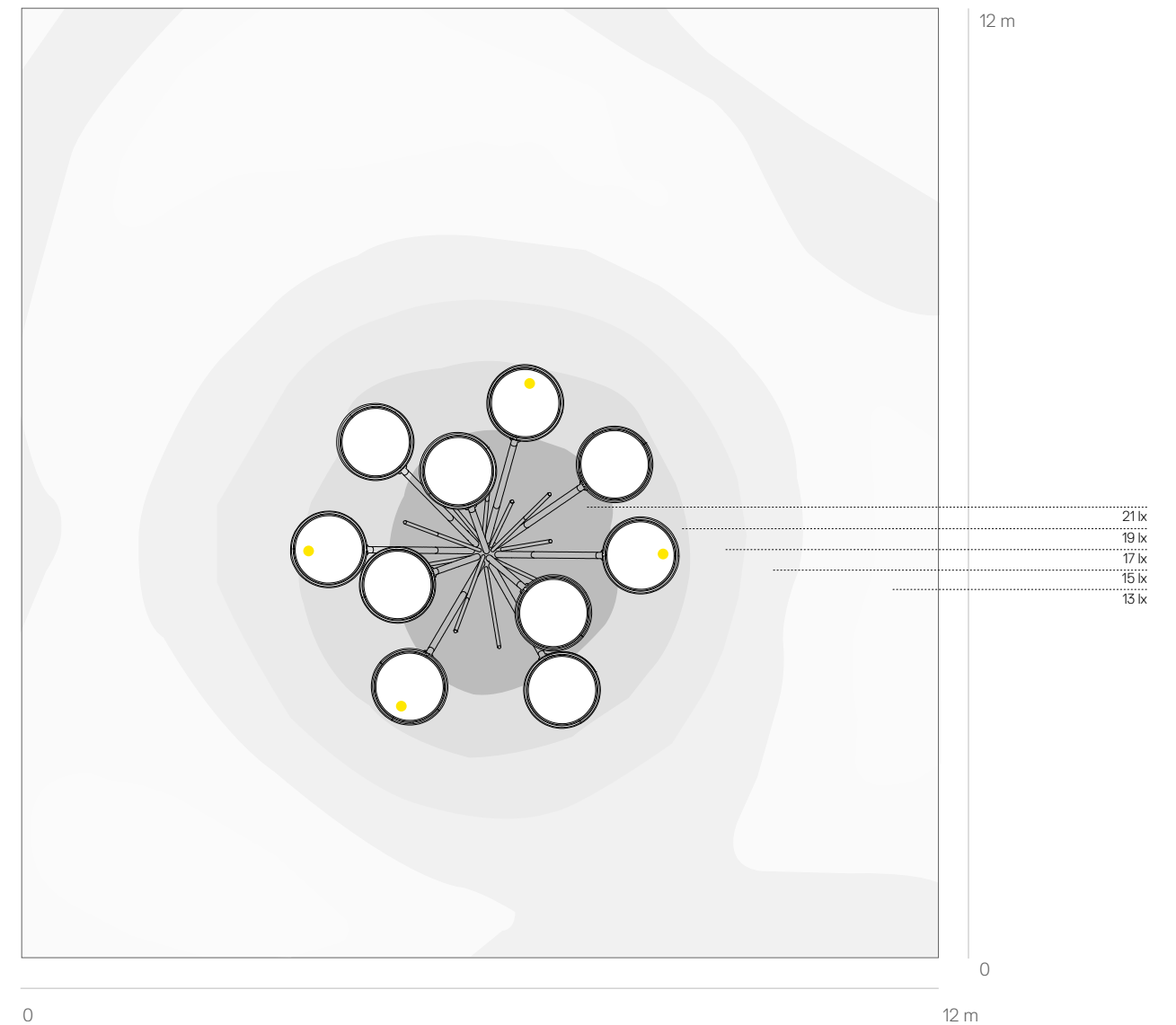

LUMINOUS PERFORMANCE: ASYMMETRIC EMISSION  
APPLIANCE'S PHOTO-BIOLOGICAL RISK: CLASS EXEMPT  
LIGHTING VALUE AT 32% OF THE MAXIMUM POWER: EM = 8 LUX ON AREA 12 X 12M

# Solar Tree 2<sup>nd</sup> Generation

# new intelligences and optionals

## NEW INTELLIGENCES

ETHERNET NETWORK  
USB ACCESS FOR DIAGNOSTICS /  
SETTING / SERVICE ACCESS /  
REMOTE ACCESS

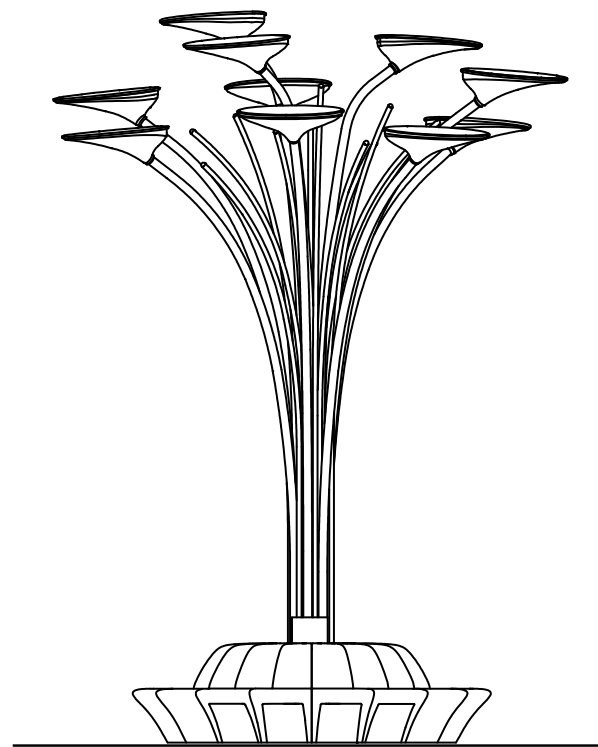

## OPTIONAL - PRESENCE SENSOR

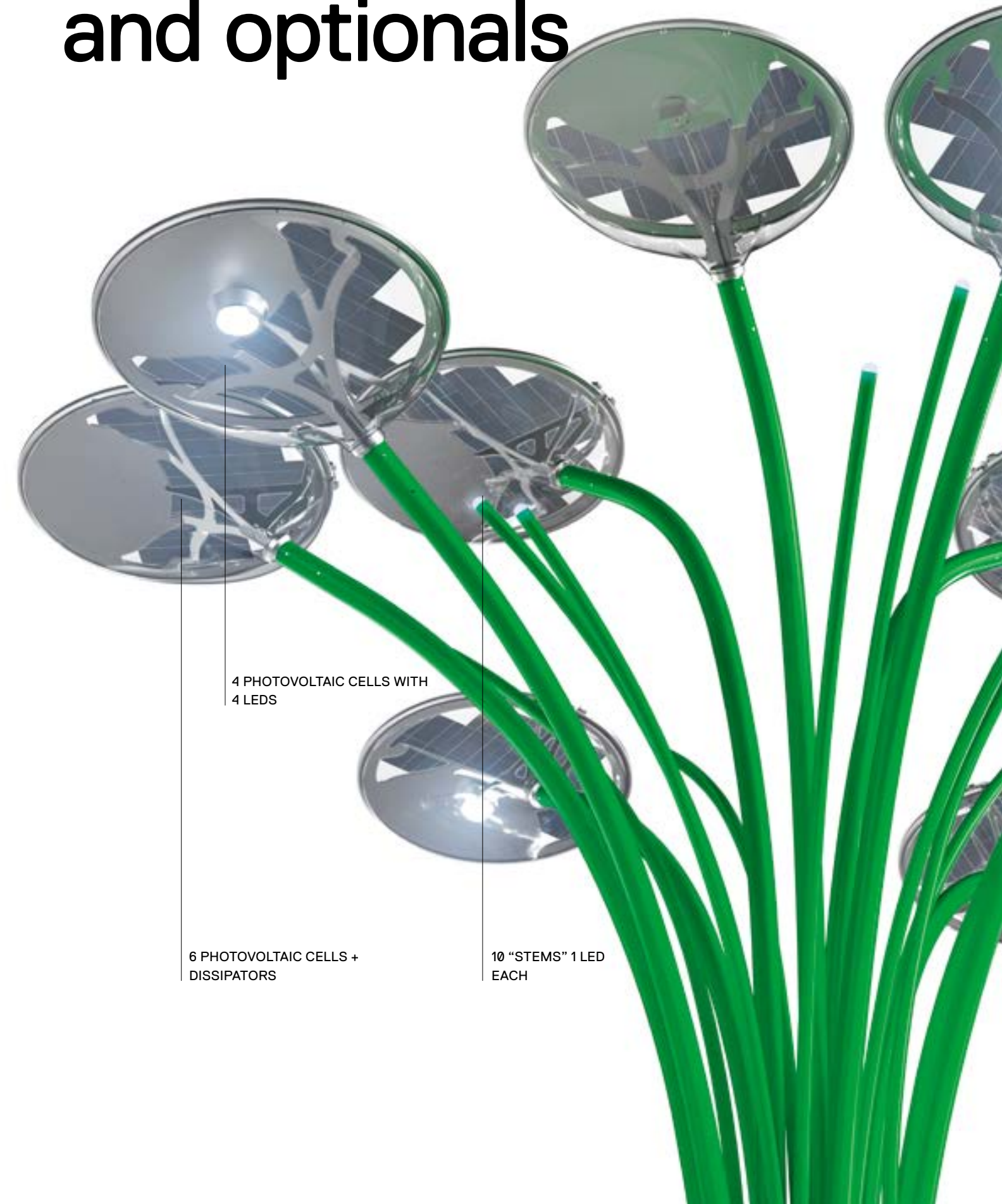
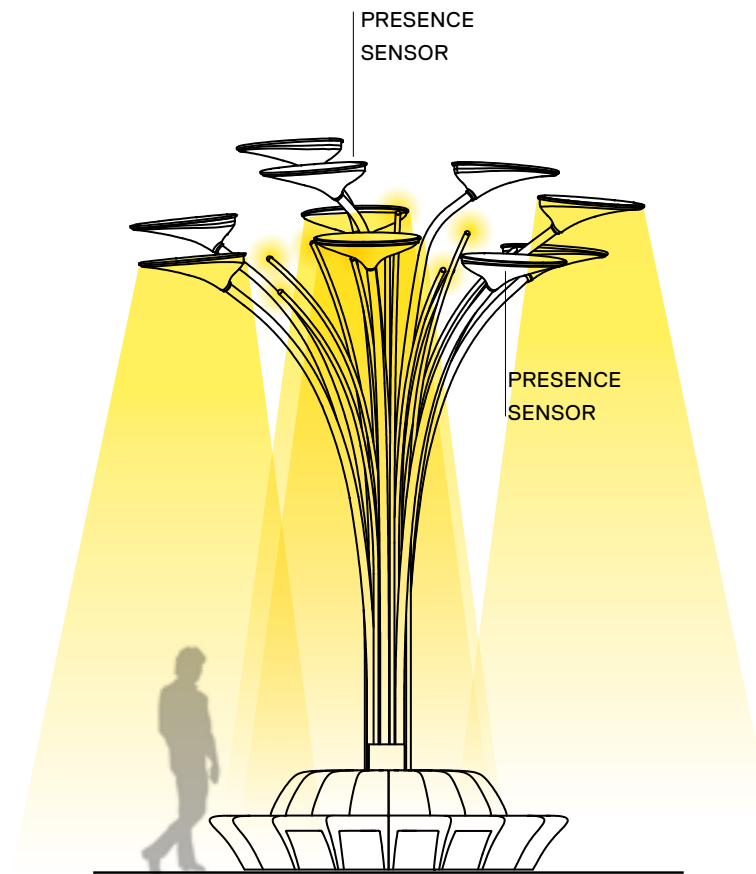

## ↳ SOLAR TREE 2<sup>ND</sup> GENERATION

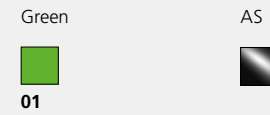

MacAdam 3SDCM IP65  
Life L70 (6K) 50000h  
CRI = 80

### SOLAR TREE 2<sup>ND</sup> GENERATION WITH BENCH

W	Flux	CCT	Code
4 heads LED29 W (116 W Tot.) + 10 stems LED 1,5 W (15 W Tot.)	2200 lm (8800 lm Tot.)	3000K	<b>AU00109</b>

10 heads with solar panels (4 with COB LED)  
10 LED "stems", batteries, structure with 18 benches  
Weight: 10.000 kg  
Wind resistance: 170 km/h

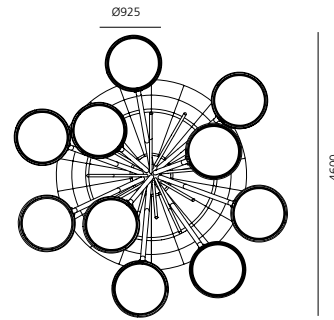

4600

Full services			
W	Flux	CCT	Code
4 heads LED29 W (116 W Tot.) + 10 stems LED 1,5 W (15 W Tot.)	2200 lm (8800 lm Tot.)	3000K	<b>AU00309</b>

10 heads with solar panels (4 with COB LED)  
10 LED "stems", batteries, structure with 18 benches  
Presence sensor, ethernet network  
usb access for diagnostics,  
setting, service access, remote access  
Weight: 10.000 kg  
Wind resistance: 170 km/h

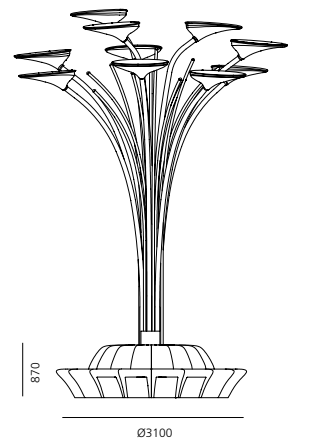

6350

IP65 power box and pole heads  
IP44 battery compartment  
IK10

## ↳ SOLAR TREE 2<sup>ND</sup> GENERATION

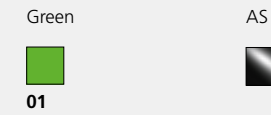

MacAdam 3SDCM IP65  
Life L70 (6K) 50000h  
CRI = 80

### SOLAR TREE 2<sup>ND</sup> GENERATION WITHOUT BENCH

10 Heads			
W	Flux	CCT	Code
4 heads LED29 W (116 W Tot.) + 10 stems LED 1,5 W (15 W Tot.)	2200 lm (8800 lm Tot.)	3000K	<b>AU00409</b>

10 heads with solar panels (4 with COB LED)  
10 LED "stems", batteries  
Plinth dimensioning to be defined in the project phase  
Wind resistance to be calculated in relation to the installation site

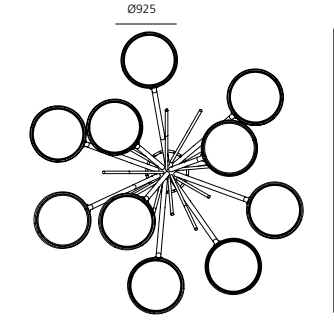

4600

10 Heads - Full services			
W	Flux	CCT	Code
4 heads LED29 W (116 W Tot.) + 10 stems LED 1,5 W (15 W Tot.)	2200 lm (8800 lm Tot.)	3000K	<b>AU00209</b>

10 heads with solar panels (4 with COB LED)  
10 LED "stems", batteries  
Plinth dimensioning to be defined in the project phase  
Wind resistance to be calculated in relation to the installation site  
Presence sensor, ethernet network  
usb access for diagnostics,  
setting, service access, remote access

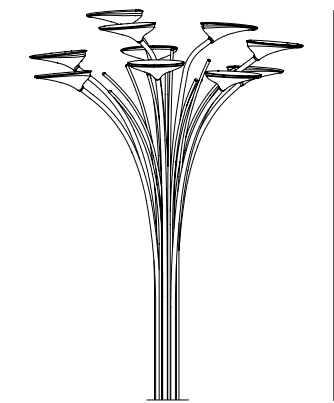

6350

IP65 power box and pole heads  
IP44 battery compartment  
IK10

4 Heads			
W	Flux	CCT	Code
4 heads LED29 W (116 W Tot.) + 10 stems LED 1,5 W (15 W Tot.)	2200 lm (8800 lm Tot.)	3000K	<b>AU00509</b>

4 heads with solar panels with 4 COB LED  
10 LED "stems", batteries  
Plinth dimensioning to be defined in the project phase  
Wind resistance to be calculated in relation to the installation site

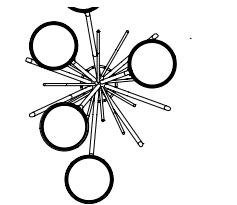

4600

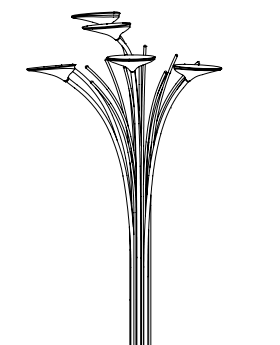

6350

IP65 power box and pole heads  
IP44 battery compartment  
IK10

# Solar Tree 2.0

Ross Lovegrove

↪ 2017

Solar Tree 2.0 has progressed to become a family of modular solutions. Two post heights are the structural features to use to put together various configurations to accommodate the needs of urban areas, with solutions that are not only functional but also interactive and energy-smart, to promote a new sustainable and social dimension for the city and for mankind.



For further information on Solar Tree 2.0  
↪ visit [artemide.com](http://artemide.com)





# Solar Tree 2.0

SOLAR TREE 2.0 - 380

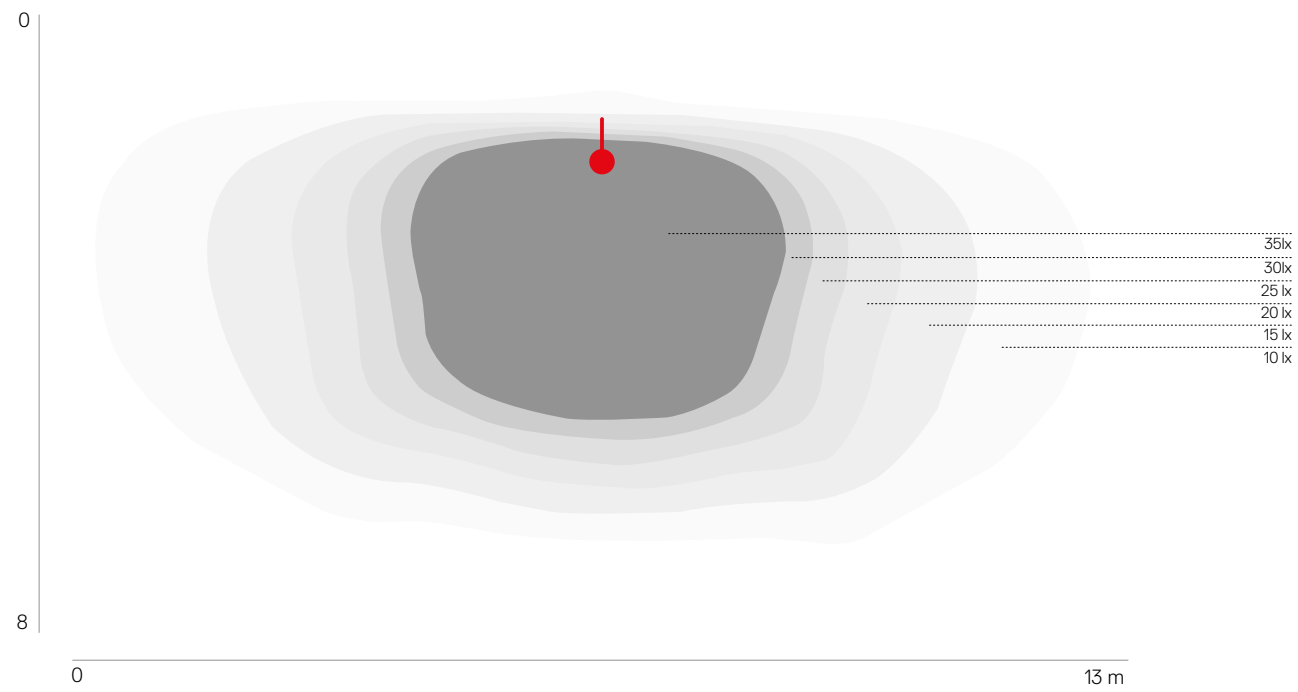

SOLAR TREE 2.0 - 500

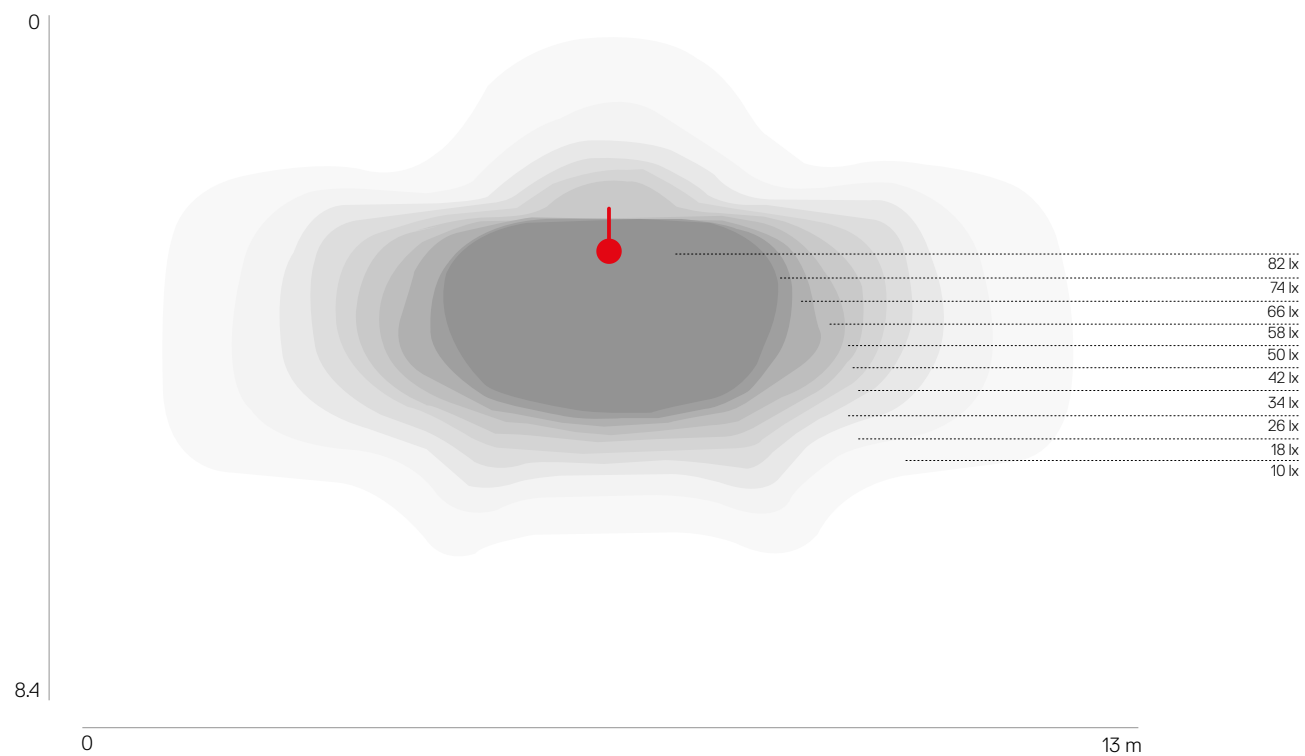

# Solar Tree 2.0

# a new family of poles

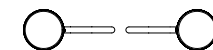
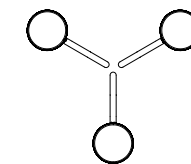
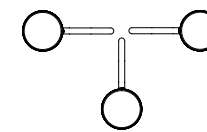
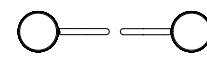
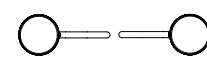
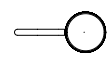
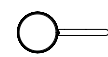

## SOLAR TREE 2.0 - 380

IDEAL FOR LIGHTING CYCLE PATHS,  
PEDESTRIANS AND HISTORIC CENTERS.  
DISTANCE BETWEEN POLES 14M

## SOLAR TREE 2.0 - 500

IDEAL FOR ROADS AND VEHICULAR PATH IN  
URBAN CENTERS.  
DISTANCE BETWEEN POLES 18M



↳ SOLAR TREE 2.0

Black



01

AS



MacAdam 3SDCM IP65  
 Life L70 (6K) 50000h  
 CRI = 90

SOLAR TREE 2.0 - 380

W	Weight	Beam	Flux	CCT	Code
35 W	37 kg	AS	2300 lm	4000K	<b>AU00304</b>

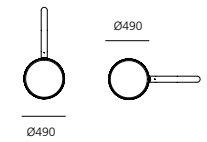
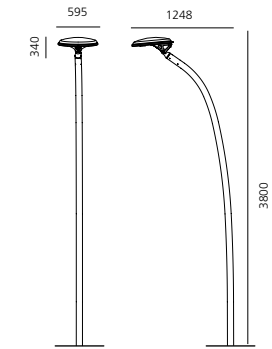

SOLAR TREE 2.0 - 500

W	Weight	Beam	Flux	CCT	Code
35 W	46 kg	AS	3200 lm	4000K	<b>AU00404</b>

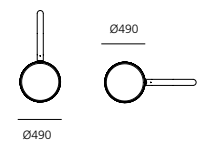
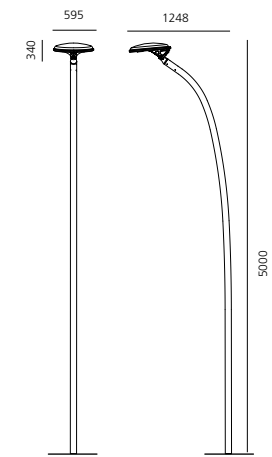

# Indicta

Ernesto Gismondi

↪ 2010

Danese Milano, Milan - (IT)

## ↪ INDICTA

Anthraxite Grey

AS

MacAdam 4SDCM  
Life L70 (6K)>35600h  
CRI = 80

IP65

W	Weight	Beam	Flux	CCT	Code
24 W	4,8 kg	AS	1433 lm 1341 lm	3000K 4000K	<b>T084810</b> <b>T084800</b>

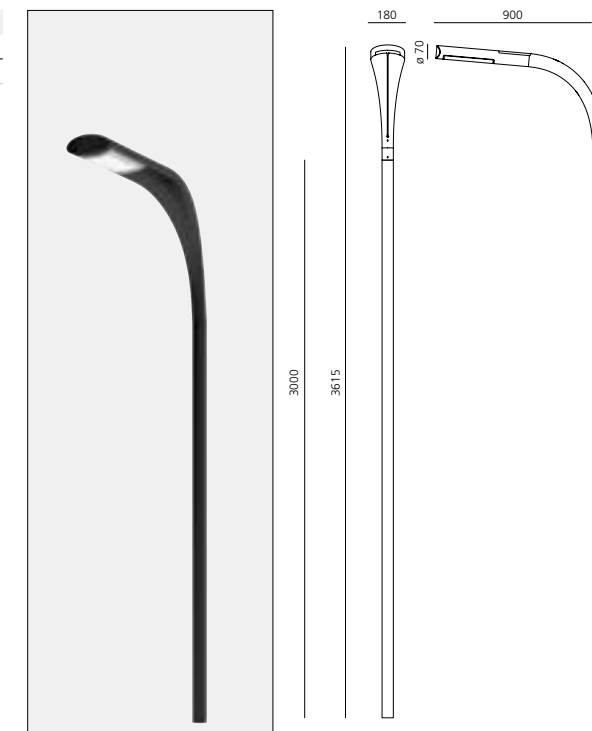
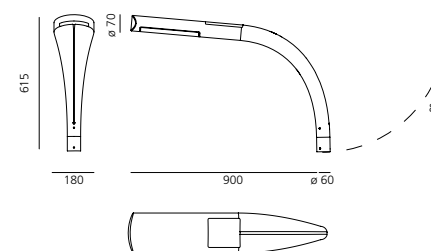

LED 23 W			Lighting application		
h	L	a	Em	Emax	Emin
3.5 m	4.0 m	13 m	12 lux	33 lux	2.8 lux

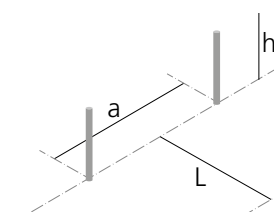

Light fixture with direct emission, with high-performance LED light sources.  
 ø60mm pole installation with ø35x110mm shank (not supplied).  
 Anthracite grey finish.  
 Consists of optical housing and support for pole installation.  
 Optical housing in extruded EN-AW-6060 aluminium, chromate treated and painted with 3-stage outdoor treatment: nanotechnologies, antioxidant primer, polyester paint.  
 UV resistant diffuser in shock resistant polycarbonate.

High-efficiency asymmetrical optics in metalised polycarbonate.  
 Optical housing support in high-resistance mass-coloured reinforced polymers.  
 AISI 316 stainless steel screws and silicone seal gaskets.  
 Provided with IP67 cable and connector for the mains connection.  
 Technical features of light fixtures in compliance with EN60598-1.  
 ENEC approved.



For further information on Indicta  
 ↪ visit [artemide.com](http://artemide.com)

# Poto

Ernesto Gismondi

↪ 2014

↪ POTO

White 00	Anthracite Grey 20	AS 	220/240Vac 50/60Hz electronic ballast included	MacAdam 2SDCM Life L70 (6K)>36300h CRI=80	IP65 IK10
-------------	-----------------------	---	--	---	--------------

W	Weight	Beam	Flux	CCT	Code
45 W	12,7 kg	AS	2586 lm	3000K	<b>T0826.</b> 00/20

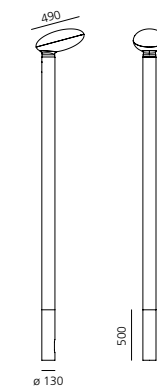

Pole appliance for direct lighting.

Consists of a pole head attached to the pole with grub screws.

The provided EN AW6060 aluminium pole should be bathed in concrete for 0.5m and rise 2.5m up from the ground.

The lighting body is fitted with an IP67 connector supporting cables with 5 to 13.5 mm diameters, to be fitted inside the pole.

The head has a transparent diffuser and a matt white top cap both in impact resistant PMMA. The body fitted inside the pole is made of EN AW6060 aluminium. Silicon seals.

Electronic power pack fitted inside the body suited for 4kV surges.

Internal reflector of metallised zamac fitted by sanded glass filter.

All the screws used for the outside of the product are made of AISI 316 INOX steel.

All the aluminium parts are finished with a 3-stage outdoor treatment: nanotechnologies, anti-oxidant primer, polyester paint.









For further information on Poto  
↪ visit [artemide.com](http://artemide.com)

# Sostituto Spot

Ernesto Gismondi  
↪ 2013



## ↪ SOSTITUTO SPOT

Anthracite Grey 	S F AS   	220/240Vac 50/60Hz electronic ballast included	MacAdam 4SDCM Life L70 (6K) = 51400h CRI = 80	IP65  IK10  80° 
--	---	--	---	--

W	Weight	Beam	Flux	CCT	Code
106 W	8,3 kg	S 9°	9183 lm	3000K	<b>T418410W00</b>
		F 24°	9276 lm	3000K	<b>T418423W00</b>
		AS	8795 lm	3000K	<b>T4184ELW00</b>

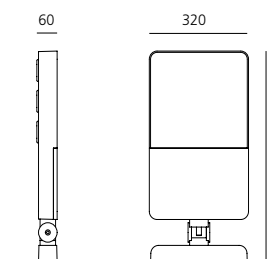

Light fixture with direct emission, with monochromatic LED light sources.

Floor, wall, eaves installation.

Consists of lighting unit composed by 3 interchangeable optical units, wiring terminal board and fixing plate. Positioning is maintained by means of locking dowels. Tilting with 5° adjustments. Positioning is ensured by means of fastening screws.

EN AB47100 aluminium body and terminal board, silicone gaskets. Electronic ballast integrated in the body.

Polycarbonate diffuser silicone-sealed to the lens supporting unit.

IP68 connector for the electrical connection to the mains, which can be located in the base compartment and is suitable for 5-13.5 mm diameter cables.

LED circuits with PMMA lenses in 3 beam versions: 9°, 24° and elliptical 12x40°.

All the screws used outside the product are in AISI 316 stainless steel.

All the components in die-cast aluminium are painted with 3-stage outdoor treatment: nanotechnologies, anti-oxidizing primer, polyester paint.

Technical features of the lighting fixtures in compliance with EN60598-1 and section 2-5.

Protection level from 4KV impulse overvoltage.



For further information on Sostituto Spot  
↪ visit [artemide.com](http://artemide.com)



### Spot optic

Concentrated luminous flow to highlight details avoiding unwanted light dispersion.



### Flood optic

Wide luminous flow suitable for lighting large areas.

# Sostituto Palo

Ernesto Gismondi

↪ 2013

Light fixture with direct emission, with monochromatic LED light sources.

Pole installation (pole not supplied).

The appliance is made up of a lighting body and a pole joint, adjustable with 5° angles up to 90° for use with horizontal terminal poles. Positioning is ensured by means of fastening screws.

Die-cast EN-AB 47100 aluminium lighting unit with 3-stage outdoor treatment: nanotechnologies, antioxidant primer, polyester paint.

Asymmetrical high-efficiency PMMA optical units. High-transparency shock-resistant polycarbonate screens. Consists of 3 interchangeable optical units.

Electronic ballast integrated in the body.

IP68 connector for connection with the mains inside the pole joint, accommodates cables with a 7-12 mm diameter.

AISI 316 fixing screws and silicone gaskets.

Suitable for ME3a and ME4a road lighting.

Technical features in compliance with EN60598-1-2-3.

Protection level from 4KV impulse overvoltage.

ENEC approved.



For further information on Sostituto Palo  
↪ visit [artemide.com](http://artemide.com)

## ↪ SOSTITUTO PALO

Anthracite Grey  
20

AS

220/240Vac 50/60Hz  
electronic ballast  
included

MacAdam 4SDCM  
Life L70 (9K)>51400 h  
CRI = 80

IP65  
IK10  
80°

### STANDARD

W	Weight	Beam	Flux	CCT	Code
106 W	8,5 kg	AS	7609 lm	4000K	T4183ELN00

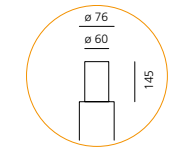

### HIGH FLUX

W	Weight	Beam	Flux	CCT	Code
106 W	8,5 kg	AS	11261 lm	4000K	T4183ELH00

CRI=70

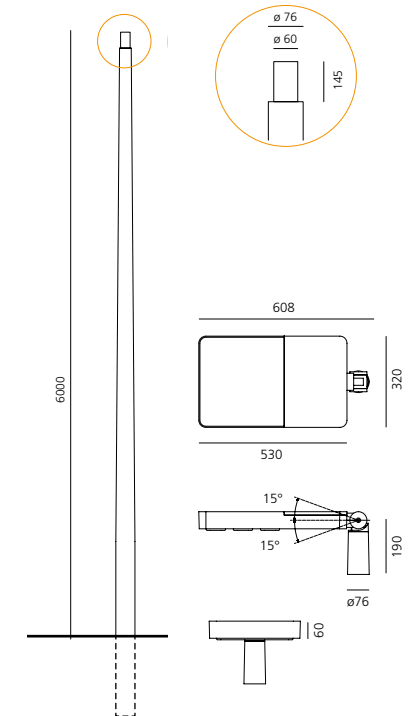

LED 105 W			Lighting application		
h	L	a	Em	Emax	Emin
6.0 m	6.0 m	24 m	23 lux	55 lux	13 lux

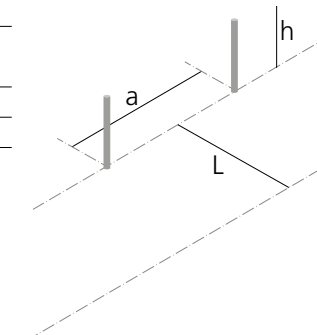



LAND ROVER

LAND ROVER

JAGUAR

BUY SALOON



# Cefiso

Alessandro Pedretti  
(Studio Rota & Partners)

↪ 2011

Light fixture with adjustable direct emission, with high-performance LED light sources.

Floor, wall and eaves installation.

2 sizes: Cefiso 14, Cefiso 20.

Available in two finishes: grey-white painted (RAL 9002) and anthracite grey painted.

Consists of adjustable lighting unit and terminal board. A graduated metal ring allows an accurate adjustment. Positioning is maintained by means of locking dowels.

Body and terminal board in EN AB44100 aluminium, silicone gaskets.

Electronic ballast integrated in the body.

Silkscreened tempered glass siliconed flush with the body to avoid backwater.

Wiring to be carried out inside the terminal board by piercing an IP65 grommet suitable for cables with a diameter of 8-13 mm.

PMMA lenses in 3 different versions of beams.

Screws in AISI 316 stainless steel.







Painted die-cast aluminium with 3-stage outdoor treatment: nanotechnologies, antioxidant primer, polyester paint.

Technical features of light fixtures in compliance with EN60598-1 and part 2-5.



For further information on Cefiso  
↪ visit [artemide.com](http://artemide.com)

↪ CEFISO

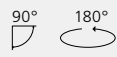
Grey-white Ral 9002  00	Anthracite Grey  10	XS 	WF 	WW 	220/240Vac 50/60Hz electronic ballast included	MacAdam 4SDCM Life L70 (6K)>39300h CRI =80	IP65  IK10 90° 180° 
---	---	---	---	---	--	--	---

CEFISO 14

W	Weight	Beam	Flux	CCT	Code
23 W	2,1 kg	XF 5,4°	1231 lm	3000K	<b>T418010W.00/10</b>
		WF 40°	1187 lm	3000K	<b>T418039W.00/10</b>
		WW	1198 lm	3000K	<b>T4180ELW.00/10</b>

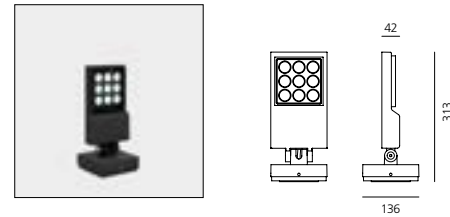

CEFISO 20

W	Weight	Beam	Flux	CCT	Code
38 W	4,4 kg	XF 5,4°	2188 lm	3000K	<b>T418110W.00/10</b>
		WF 40°	2110 lm	3000K	<b>T418139W.00/10</b>
		WW	2136 lm	3000K	<b>T4181ELW.00/10</b>

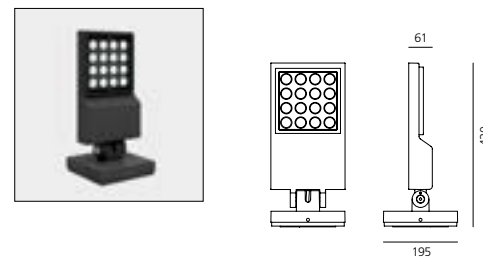

**Extra Spot optic**  
Concentrated luminous flow to highlight details avoiding unwanted light dispersion.



**Wide Flood optic**  
Wide luminous flow suitable for lighting large areas.



**Elliptical optic (WW)**  
Elliptical distribution of the luminous flow suitable for wall washer effect.





# Cefiso Palo

Alessandro Pedretti  
(Studio Rota & Partners)  
↪ 2011



Light fixture with adjustable direct emission, with high-performance LED light sources.

Pole installation.

Available in two finishes: light grey painted and anthracite grey painted.

Consists of lighting unit and pole support. Fixing is maintained by means of locking dowels.

The pole, not supplied, must have a  $\varnothing$  60 mm and h90 mm shank to correctly fix the head- pole. The pole height must be 4 m from the ground to provide a correct surface lighting. In this way, the poles can be installed at a distance of 15 m, suitable to light a 4 m carriageway in compliance with S3 class for cycle tracks.

Body in EN AB44100 aluminium, pole support in galvanized iron, silicone gaskets.

Electronic ballast integrated in the body.

The light fixture is protected from impulse overvoltage up to 4KV both in differential and common mode.

Silicone-sealed silk-screened tempered glass.

IP67 connector for electric connection to the mains, it can be housed in the pole compartment and is suitable for cables with a diameter of 5-13.5 mm.

LED circuits with PMMA lenses with road emission beam.

Screws in AISI 316 stainless steel.

All parts in die-cast aluminium and galvanised iron are painted with 3-stage outdoor treatment: nanotechnologies, antioxidant primer, polyester paint.

Technical features of light fixtures in compliance with EN60598-1.

## ↪ CEFISO PALO

Grey-white  
Ral 9002  
00

Anthracite  
Grey  
10

WW

220/240Vac 50/60Hz  
electronic ballast  
included

MacAdam 4SDCM  
Life L70 (6K)>39300h  
CRI = 80

IP65  
IK10

W	Weight	Beam	Flux	CCT	Code
41 W	2,1 kg	AS	1848 lm	3000K	T418200W.00/10

Code  
T418200W.00/10

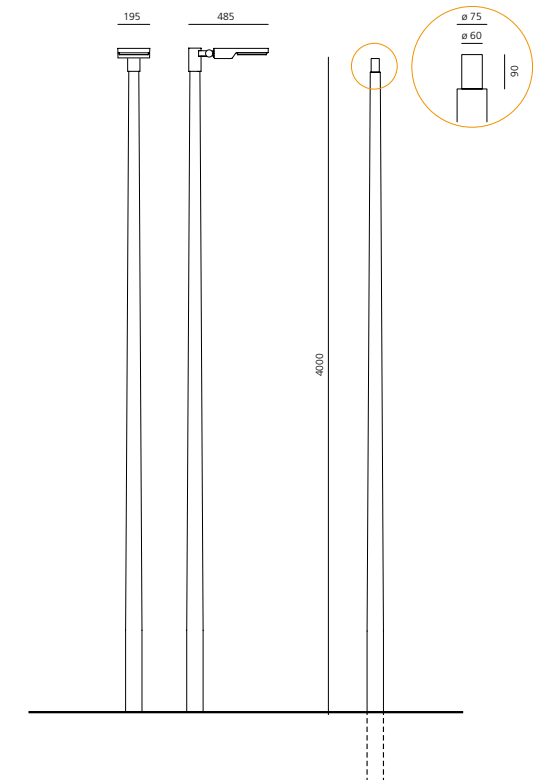
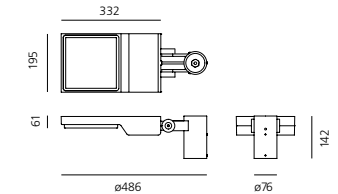

LED 40W			Lighting application		
h	L	a	Em	E <sub>max</sub>	E <sub>min</sub>
4.0 m	4.0 m	15 m	13 lux	27 lux	2.3 lux

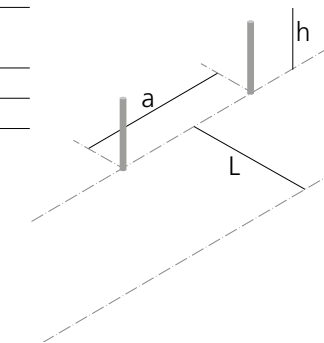

Suitable for street lighting in the class S3 (bike paths).



For further information on Cefiso Palo  
↪ visit [artemide.com](http://artemide.com)



# Cariddi

Ernesto Gismondi

↪ 2013

CARIDDI 30 / CARIDDI 40  
OPTICS 12°



CARIDDI 30  
OPTICS 16° - 35°

CARIDDI 40  
OPTICS 17° - 36°

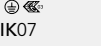

## ↪ CARIDDI

<p>Anthraxite Grey</p> 	<p>S F WF</p> 	<p>220/240Vac 50/60Hz electronic ballast included</p>	<p>MacAdam 2SDCM Life L70 (10K)&gt;36300h CRI = 80</p>	<p>IP65 IK07 130° 180°</p>  
--	---	---	--	---

### CARIDDI 30

W	Weight	Beam	Flux	CCT	Code
28 W	3,9 kg	S 12°	229 lm	3000K	<b>T418610W00</b>
		F 16°	1638 lm	3000K	<b>T418620W00</b>
		WF 35°	1468 lm	3000K	<b>T418640W00</b>

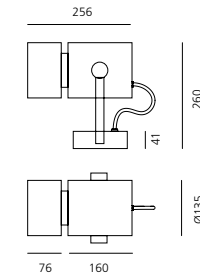

### CARIDDI 40

W	Weight	Beam	Flux	CCT	Code
41 W	3,9 kg	S 12°	356 lm	3000K	<b>T418710W00</b>
		F 17°	2322 lm	3000K	<b>T418720W00</b>
		WF 36°	2405 lm	3000K	<b>T418740W00</b>

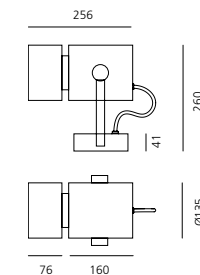

Floor, wall, ceiling, eaves installation.

Consists of an adjustable lighting unit and terminal board. Positioning is maintained by means of locking dowels.

The base and the lighting unit are connected by a H05RN-F 3x1 cable.

EN AB47100 aluminium head and terminal board, EN AW6060 aluminium body, silicone gaskets.

Electronic ballast integrated in the body.

Silicone-sealed silk-screened tempered glass.

Wiring to be performed inside the terminal board by piercing an IP65 grommet suitable for 8-12 mm diameter cables.

LED COB with PMMA lens and anodized aluminium reflector in 3 different beam versions.

The optical unit in the narrow-beam version is made up of a N-SF15 optical glass condensation lens and an external PMMA projection lens glued flush with the closing bezel of the lighting body.

Available in 2 different powers.

All the screws used outside the product are in AISI 316 stainless steel.

All the components in die-cast aluminium are painted with 3-stage outdoor treatment: nanotechnologies, anti-oxidizing primer, polyester paint.

Technical features of the light fixtures in compliance with EN60598-1 and section 2-5.



For further information on Cariddi  
↪ visit [artemide.com](http://artemide.com)



# Cariddi palo

Ernesto Gismondi

↪ 2014



## ↪ CARIDDI PALO

Anthracite  
Grey



AS



MacAdam 3SDCM  
Life L70 (6K) >36300h  
CRI = 80

IP65



IK07



90°

W	Weight	Beam	Flux	CCT	Code
24 W	3,9 kg	AS	1760 lm	3000K	<b>T419800W00</b>

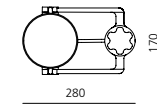
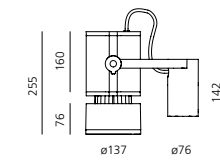

An adjustable direct lighting appliance that consists of a pole joint and an adjustable lighting body. Fixed into position with 6 grub screws.

The pole, not included, should have a 60mm spigot to allow appropriate fixing of the pole head. The pole should be 4m high to ensure appropriate surface illumination. Under these conditions, poles can be installed 15m apart to illuminate a 4m lane, in order to ensure compliance with class S3 for cycling lanes.

Cabling should be accommodated within the pole head, accessible through a lid, using an IP67 sealed connector fit for cables with 5 to 13.5mm diameters.

The lighting body is powered through a H05RN-F 2x1 cable.

Aluminium EN AB47100 head, pole joint, and sealing caps; aluminium EN AW6060 body and glass-holding ring, silicon gaskets. Electronic power unit inside the body.

Suited for public use, protected for 4kV surges, both in the common and in the differential mode.

Moulded silicon road lighting appliance. The tempered glass diffuser glued flush to the lighting body ensures the absence of lighting pollution.

INOX AISI 316 steel screws.

Die-cast aluminium elements painted with 3-stage outdoor treatment: nanotechnologies, anti-oxidizing primer, polyester paint.

The technical features of the appliances comply with the EN60598-2-3 norm.



For further information on Cariddi Palo  
↪ visit [artemide.com](http://artemide.com)





↪ **Technical**

The carefulness of Artemide for new technologies and for the improvement of its products implies a continuous updating of technical information.

For in-depth and detailed products specifications, Artemide recommends to refer to the website and Artemide Cloud platform, tools that are constantly updated.

[www.artemide.com](http://www.artemide.com)  
[cloud.artemide.com](http://cloud.artemide.com)

PRODUCT GENERAL INFORMATION

↪ A.24 SOSPENSIONE - EMISSIONE SHARPING

White 01 Fast delivery	Black 04	Brushed Silver 15	Brushed Copper 18	Brushed Bronze 20	F	XF	*Uses 1 DALI address ** Uses 2 DALI addresses *** Uses 3 DALI addresses	MacAdam 2SDCM Life L90 (20K) 118000h CRI = 90	IP20
------------------------------	-------------	----------------------	----------------------	----------------------	---	----	---	---	------

Modulo lineare - emissione diretta					Code
Length	W	Beam	Flux	CCT	
1176 mm*	22W	F 24°	1528 lm	2700K	<b>AQ424.</b> 01/04 15/18/20
			1628 lm	3000K	<b>AQ420.</b> 01/04 15/18/20
			1742 lm	4000K	<b>AQ421.</b> 01/04 15/18/20
		XF 62°	1624 lm	2700K	<b>AQ444.</b> 01/04 15/18/20
			1731 lm	3000K	<b>AQ440.</b> 01/04 15/18/20
			1852 lm	4000K	<b>AQ441.</b> 01/04 15/18/20
2352 mm**	46W	F 24°	3056 lm	2700K	<b>AQ425.</b> 01/04 15/18/20
			3256 lm	3000K	<b>AQ422.</b> 01/04 15/18/20
			3485 lm	4000K	<b>AQ423.</b> 01/04 15/18/20
		XF 62°	3249 lm	2700K	<b>AQ445.</b> 01/04 15/18/20
			3461 lm	3000K	<b>AQ442.</b> 01/04 15/18/20
			3704 lm	4000K	<b>AQ443.</b> 01/04 15/18/20

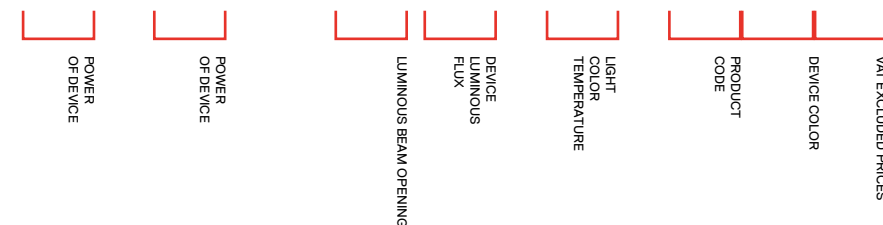

CLASSIFICATIONS

Class I  
 Device in which electrical safety is provided by an additional protective conductor (earth) connected to the metal frame of the lamp.

Class II  
 Device in which protection against electric shocks is not provided solely by the basic insulation, but which has additional safety measures such as double or reinforced insulation. These measures do not involve earthing devices and do not depend on the installation conditions.

Class III  
 Device in which protection against electric shocks is based on a safety extra-low voltage power source and in which no voltages greater than this can be generated. A class III device does not need earth protection.

RATES

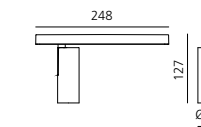

The diagrams shown in this catalogue are expressed in millimetres.

IP DEGREE OF PROTECTION

Electrical fittings are designed to prevent the intrusion and contact of solids and liquids with live parts. Resistance to the penetration of solids and liquids is expressed by the acronym IP, followed by two digits that show the degree of protection: the first digit refers to solid bodies, the second to liquids.

- First digit
- 0 No protection.
  - 1 Protected against the penetration of solid bodies larger than 50 mm.
  - 2 Protected against the penetration of solid bodies larger than 12 mm.
  - 3 Protected against the penetration of solid bodies larger than 2.5 mm.
  - 4 Protected against the penetration of solid bodies larger than 1 mm.
  - 5 Protected against dust.
  - 6 Totally dust-tight.

APPROVALS

ENEC certification of European conformity.

DALI

Each DALI device occupies one address, unless otherwise specified.

DRIVER

One driver powers one device, unless otherwise specified.

ARTEMIDE APP

When a product managed by Artemide App is installed, the application takes priority on the DALI dimming.

- Second digit
- 0 No protection.
  - 1 Protected against dripping water.
  - 2 Protected against dripping water up to 15° from the vertical.
  - 3 Protected against rain.
  - 4 Protected against splashing water.
  - 5 Protected against water jets.
  - 6 Protected against waves.
  - 7 Water-tight on immersion.
  - 8 Water-tight on submersion.

## ↪ CHARACTERISTICS OF LED AND COMPONENTS

Artemide always develops its products with special attention to the flexibility of using all possible innovations in the field of LEDs. Many are, in fact, a variety of components available on the market, each with its own special features and suitable for different purposes.

Artemide designs and manufactures all the LED circuits required to turn on the product and operate it correctly over time, in order to prevent any problems and quickly repair any possible defects.

Among the most important types of LED used are:

- 5mm LED, which offers the highest average life span with intermediate light levels;
- SMD-LED, which enables the size to be minimised while maintaining good values of luminous flux;
- Power LED, characterised by a wide choice of power and luminous flux and high life expectancy;
- multi-chip LED, characterised by high power, up to over 20W per module, with high luminous flux.

Artemide offers the possibility of using dimmable systems (1-10V, PUSH button, DALI) or home automation control and lighting management systems by means of specific drivers or ad-hoc solutions. The dimming of the LED allows you to create user-controlled lighting scenarios and adjust the brightness for better viewing comfort.

Artemide is able to customise and tailor their products to meet the various design requirements, thanks to the electronic control and the flexibility in the choice of LED. To request any type of specific or special project, you can contact our technical department.

Artemide manufactures its circuits with power signals in constant current or constant voltage, equivalent to a connection in series or in parallel to the products, respectively. For the correct selection of the transformer or power supply required to operate the lighting, we recommend you follow these guidelines:

Power calculation for electronic driver with constant current:  
To properly select the driver necessary for electrical installation, it is sufficient to sum up the power values of each fixture, expressed in W (Watt), as indicated in the catalogue, and to select a ballast with a rated power 20% higher than the resulting total power value.

7 x Linea LED 8W - 24Vdc  
7 x 8W = 56W + 20% = 67,2W -> Power supply T409999

Power calculation for electronic driver with constant current  
To properly select the driver with constant current (350/500/700mA), choose the driver following the indication "N° LED max" in the relevant driver table.

3 x Zeno Up 3 - 500mA  
3 x 3 = 9 LED x 2W -> Power supply NL19034

## ↪ DRIVERS

### Constant current driver for series connection (indoor use)

Code	Description	V (Vac)	I (mA)	P (W)	N°Led max*	L (mm)	W (mm)	H (mm)	
NL19041	Driver 8W 500mA SLIM	220-240	500	8	4	22	110	19	indip. use
NL19036	Driver 20W 700mA	220-240	700	20	2-7	125	38	23	indip. use

### Constant current driver for series connection (outdoor use)

Code	Description	V (Vac)	I (mA)	P (W)	N°Led max*	L (mm)	W (mm)	H (mm)	IP Rate
DV3001	Driver 14W 350mA	220-240	350	14 W	1-10	79	38	25	IP 67
DV3002	Driver 14W 500mA	220-240	500	14 W	1-7	79	38	25	IP 67
DV3003	Driver 14W 700mA	220-240	700	14 W	1-5	79	38	25	IP 67
DV3004	Driver 30W 700mA	220-240	700	30 W	7-10	120	38	25	IP 67
DV1042	Driver 23-55W 350-1000mA	220-240	350/500/700	23/27/38W	3-12	185	35	33	IP 67

### Constant-power ballasts with plastic wrapper for parallel connection

Code	Description	V <sub>in</sub> (Vac)	V <sub>out</sub> (Vac)	P (VA)	L (mm)	W (mm)	H (mm)	IP Rate
T409996	Driver 25W 24Vdc	100-277	24	25	150	40	32	IP 67
T409998	Driver 60W 24Vdc	100-277	24	60	165	43	32	IP 67
T409999	Driver 90W 24Vdc	100-277	24	90	165	61	36	IP 67
DV5004	Driver 150W 24Vdc	100-277	24	150	228	68	39	IP 67
DV1041	Driver 24W 24Vdc	220-240	24	24	185	35	33	IP 67
DV1043	Driver 150W 12Vdc	100-277	12	150	228	68	39	IP 67

## ↪ DRIVERS

### SPECIFICATIONS FOR NAIAD 55 AND NAIAD 90 POWER SUPPLY

Number of fixtures which can be installed according to: Power, Cable section, Line length

#### Ego 55

Code	Power	Line length	Cable 1,5 mm <sup>2</sup>	Cable 2,5 mm <sup>2</sup>	Cable 4 mm <sup>2</sup>
T409996	25W 24Vdc	10 m	13	13	13
	25W 24Vdc	50 m	13	13	13
	25W 24Vdc	100 m	13	13	13
	25W 24Vdc	150 m	12	12	13
	25W 24Vdc	200 m	11	12	13

#### T409998

60W 24Vdc	10 m	33	33	33
60W 24Vdc	50 m	31	32	33
60W 24Vdc	100 m	27	30	31
60W 24Vdc	150 m	23	27	30
60W 24Vdc	200 m	19	25	29

#### T409999

90W 24Vdc	10 m	49	50	50
90W 24Vdc	50 m	43	46	48
90W 24Vdc	100 m	35	42	46
90W 24Vdc	150 m	26	37	42
90W 24Vdc	200 m	19	31	39

#### Ego 90

Code	Power	Line length	Cable 1,5 mm <sup>2</sup>	Cable 2,5 mm <sup>2</sup>	Cable 4 mm <sup>2</sup>
T409996	25W 24Vdc	10 m	5	5	5
	25W 24Vdc	50 m	5	5	5
	25W 24Vdc	100 m	4	5	5
	25W 24Vdc	150 m	4	4	5
	25W 24Vdc	200 m	4	4	4

#### T409998

60W 24Vdc	10 m	12	12	12
60W 24Vdc	50 m	12	12	12
60W 24Vdc	100 m	10	11	12
60W 24Vdc	150 m	8	10	11
60W 24Vdc	200 m	7	9	11

#### T409999

90W 24Vdc	10 m	18	18	18
90W 24Vdc	50 m	16	17	18
90W 24Vdc	100 m	13	16	17
90W 24Vdc	150 m	9	14	16
90W 24Vdc	200 m	7	12	15

### SPECIFICATIONS FOR REEDS IP68 AND REEDS IP68 TRIPLE POWER SUPPLY

Number of fixtures which can be installed according to: Power, Cable section, Line length

#### Reeds IP68

Code	Power	Line length	Cable 1,5 mm <sup>2</sup>	Cable 2,5 mm <sup>2</sup>	Cable 4 mm <sup>2</sup>
T409996	25W 24Vdc	10 m	2	2	2
	25W 24Vdc	50 m	2	2	2
	25W 24Vdc	100 m	2	2	2
	25W 24Vdc	150 m	2	2	2
	25W 24Vdc	200 m	1	2	2

#### T409998

60W 24Vdc	10 m	5	5	6
60W 24Vdc	50 m	5	5	5
60W 24Vdc	100 m	4	4	5
60W 24Vdc	150 m	3	4	4
60W 24Vdc	200 m	2	3	4

#### T409999

90W 24Vdc	10 m	8	8	8
90W 24Vdc	50 m	7	7	8
90W 24Vdc	100 m	5	6	7
90W 24Vdc	150 m	3	5	6
90W 24Vdc	200 m	2	4	5

#### Reeds IP68 triple

Code	Power	Line length	Cable 1,5 mm <sup>2</sup>	Cable 2,5 mm <sup>2</sup>	Cable 4 mm <sup>2</sup>
T409998	60W 24Vdc	10 m	1	1	2
	60W 24Vdc	50 m	1	1	1
	60W 24Vdc	100 m	1	1	1
	60W 24Vdc	150 m	1	1	1
	60W 24Vdc	200 m	-	1	1

#### T409999

90W 24Vdc	10 m	2	2	2
90W 24Vdc	50 m	2	2	2
90W 24Vdc	100 m	1	2	2
90W 24Vdc	150 m	1	1	2
90W 24Vdc	200 m	-	1	2

Max surge supported by the ballasts: 2kV.

Working temperature of the ballasts: -35°C + 50°C.

The ballasts must not be directly exposed to UV-rays.

When calculating sections/lengths, all the fixtures should supplied with power at the line end.

The IP67 connector supplied with the fixtures is suitable for sections from 1.5 to 4 mm<sup>2</sup>.

Insulation class II. Earthing is not required.

## ↪ CONSTANT CURRENT REGULATORS



### DIMMABLE CONSTANT CURRENT REGULATORS FOR INDOOR USE

Code	Description	V (Vac)	I (mA)	N°Led max	L (mm)	W (mm)	H (mm)
NL11103	Constant current regulator 350mA	12	350	1-3	19	57	16
		24	350	1-6	19	57	16
NL11107	Constant current regulator 500mA	12	500	1-3	19	57	16
		24	500	1-6	19	57	16
NL11108	Constant current regulator 700mA	12	700	1-2	19	57	16
		24	700	1-5	19	57	16

### DIMMABLE CONSTANT CURRENT REGULATORS FOR OUTDOOR USE

Code	Description	V (Vac)	I (mA)	N°Led max	L (mm)	Ø (mm)	IP Rate
NL11106	Constant current regulator 350mA IP67	12	350	1-3	130	32	IP 67
		24	350	1-6	130	32	IP 67
NL11104	Constant current regulator 500mA IP67	12	500	1-3	130	32	IP 67
		24	500	1-6	130	32	IP 67
NL11102	Constant current regulator 700mA IP67	12	700	1-2	130	32	IP 67
		24	700	1-5	130	32	IP 67

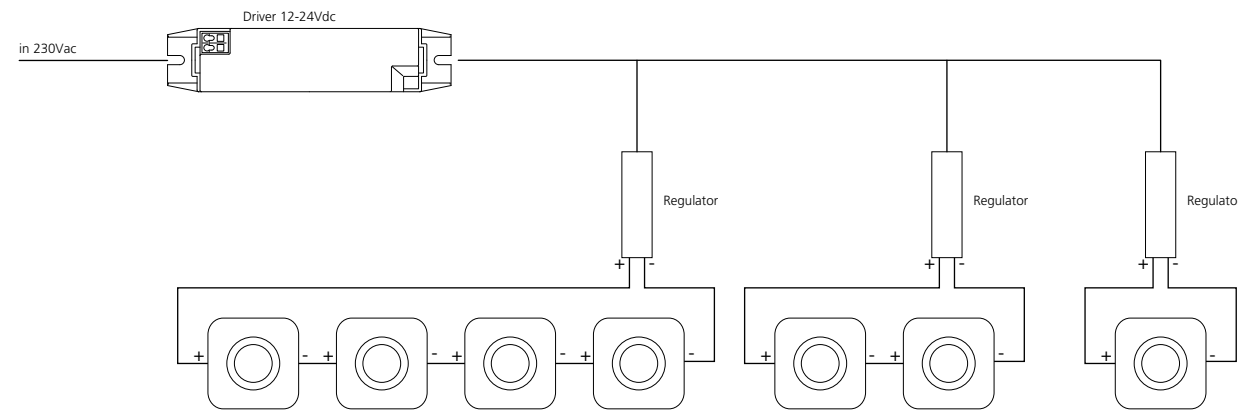

## ↪ RGB CONTROL SYSTEMS

### WIRING DIAGRAM FOR RGB LED SYSTEMS RGB

Artemide Drivers and controller allow a flexible and fully programmable dynamic lighting System. The LED Drivers are compatible with the USITT DMX 512 Standard which is a simple, reliable and economic light management and can be easily interfaced with modern domotic Systems. The DMX data lines are electrically opto-isolated to ensure the maximal reliability and to avoid disturbances.

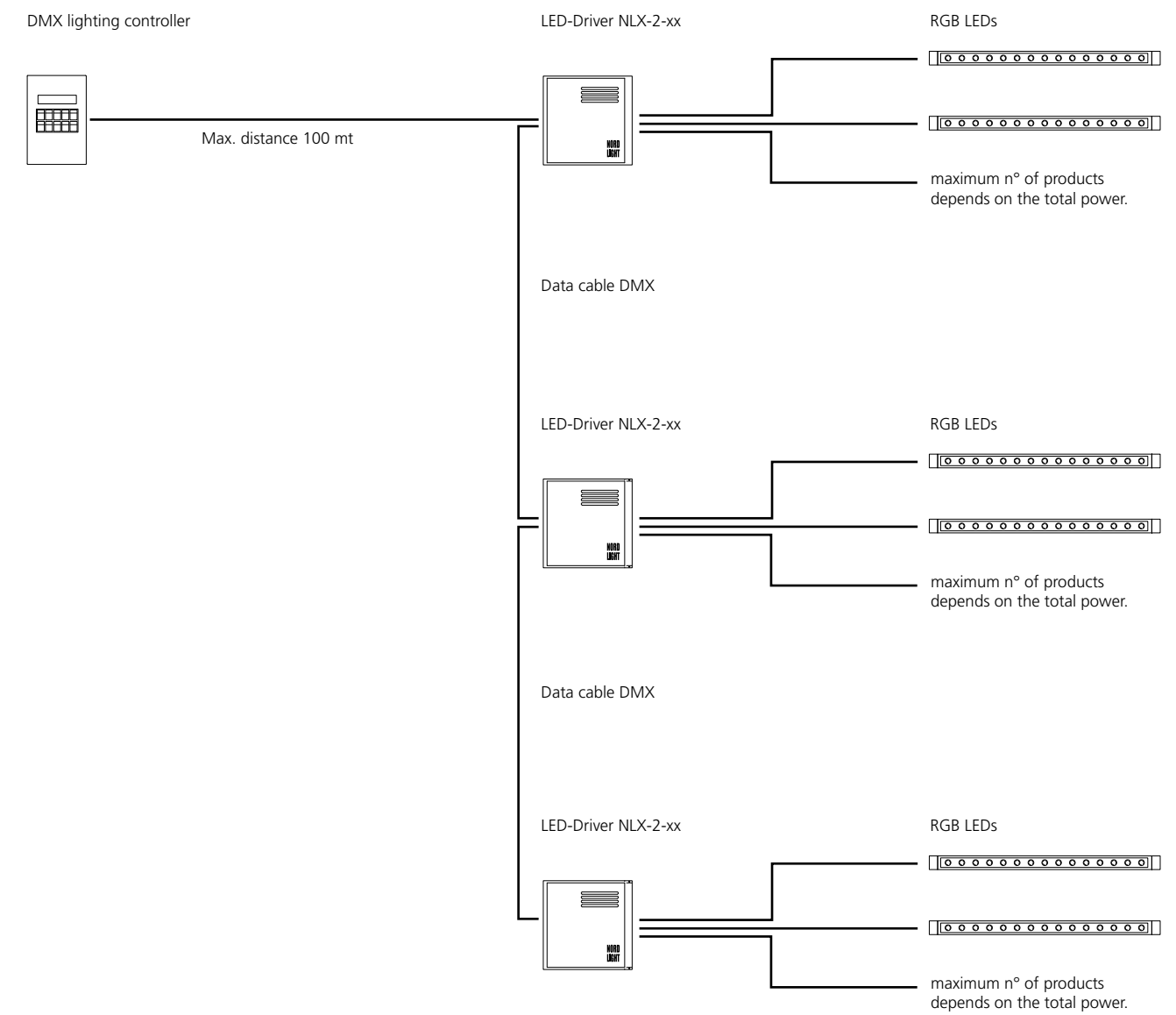

## CONTROLLERS DMX

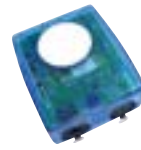

NL19030 DSC30 USB interface - DMX stand alone							
Data In	Data Out	DMX ch.	Scenes	Driver	Data cable	L x W x H (mm)	Weight (kg)
USB	DMX	2x512 stand alone	255	5-5,5Vdc - 300mA excl.	DMX 2m/XLR + USB	80x40x90	0,7
USB	DMX	2x512 live	255	5-5,5Vdc - 300mA excl.	DMX 2m/XLR + USB	80x40x90	0,7

**NL19031** 5Vdc 300mA plug-in power supply Mini-USB  
**NL7833** 50cm cable with HE10 connector for keyboard (optional)

Standard USB-DMX "Stand Alone" interface (512 channels, real-time clock, Local use), software, USB cable. Live mode with a computer; Stand Alone mode. Scenes can be triggered in sequential or using external push-buttons to trigger for instance 8 Scenes. Upon request: connection to external keyboard or to domotics Systems. Needs an external power supply for the Stand Alone mode. Upon request: connection to external keyboard or to domotics Systems.

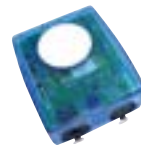

NL19081 DSC60 USB/Ethernet Interface							
Data In	Data Out	DMX ch.	Scenes	Driver	Data cable	L x W x H (mm)	Weight (kg)
Ethernet	DMX	2x512	250	5-5,5Vdc - 300mA excl.	DMX 2m/XLR + Ethernet	80x40x90	0,7

**NL19031** 5Vdc 300mA plug-in power supply Mini-USB

Standard USB and Ethernet DMX "Stand Alone" Interface (2x512 channels), with software, USB cable, 3 DMX 512 universes in live mode with a computer (not included); 2 DMX512 universes in stand-alone mode. Micro sd-card memory for stand-alone use, 8 dry contact trigger ports via HE10 connector (upon request). Clock & calendar function. Stand-alone mode with 5 areas and 250 scenes. WIFI remote control option with smart phone/tablet (IOS, ANDROID, Windows, Linux) to trigger scene. Simply connect to your wireless local network, the WIFI remote control app will automatically find the interface and allow you to control it. A second application, compatible with any IOS and ANDROID smart phones or tablets, allows you to easily create or change the lighting surroundings in each area. In just a few steps, you'll be able to take control of all your DMX fixtures in live, or Stand Alone mode. The simple application can be used by just about everyone in any situation. The interface needs an external power supply for the Stand Alone mode.



NL19080 DSC70 USB Glass Touch Sensitive Control Keypad							
Data In	Data Out	DMX ch.	Scenes	Driver	Data cable	L x W x H (mm)	Weight (kg)
USB	DMX	512	99	5-12Vdc - 300mA excl.	RJ45 + USB	110x86x10	0,2

**NL19083** 5Vdc 300mA plug-in power supply

Thanks to the "All-in-One" technology, the DSC70 includes a high-tech keypad, stand-alone memory storage and a powerful DMX512 lighting software package. It offers the best solution for projects requiring a large amount of scenes along with an uncluttered and intuitive interface. The computer programmable, flat wall mounted lighting controller is ideal for LED, RGB & DMX lighting and capable of playing up to 99 scenes, each of which can be modified by touching the mode button to change the dimmer and color. The LED display makes it easy to tell which scene number is playing. The panel allows it to be mounted on any single gang wall socket around the world. Large memory capacity, 4 touch sensitive buttons, glass wall-mounted DMX controller. Micro-USB for programming. For PC, Mac & Tablet with USB. 32bit RM technology, software included. Stand alone operation. Ready to use (pre-loaded). The interface needs an external power supply which can be placed in the gang wall socket.

## DRIVERS LED



### LED Driver NLX IP40

Code	Description	Contr.	P (W)	V <sub>in</sub>	V <sub>out</sub> (Vdc)	CH	L x W x H (mm)	Weight (kg)
NL75190	NLX 2-75	DMX	75	100-240 Vac	24	2xRGB	270x200x80	1,4
NL19084	NLX 1-75	DMX/RDM	72/144	12-24 Vdc	12-24	1xRGB(W)	153x50x23	0,2
NL12150	NLX 1-100	DMX/DALI	95	120-250 Vac	12/24	2xRGB(W)	388x42x30	0,7



### LED Driver NLX IP66

Code	Description	Contr.	P (W)	V <sub>in</sub>	V <sub>out</sub> (Vdc)	CH	L x W x H (mm)	Weight (kg)
DV1046	NLX 1-100IP	DMX/DALI	95	120-250	24	1xRGB	340x103x61	1,7

PWM Driver for LED units with pre-installed colour-programmes for an independent stand-alone Mode or operation through the DMX512 protocol. The DMX interface allows lighting systems of any size and can be easily integrated with domotic Systems.

### Max distance between LED driver and RGB products.

Fixture	Max distance from driver
Spike RGB	20m
Spike IP65 RGB	20m
LineaLed RGB	20m
Dedalo RGB	20m

PWM Driver for LED units with pre-installed colour-programmes for an independent stand-alone Mode or operation through the DMX512 protocol. The DMX interface allows lighting systems of any size and can be easily integrated with domotic Systems.

### EXAMPLE OF WI-FI CONTROL OF THE RGB SYSTEM

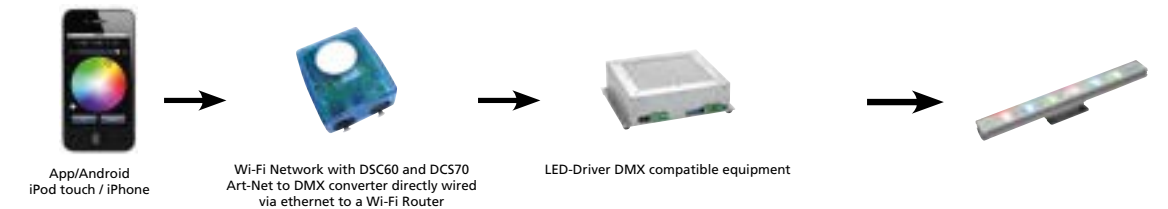

### SPECIAL DEVICES FOR PROJECTS



Code	Description	V IN	DMX Channels	IP	Dimensions
NL78070	Splitter DMX 1 in to 8 out				
DV1044	DMX/RDM Splitter - 4CH DIN-RAIL	12-24-48Vdc	4 x 512	10	79x92x62mm DIN RAIL 4mod.
DV1045	PSU 15W 24Vdc 0.63A (for DV1045)	85-264Vac			17,5x90x54,5mm DIN RAIL 1mod.

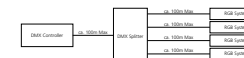

This is a 4 way DMX splitter, features one DMX/RDM input/THRU and 4 DMX/RDM outputs. This unit takes the incoming DMX signal and splits the signal into 4 separate output channels. Each output channel and the input channel are completely electronically isolated from each other, all channels have independent line drivers to boost the DMX signal. In addition, the timing of outputs are regenerated in digital mode from a 32bit ARM processor.

The RDM return messages are amplified and redistributed on the other outputs. They can be redistributed on other splitters up to a maximum of 3 different splitter.

## LIGHTING MANAGEMENT

### Dimmer DALI

Code	Description	Signal	V (Vdc)	I (A)	P (W)	L (mm)	W (mm)	H (mm)
NL19090	Dimmer DALI	DALI, Push	10-24	5	120 max	172	42	20 IP20
NL19096	Dimmer Master	DALI, 1-10V; 0-10; Push	12-24	12	288 max	156	52	26 IP20
NL19097	Dimmer SLAVE + NL19096	DALI, 1-10V; 0-10; Push	12-24	12	288 max	156	52	26 IP20

↳ CODES INDEX

Table with 4 columns of codes and numbers. Includes codes like 0112010A, 0116010A, 0117010A, etc., and numbers like 745, 746, 747, etc.

↳ CODES INDEX

Table with 4 columns of codes and numbers. Includes codes like AF46104, AF46105, AF46201, etc., and numbers like 223, 224, 225, etc.

CODES INDEX

Table with 5 columns of alphanumeric codes ranging from AQ26101 to AQ37004.

CODES INDEX

Table with 5 columns of alphanumeric codes ranging from AT10500APP to AT21304.

↶ CODES INDEX

Table with 5 columns: Code, Value 1, Value 2, Value 3, Value 4. Contains a comprehensive list of codes and their corresponding values, such as DG12700F09, DG12700F10, DG12700G09, etc.

↶ CODES INDEX

Table with 5 columns: Code, Value 1, Value 2, Value 3, Value 4. Contains a comprehensive list of codes and their corresponding values, such as M325200, M325200, M325200, etc.



## Headquarters

**Artemide S.p.A.**  
Via Bergamo, 18  
20010 Pregnana Milanese (MI), Italy  
Tel. +39 02 93518.1 - 93526.1  
Numero verde 800 834 093  
(from Italy only)  
info@artemide.com  
www.artemide.com

## Communication and Marketing Department

Via Canova, 34  
20145 Milan (MI), Italy  
Tel. +39 02.349611  
communication@artemide.com  
www.artemide.com

## Italy

**Head office:**  
**Artemide Italia s.r.l.**  
Via Bergamo 18  
20010 Pregnana Milanese (MI)  
Tel. +39 02 93518 1  
Tel. +39 02 93526 1  
Numero Verde 800 834 093  
artemideitalia@artemide.com

**Milano Monforte Showroom:**  
Corso Monforte 19, 20122 Milano  
Tel. +39 02 76006930  
Tel. +39 02 794039  
monforte@artemide.com

**Milano Manzoni Showroom:**  
Via Manzoni 12, 20121 Milano  
Tel. +39 02 778712201  
Tel. +39 02 778712202  
manzoni@artemide.com

**Milano Danese Showroom:**  
Piazza San Nazaro in Brolo 15,  
20122 Milano  
Tel. +39 02 58304150  
showroomdanese@artemide.com

**Roma Margutta Showroom:**  
Via Margutta 107, 00187 Roma  
Tel. +39 06 36001802  
Tel. +39 06 36001808  
margutta@artemide.com

**Treviso Showroom:**  
Via Campana 47  
ang. Piazza San Francesco,  
31100 Treviso  
Tel. +39 0422 410115  
treviso@artemide.com

**Milano Lighting Consultancy Center:**  
Via Manzoni 12, 20121 Milano  
Tel. +39 02 778712201  
Tel. +39 02 778712202  
manzonilighting@artemide.com

**Roma Lighting Consultancy Center:**  
Via Pisanelli 1, 00196 Roma  
Tel. +39 06 94537550  
pisanelli@artemide.com

## Europe

**Albania**  
**Principal dealer:**  
A Bi Esse  
Rr. 28 Nentori Nr. 73  
1051 Kashar, Tirana  
Tel. +355 42 407290  
Tel. +355 69 4065800  
info@abiesses.al

**Austria**  
**Head office and Showroom:**  
Artemide Handelsgesellschaft m.b.H.  
Gonzagagasse 1 / Morzinplatz  
1010 Wien  
Tel. +43 (0)1 803 21 82  
info@artemide.at

**Azerbaijan**  
**Principal dealer:**  
Studio 151  
Port Baku Residence  
Uzeyir Hacıbəyov str. 151,  
1001 Baku  
Tel. +994 12 599 2040/41  
studio151@office.az

**Belarus**  
**Sales Offices:**  
Artemide HUB  
Borislava Pekica 14  
11000 - Belgrade  
Tel. +39 0331 1818703 (Italy)  
Tel. +381 11 4041899 (Serbia)  
mail@artemidehub.com

**Denmark**  
**Head Office & Showroom:**  
Artemide Scandinavia A/S  
Skudehavnsvej 5  
DK-2150 Copenhagen  
Tel. +45 7020 1700  
info@artemide.dk

**Estonia**  
**Sales Offices:**  
Artemide HUB  
Borislava Pekica 14  
11000 - Belgrade  
Tel. +39 0331 1818703 (Italy)  
Tel. +381 11 4041899 (Serbia)  
mail@artemidehub.com

**Brussels showroom and Lighting Consultancy Center:**  
Chaussée de Waterloo 410  
1050 Brussels - Belgium  
Tel. +32 02 534 03 67  
artemide.brussels@skynet.be

**Amsterdam showroom and Lighting Consultancy Center:**  
Hobbemakade 89,  
1071 XR Amsterdam Holland  
Tel. +31 20 4702668  
artemide.amsterdam@artemide.nl

**Bosnia and Herzegovina**  
**Sales Offices:**  
Artemide HUB  
Borislava Pekica 14  
11000 - Belgrade  
Tel. +39 0331 1818703 (Italy)  
Tel. +381 11 4041899 (Serbia)  
mail@artemidehub.com

**Bulgaria**  
**Sales Offices:**  
Artemide HUB  
Borislava Pekica 14  
11000 - Belgrade  
Tel. +39 0331 1818703 (Italy)  
Tel. +381 11 4041899 (Serbia)  
mail@artemidehub.com

**Czech Republic**  
**Principal dealer:**  
Selene spol. s.r.o.  
Neumannova 161, 3  
83 01 Prachatice  
Tel. +420 388 310 326  
info@selene.cz

**Showroom:**  
Myslikova 9  
Praha 1 110 00

**Cyprus**  
**Sales Offices:**  
Artemide Hellas S.A.  
34, Solonos St.  
106 73 Athens  
Tel. +30 210 3646770  
info@artemide.gr

**Croatia**  
**Sales Offices:**  
Artemide HUB  
Borislava Pekica 14  
11000 - Belgrade  
Tel. +39 0331 1818703 (Italy)  
Tel. +381 11 4041899 (Serbia)  
mail@artemidehub.com

**France**  
**Head Office and Showroom:**  
Artemide France S.A.S.  
52, avenue Daumesnil,  
75012 Paris  
Tel. +33 01 43 44 44 44  
artemide@artemide.fr

**Finland**  
**Head Office:**  
Artemide Scandinavia A/S  
Skudehavnsvej 5  
DK-2150 Copenhagen  
Tel. +45 7020 1700  
info@artemide.dk

**Germany**  
**Head office and Showroom:**  
Artemide Deutschland GmbH & Co. KG  
Hans-Böckler-Straße 2  
58730 Fröndenberg  
Tel. +49 (0)2373 975 0  
info@artemide.de

**Artemide München Lighting Consultancy Center:**  
Luise-Ullrich-Straße 20,  
80636 München  
Tel. +49 (0) 89 70065198  
muenchen@artemide.de

**Frankfurt Showroom:**  
Baseler Straße 10  
60329, Frankfurt  
Tel. +49 (0)69 33 99 569 0  
frankfurt@artemide.de

**Greece**  
**Head office:**  
Artemide Hellas S.A.  
34, Solonos St.  
106 73 Athens  
Tel. +30 210 3646770  
info@artemide.gr

**North Greece Branch Offices & Showroom:**  
92, G. Papandreou St.  
546 65 Thessaloniki  
Tel. +30 2310 403934  
thessaloniki@artemide.gr

**Hungary**  
**Principal dealer and Showroom:**  
Rio Lámpastúdió Kft.  
Ráday u. 45.  
H-1092 Budapest  
Tel. +36 1 323 1637  
rio@lampastudio.hu

**Ireland**  
**Sales Offices:**  
Artemide GB Ltd.  
Tel. +44 20 7631 5200  
info@artemide.co.uk

**Kosovo**  
**Principal dealer:**  
Light House Studio  
Veternik nn, 1000 Prishtine  
Tel. +386 43 733 333  
info@lighthouse-kos.com

**Latvia**  
**Sales Offices:**  
Artemide HUB  
Borislava Pekica 14  
11000 - Belgrade  
Tel. +39 0331 1818703 (Italy)  
Tel. +381 11 4041899 (Serbia)  
mail@artemidehub.com

**Lithuania**  
**Sales Offices:**  
Artemide HUB  
Borislava Pekica 14  
11000 - Belgrade  
Tel. +39 0331 1818703 (Italy)  
Tel. +381 11 4041899 (Serbia)  
mail@artemidehub.com

**Lithuania**  
**Sales Offices:**  
Artemide HUB  
Borislava Pekica 14  
11000 - Belgrade  
Tel. +39 0331 1818703 (Italy)  
Tel. +381 11 4041899 (Serbia)  
mail@artemidehub.com

**Lithuania**  
**Sales Offices:**  
Artemide HUB  
Borislava Pekica 14  
11000 - Belgrade  
Tel. +39 0331 1818703 (Italy)  
Tel. +381 11 4041899 (Serbia)  
mail@artemidehub.com

**Malta**  
**Head Office:**  
Artemide Italia S.r.l.  
Tel. +39 02 93518 1  
artemideitalia@artemide.com

**Moldova**  
**Sales Offices:**  
Artemide HUB  
Borislava Pekica 14  
11000 - Belgrade  
Tel. +39 0331 1818703 (Italy)  
Tel. +381 11 4041899 (Serbia)  
mail@artemidehub.com

**Montenegro**  
**Sales Offices:**  
Artemide HUB  
Borislava Pekica 14  
11000 - Belgrade  
Tel. +39 0331 1818703 (Italy)  
Tel. +381 11 4041899 (Serbia)  
mail@artemidehub.com

**Norway**  
**Distributor:**  
Limelight AS  
Sandakerveien 24C, inng. D9  
No-0473 Oslo  
Tel. +47 4000 1589  
info@limelight.no

**Poland**  
**Head Office:**  
Artemide Dystrybucja Polska  
sp. z o.o.  
Ul. Saperow 4, 82-300 Elblag  
Tel. +48 55 236 11 85  
info@liralighting.pl

**Portugal**  
**Principal Dealer:**  
Fluxograma S.A.  
Rua da Garagem nº3  
2794-021 Carnaxide  
Tel. +351 214 257 500  
fluxograma@fluxograma.com

**Romania**  
**Sales Offices:**  
Artemide HUB  
Borislava Pekica 14  
11000 - Belgrade  
Tel. +39 0331 1818703 (Italy)  
Tel. +381 11 4041899 (Serbia)  
mail@artemidehub.com

**Russia**  
**Head office:**  
Artemide Agency OOO  
Bolshoj Zlatoustinskij Pereulok,  
bldg 1/1, office 103  
101000 Moscow  
Tel. +7 495 984 2238  
info@artemide-agency.ru

**Slovakia**  
**Principal dealer:**  
Akl s.r.o.  
Vietnamská 45  
82104 Bratislava  
Tel. +421 907 767 008  
info@aklsro.sk

**Slovenia**  
**Sales Offices:**  
Artemide HUB  
Borislava Pekica 14  
11000 - Belgrade  
Tel. +39 0331 1818703 (Italy)  
Tel. +381 11 4041899 (Serbia)  
mail@artemidehub.com

**Spain**  
**Sales Office, Showroom and Lighting Consultancy Center:**  
Artemide S.A.  
C/Vico, 12-18 bajos  
08021 Barcelona  
Tel. +34 093 478 3911  
artemide@artemide.es

**Sweden**  
**Head office:**  
Artemide Scandinavia A/S  
Skudehavnsvej 5  
DK-2150 Copenhagen  
Tel. +45 7020 1700  
info@artemide.dk

**Switzerland**  
**Artemide Lighting Consultancy Center:**  
Albulastraße 60  
8048 Zürich  
Tel. +41 (0)43/ 268 27 27  
info@artemide.ch

**Turkey**  
**Principal dealer:**  
Oztaş Aydınlatma  
Yskender Cad., 24  
34420 Istanbul - Sishane  
Tel. +90 212 237 52 36  
info@oztasaydinlatma.com

**Ukraine**  
**Sales Offices:**  
Artemide HUB  
Borislava Pekica 14  
11000 - Belgrade  
Tel. +39 0331 1818703 (Italy)  
Tel. +381 11 4041899 (Serbia)  
mail@artemidehub.com

**United Kingdom**  
**Head office, Showroom and Lighting Consultancy Center:**  
Artemide GB Ltd.  
106 Great Russell Street  
London WC1B 3NB  
Tel. +44 20 7631 5200  
info@artemide.co.uk

For information regarding distributors and points of sale in countries not listed in these pages, please visit our website [artemide.com](http://artemide.com) or email: [info@artemide.com](mailto:info@artemide.com)

## America

### Canada

**Head office:**  
Artemide Ltée/Ltd.  
11105, rue Renaude Lapointe  
Montréal, Québec H1J 2T4  
Tel. +1 514 323 6537  
Toll free +1 888 777 2783  
infocanada@artemide.net  
www.artemide.net

**Flagship Store:**  
Toronto, ON  
5 Mill Street  
Toronto, Ontario M5A 3R6  
Tel. +1 416 628 6718  
torontoshowroom@artemide.net

**Sales offices:**  
Toronto, ON  
Tel. +1 416 628 6718  
torontoshowroom@artemide.net

### U.S.A.

**Headquarters:**  
Artemide, Inc.  
250 Karin Lane  
Hicksville, NY 11801  
Tel. +1 631 694 9292  
Toll free +1 877 Art 9111  
infousa@artemide.net  
www.artemide.net

**Flagship stores:**  
**Chicago, IL**  
351 W Hubbard street  
Chicago, IL 60654  
Tel. +1 312 475 0100  
chicagoshowroom@artemide.net

**New York, NY**  
46 Greene Street  
New York, NY 10013  
Tel. +1 212 925 1588  
newyorkshowroom@artemide.net

**Sales offices:**  
**Chicago, IL**  
Tel. +1 312 475 0100  
chicagoshowroom@artemide.net

**Miami, FL**  
Tel. +1 305 444 5800  
miami@artemide.net

**New York, NY**  
Tel. +1 212 925 1588  
newyorkshowroom@artemide.net

**San Francisco, CA**  
Tel. +1 415-393-9955  
sanfrancisco@artemide.net

For information regarding distributors and points of sale for Central & South American countries not listed, please email:  
infolatam@artemide.net

### Central & South America

**Argentina**  
**Distributor:**  
**Head Office & Showroom:**  
Edimetra S.A.  
Paraguay 792 3° Piso  
1057 Buenos Aires  
Tel. +54 11 4312-2590  
info@artemide.com.ar

**Bolivia**  
**Showroom:**  
Studio Tessuto  
Local 103, Urubó Business Center  
Santa Cruz, Bolivia  
Tel. +591 3 321 6313  
info@studiotessuto.com

**Brasil**  
**Distributor:**  
**Head Office & Showroom:**  
Cynthron  
Rua do Rócio, 423, 18° andar,  
Vila Olimpia  
04552 000, São Paulo  
Tel. +55 11 3846 8100  
cynthron@cynthron.com.br

**Chile**  
**Showroom:**  
Interdesign  
Isidora Goyenechea 3200  
Las Condes, Santiago  
Tel. +56 2 22314114  
info@interdesign.cl

**Colombia**  
**Showroom:**  
Milk Luminance  
Cra 43-A #11B-95  
Medellin  
Tel. +57-(4) 448 5583  
Tel. +57 31130 15090  
info@milk.com.co  
www.milk.com.co

**Costa Rica**  
**Showroom:**  
Alumimundo, S.A  
Apt. 1013 Diagonal Oficinas  
Centrales de Pizza HutPavas,  
San Jose  
Costa Rica 1013-1000 S.J.  
Tel. +506 4101-8600  
www.alumimundo.com

**Dominican Republic**  
**Distributor:**  
Spazio di Casa  
Ave. Max Henriquez Ureña, N°17  
Ensanche Naco, Santo Domingo  
Tel. +1 809 368 2001  
info@spaziodicasa.com

**Ecuador**  
**Showroom:**  
Integral Iluminacion Km. 2.5  
Via Samborondon Tornero 3 Mz.  
Solar 5, Guayaquil-Ecuador  
Tel. +593 4 6000 622  
info@integral.com.ec  
www.integral.com.ec

**Guatemala**  
**Showroom:**  
D'illuminazione Diagonal 6 12-42  
Zona 10 Edificio Design Center  
Oficina #220  
Guatemala City, Guatemala  
Tel. +502-2458-4404  
www.dilluminazione.com

**Nicaragua**  
**Showroom:**  
Michel Pierson  
Edificio CAR 3, 2da planta  
Planes de Altamira  
Managua, Nicaragua  
Tel. +505 2299 3936  
Tel. +505 2299 3937  
www.michelpierson.com.ni

**Mexico**  
**Distributor:**  
**Head Office, Showroom & Customer Service:**  
Scultura Luminosa  
Suderman #246,  
Col. Chapultepec Morales  
Mexico D.F. 11570  
Tel. +52 55 5250 2661  
info@artemide.mx

**Panama**  
**Showrooms:**  
Idea Design Center  
Av. Samuel Lewis con Calle 59  
Kenex plaza, Obarrio, Panama City  
Rep. de Panama  
Tel. +507 216 90 67  
info@ideapanama.com

Lumicentro  
Ave. Justo Arosemena,  
Esquina Calle 33  
Ave. Ecuador. Edificio Lumicentro  
Apartado 0816-01064  
Panama City, Rep. de Panama  
Tel. +507 300 2400  
info@lumicentro.com

**Peru**  
**Showroom:**  
Hilite  
Av. Los Conquistadores 575  
San Isidro, Perú  
Tel. +511 422 9123  
ventas@hiliteperu.com

**Puerto Rico**  
**Distributor:**  
San Juan Lighting  
1519 Parana Street San Juan  
Puerto Rico 00926-2814  
Tel. +1 (787) 767-7286  
slj@sanjuanlighting.com  
www.sanjuanlighting.com

**Uruguay**  
**Showroom:**  
TRIOS Lighting  
Luis de la Torre 593b  
Montevideo, Uruguay  
Tel. +598 2711 9260  
info@trioslighting.com

**Venezuela**  
**Showroom:**  
Iluminación HELIOS  
Av. San Felipe, Centro Coinasa,  
Mezzanina La Castellana, Caracas  
1060, Venezuela  
Tel. +58 212 265 58 83  
informacion@helios.com.ve

## Asia / Oceania

### Australia

**Head office and Showroom:**  
**Adelaide**  
Ornare Imports Pty. Ltd.  
28 Fullarton Rd, Norwood SA 5067  
Tel. +61 08 8362 3029  
info@artemide.com.au  
www.artemide.com

**Office and Showrooms:**  
**Sydney**  
504-508 Cleveland St.  
Surry Hills NSW 2010  
Tel. +61 02 9699 8472  
sydney@artemide.com.au

**Melbourne**  
46-48 Rathdowne St.  
Carlton VIC 3053  
Tel. +61 03 9349 3310  
melbourne@artemide.com.au

**China**  
**Head office:**  
Artemide Trading  
(Shanghai) Co., Ltd.  
Room 1907, 19/F, New Hualian  
Mansion, East Wing,  
755 Middle Huai  
Hai Road, Huang Pu District,  
Shanghai  
Tel. +86 21 6448 3650  
info@artemide.cn

**Affiliated Showrooms:**  
**Beijing**  
Unit 1-B-20, International Furniture,  
Hall 1, Easy Home, No. 65 North 4th  
Ring Road, Chaoyang District,  
Beijing  
Tel. +86 010 8463 6098  
jinhongshijia@126.com

A81112, 1st Floor, Red Star Macalline  
N°.193 East 4th Ring Road  
Chaoyang District, Beijing  
Tel. +86 010 8511 8718

### Hong Kong and Macao

**Head Office:**  
Artemide Ltd.  
Unit 1303, 13/F, Ruttonjee House  
Ruttonjee Centre, 11 Duddell Street  
Central, Hong Kong  
Tel. +852 2523 0050  
info@artemide.com.hk

**Showroom:**  
Shop 102-103, Ruttonjee Centre,  
11 Duddell Street,  
Central, Hong Kong  
Tel. +852 2523 0333

### India

**Head office:**  
Artemide Lighting India Pvt. Ltd.  
Unit N°. 5, 2<sup>nd</sup> floor, Raghuvanshi  
Mills Compound, Senapati Bapat  
Marg, Lower Parel, Mumbai  
400013, Maharashtra  
Tel. +91 22 61774800  
Tel. +91 9953554435  
info@artemide.in  
anindya@artemide.in

**Region: West**  
**Showroom and Registered Office:**  
Unit N°. 5, 2nd floor, Raghuvanshi  
Mills Compound, Senapati Bapat  
Marg, Lower Parel, Mumbai  
400013, Maharashtra  
Tel. +91 9920628841  
Tel. +91 22 61774800  
pramod.tambe@artemide.in  
anindya@artemide.in  
arun.khattri@artemide.in

**Region: South**  
Tel. +91 9312829394  
Tel. +91 9538998132  
arun.khattri@artemide.in  
ravi@artemide.in

**Region: Delhi NCR**  
**Showroom:**  
N°.5, Retreat Farms, Khullar Farms,  
Ashok Lane, Mandi Road, Mehrauli  
New Delhi - 110030  
Tel. +91 9811163966  
Tel. +91 9810945899  
Tel. +91 8447147522  
ashwani.gupta@artemide.in  
dheeraj.kapoor@artemide.in  
sumit@artemide.in

**Region: North**  
Tel. +91 9811163966  
Tel. +91 9810945899  
ashwani.gupta@artemide.in  
dheeraj.kapoor@artemide.in

**Region: East**  
Tel. +91 9312829394  
Tel. +91 9811163966  
arun.khattri@artemide.in  
ashwani.gupta@artemide.in

**Indonesia**  
**Sales Offices:**  
Artemide Ltd.  
Tel. +852 2523 0050  
info@artemide.com.hk

**Japan**  
**Head office:**  
Artemide Japan K.K.  
#2013 1-41-7 Tomigaya Shibuya-ku  
151-0063 Tokyo Japan  
Tel. +81 3 5738 7410  
info@artemide.co.jp

### Malaysia

**Distributor:**  
Lightcraft (KL) Sdn Bhd  
145-5&6, Jalan Sungai Besi,  
57100 Kuala Lumpur, Malaysia  
Tel. +603 9222 4219  
info@lightcraft.com.my

**New Zealand**  
**Distributor:**  
ECC Lighting  
39 Nugent Street, Auckland  
Tel. +64 9 379 9680  
info@ecc.co.nz

61 Thorndon Quay  
Tel. +64 4 473 3456  
Wellington  
info@ecc.co.nz

**Philippines**  
**Sales Offices:**  
Artemide Ltd.  
Tel. +852 2523 0050  
info@artemide.com.hk

**Singapore**  
**Distributor:**  
Million Lighting Co Pte Ltd  
203 Kallang Bahru  
Million Building, Singapore 339340  
Tel. +65 6743 2033  
enquiry@millionlighting.com  
showrooms@millionlighting.com  
www.millionlighting.com

**South Korea**  
**Distributor:**  
Duomo & Co.  
735, Nonhyun-ro, Gangnam-gu  
Seoul, Korea  
Tel. +82 2 516 7083  
info@duomokorea.com  
www.duomokorea.com

**Thailand**  
**Sales Offices:**  
Artemide Ltd.  
Tel. +852 2523 0050  
info@artemide.com.hk

**Taiwan**  
**Distributor:**  
Mithus Co. Ltd.  
4F, No. 236, Liancheng Rd.,  
Zhonghe Dist. New Taipei City  
23553, Taiwan  
Tel. +886 2 2221 1668  
allen.chang@bravocasa.com.tw  
www.mithus.tw

**Vietnam**  
**Distributor:**  
Cao Tran Co., Ltd  
23 Tran Phu, P4-Q.5  
Ho Chi Minh City, Vietnam  
Tel. +84 8 3833 3334  
caotran@cara.com.vn  
www.cara.com.vn

## Middle East & Africa

**Head office & Showroom:**  
Artemide Middle-East  
Dubai Design District (D3)  
Building 6 - 3rd Floor - Offices A307  
Dubai, UAE  
Tel. +971 4 425 0213  
info@artemide.ae

For information regarding distributors and points of sale for Middle East & Africa countries, please email:  
info@artemide.ae

© Artemide S.p.A.

Art direction & editing  
Studio de Bevilacqua  
Carlotta de Bevilacqua  
MISCENT

with  
Ippolita Ciampini  
Diego Martinelli  
Alessandra De Vecchi

Image editing  
and 3D visualization  
Giona Andreani  
Simone Fantoni  
Alessandro Peccati

Still lifes  
Jean Pierre Maurer  
Manuel Maurer  
Gio Pini  
Federico Villa  
Miro Zagnoli  
Michele Nastasi

Prepress  
Actualtype s.r.l.

Press  
Rotolito Lombarda



Compasso D'oro  
1967-1989-1994-2004 -2018



Winner European  
Design Prize '97



**ISO 9001:2008**



**ISO 14001:2004**



BIAN CARBONE



**CTF STAGE2  
ISO 17025**

Artemide S.p.A.  
reserves the right to change, at any time  
and without prior warning, the technical  
specifications of any product illustrated  
in this catalogue.